

NACHI

**CUTTING
TOOLS**

DRILLS

ENDMILLS

TAPS

NACHI

Contributing to Progress in the World of Product Manufacture

The NACHI Difference:

NACHI-FUJIKOSHI CORP. is a pioneer of precision cutting tools in Japan and one of the leading manufacturers of tools worldwide. No manufacturer of cutting tools anywhere in the world exercises greater control over the quality of its products than NACHI. NACHI quality starts with the material itself because the High Speed Steel, premium Cobalt High Speed Steel, Powder High Speed, and Cermet we use comes from our own mills. The technology of the coating, such as Mixed Component multi-layer coating and Diamond coating (thin film diamond) has been developed specifically for our cutting tools.

Cutting tools are basic products for the machine industries. Successful performance of machine tools cannot be expected without precise cutting tools and high quality. NACHI pursues the highest quality 100% of the time. NACHI is the first Japanese cutting tool manufacturer to be awarded the prestigious honor of the Deming Award for Quality.

When You Buy From NACHI:

When you purchase cutting tools from NACHI you are using products produced by one of the largest, most innovative manufacturers of industrial equipment in the world. Established more than 75 years ago, The NACHI-FUJIKOSHI CORP. has grown into a world-class, worldwide leader in its industry. The company has approximately ten million square feet of plant area and facilities in Japan, Production plants in The U.S.A., Singapore, Brazil, Taiwan, Spain and Korea, and sales marketing subsidiaries in all major industrial nations.

NACHI-FUJIKOSHI CORP.

We have a history of Seventy five years as a world-famous integrated manufacturers with the renowned brand "NACHI". With the continuous production system, from high class special steels to finished products, our well-coordinated technics stand high in public estimation.



Head Office: Toyama Plant

JAPAN MAIN OFFICE

Shiodome Sumitomo Bldg. 17F, 1-9-2 Higashi-Shinbashi,
Minato-ku, Tokyo JAPAN, 105-0021
Phone: (03)5568-5111
Fax: (03)5568-5206

Overseas Subsidiary Companies

NACHI AMERICA INC. HEADQUARTERS

713 Pushville Road, Greenwood, Indiana 46143, U.S.A.
Phone: (317)530-1001 Fax: (317)530-1011

NACHI CANADA INC.

89 Courtland Ave., Unit No. 2, Concord, Ontario L4K 3T4, CANADA
Phone: (905)660-0088 Fax: (905)660-1146

NACHI MEXICANA, S.A. DE C.V.

Urbina No.54, Parque Industrial Naucalpan, Naucalpan de Juarez,
Estado de Mexico C.P. 53370, MEXICO
Phone: +52-55-3604-0832/0842/0081 Fax: +52-55-3604-0882

NACHI EUROPE GmbH

Bischofstrasse 99, 47809, Krefeld, GERMANY
Phone: (02151)65046-0 Fax: (02151)65046-90

NACHI TECHNOLOGY (THAILAND) CO., LTD.

5/5 M, 2, Rojana Industrial Estate Nongbua,
Ban Khai, Rayong, 21120, THAILAND
Phone: (38)961-682 Fax: (66)38-961-683

NACHI SINGAPORE PTE. LTD.

No. 2 Joo Koon Way, Jurong Town, Singapore
628943, SINGAPORE
Phone: 65587393 Fax: 65587371

NACHI (SHANGHAI) CO., LTD.

Yitong Industry Zone 258, Fengmao Rd. Malu Town,
Jiading, Shanghai 201801, CHINA
Phone: +86-(0)21-6915-2200 Fax: +86-(0)21-6915-5427

NACHI (AUSTRALIA) PTY. LTD.

(SYDNEY HEAD OFFICE)
Unit 1, 23-29 South Street, Rydalmere, N.S.W. 2116, AUSTRALIA
Phone: (02)9898-1511 Fax: (02)9898-1678

FUJIKOSHI-NACHI (MALAYSIA) SDN. BHD.

No. 17, Jalan USJ 21/3, 47630 UEP Subang
Jaya, Selangor Darul Ehsan, MALAYSIA
Phone: 03-80247900 Fax: 03-80235884

Overseas Plants

NACHI TECHNOLOGY INC.

713 Pushville Road, Greenwood, Indiana 46143, U.S.A.
Phone: (317)535-5000 Fax: (317)535-8484

NACHI TOOL AMERICA INC.

713 Pushville Road, Greenwood, Indiana 46143, U.S.A.
Phone: (317)535-0320 Fax: (317)535-0983

NACHI BRASIL LTDA.

Avenida João XXIII, No. 2330, Jardim São Pedro,
Mogi das Cruzes, S.P., BRASIL, CEP 08830-000 Caixa Postal 2505
Phone: (011)4793-8800 Fax: (011)4793-8870

NACHI INDUSTRIES PTE. LTD.

No. 2 Joo Koon Way, Jurong Town, Singapore 628943, SINGAPORE
Phone: 6861-3944 Fax: 6861-1153

NACHI PILIPINAS INDUSTRIES, INC.

1ST Avenue, Manalac Compound, Sta. Maria
Industrial Estate, Bagumbayan, Taguig Metro Manila, PHILIPPINES
Phone: (02) 838-3620 Fax: (02) 838-3623



Higashi - Toyama, Steel Plant



Namerikawa Plant



NACHI AMERICA INC.



Brazil Plant

NACHI

Technical Data

DRILLS

DRILLS
Cutting Condition

END MILLS

END MILLS
Cutting Condition

TAPS

TAPS
Cutting Condition

Others

Clean Steel

Material and heat treatment are major factors in determining the performances of the HSS tool. To provide high-quality HSS tools, NACHI-FUJIKOSHI has a steel mill to manufacture the HSS steels conforming to individual requirements for our in-house use as well as for outside sales.



Electric arc furnace

Clean Heat Treatment

In the field of heat treatment, we are producing and marketing vacuum heat treatment furnaces, which are highly evaluated among users both in Japan and abroad. Further, through technical tie-ups with Sumitomo Electric Industries Co., Ltd., we use cemented carbide materials best suited to individual requirements.

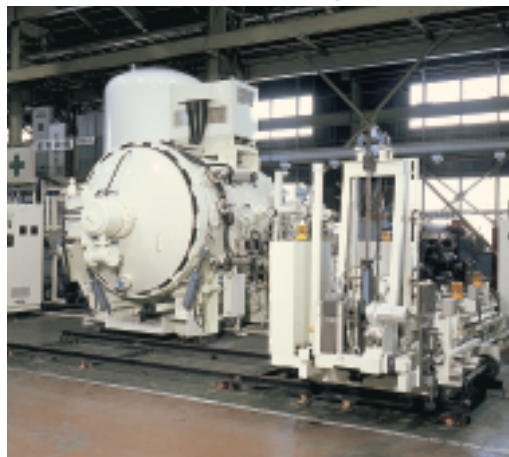

Horizontal type one chamber gas pressure quenching vacuum furnace

High-speed tool

Main high-speed tools and their applications

Classification	Steel type symbol			Chemical component						Application
	JIS	AISI	NACHI	C	Mo	W	Cr	V	Co	
High-speed steel	SKH10	T 15	HS55T	1.5		12	4	5	5	Basic steel type, cutting tool Drill, broach, others in general Drill, gear cutting tool, others in general Cutting tool, others in general Cutting tool, others in general Tool material End milling cutter and others End milling cutter, tap
	SKH51	M 2	SKH51	0.85	5	6	4	2		
	—	M33	HM33	0.9	9.5	1.5	4	1.2	8	
	—	M34	HM34	0.9	8	2	4	2	8	
	SKH55	M35	HS53M	1.05	5.5	6	4	2.5	5	
	SKH57	—	HS93R	1.25	3.5	10	4	3.5	10	
	SKH59	M42	HS96H	1.1	9.5	1.5	4	1.2	8	
Powdered High-speed steel			HS97R	1.1	5.5	7.5	4	1.8	9	Saws and others General Gear cutting tool, tap, others in general Gear cutting tool, broach, others in general General (high alloy material)
			FAX18	1.1	9.5	1.5	4	1.2	8	
			FAX31	1.3	5.5	6	4	3	3	
			FAX38	1.3	5	6	4	3	8	
			FAX55	1.6		12	4	5	5	
Alloy tool steel			FAX90	2.6	3.5	10	4	8.5	10	Hack saw, etc.]Molding tools including dies and molds
	SKS 7		SKS 7	1.15		2.2	0.3			
	SKD11		SKD11	1.5	1		12	0.4		
	SKD61		SKD61	0.4	1.3		5	1	Si	

Effects of major alloy components

- W : Hard double carbide is formed to ensure improved wear resistance
- Mo : Fine carbide and improved toughness to ensure improved wear resistance
- Cr : Tissue stabilization factor (upgraded solubility)

- V : Extended and improved wear resistance of secondary carbon
- C : Enhanced carbon formation factor and hardening properties
- Co : Best suited to heavy-duty cutting due to improved heat resistance

Characteristic of various tool materials

It is important that tool materials are characterized by excellent resistance to chipping or breakage. Selection is made from among various types of tool materials in conformity to the workpiece and machining method. NACHI's integrated production system covering the entire range from materials to tool produces provides tool materials meeting each of your requirements.

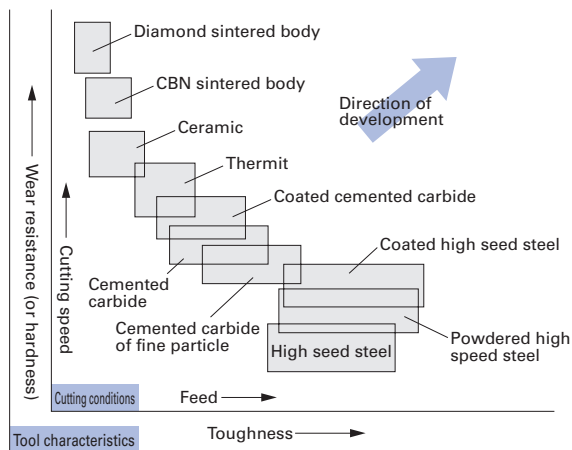

Characteristics of various tool materials

Type	Symbol	(Example)	Production method	Features
Carbon tool steel	SK □	SK 3	Tool steel where carbon is put into iron to enable hardening.	Less expensive, but low hardness at a high temperature.
Alloy tool steel	SKS □ SKD □	SKS 7 SKD 11	Tool steel with its wear resistance improved by alloy steel such as iron, Cr and W.	
High speed steel	SKH □	SKH 51 SKH 55	Tool steel with wear resistance and toughness improved by hard carbide created by mixing W, Mo, Cr and V with iron.	The steel type with much Co content is called cobalt high speed tool characterized by excellent heat resistance.
Powdered high speed steel	NACHI symbol FAX □	FAX 38 FAX 55	Fine powder of the high speed steel sintered by the powder metallurgy. This method can also be used to manufacture the type of steep containing such components as V and Co.	The tissue is minute, uniform and tough. Further, excellent wear resistance is provided by such components.
Cemented carbide	K □ P □	K 10 P 20	The major component is W. It is manufactured by sintering the TiC, TaC and Co (bonding agent) according to powder metallurgy method.	Very hard at a high temperature and excellent in wear resistance, but chips easily.
Ultrafine grain cemented carbide	Z □	Z 20	Cemented carbide characterized in that the particle diameter of carbide such as W, Ti and Ta does not exceed 1 micron.	The toughness is higher than that of cemented carbide, but wear resistance is lower.
Thermit	NACHI symbol NAX □	NAX T NAX LL	The main components are carbide such as Ti and Ta, nitride and carbonitride. They are sintered with Ni and Co (binder) by powder metallurgy to produce Thermit.	Excellent in resistance to wear, heat and deposition, but susceptible to chipping. Used for high-speed cutting.
Ceramic			A sintered body (porcelain). Available in two types; alumina type mainly consisting of Al ₂ O ₃ and silicon type mainly consisting of Si ₂ N ₄ .	Excellent wear resistance but poor toughness.
CBN sintered body	NACHI symbol BM □ BC □	BM 10 BC 30B	Manufactured by sintering the powder of CBN, the hardest second only to diamond, at a high temperature under super high pressure. Excellent hardness even at a high temperature.	Reaction with metal occurs very rarely. Characterized by excellent stability at a high temperature.
Diamond sintered body	NACHI symbol DM □	DM 10 DM 10F	A polycrystalline body formed by sintering powdered diamond at a high temperature under super high pressure. Characterized by excellent hardness.	Chemically stable to the workpiece made of other than iron.

Hardness of high-hardness material

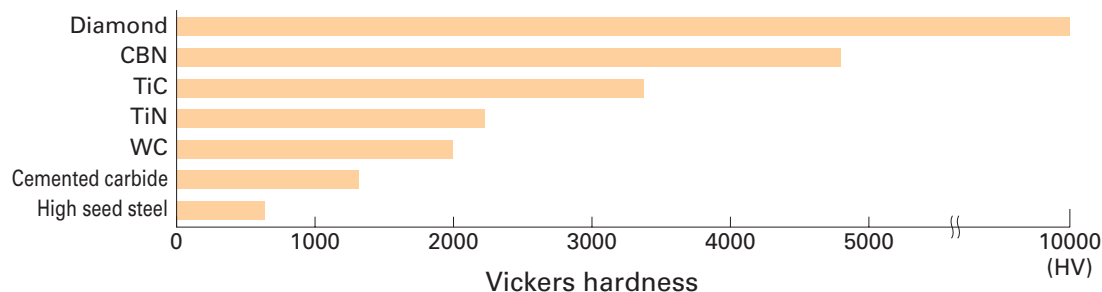

Technical Data

DRILLS

DRILLS
Cutting Condition

END MILLS

END MILLS
Cutting Condition

TAPS

TAPS
Cutting Condition

Others

Technical Data

DRILLS

DRILLS
Cutting Condition

END MILLS

END MILLS
Cutting Condition

TAPS

TAPS
Cutting Condition

Others

Coating Series with Excellent Characteristics

DLC Coating

High-speed dry machining of aluminum alloy has been realized by adoption of cemented carbide alloy and coating of DLC (Diamond-Like Carbon) -- an amorphous substance having diamond-like properties characterized by a high degree of hardness, a low friction coefficient and wear resistance.

It has a low friction coefficient and resistance to deposition of aluminum alloy. Deposition is reduced even in high-speed dry machining, and excellent properties of machining surfaces are provided.

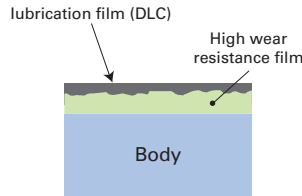

Construction of DLC

	Graphite	DLC	Diamond
Structure			
element	C	C+H	C
R/V	—	1000~8000HV	10000HV

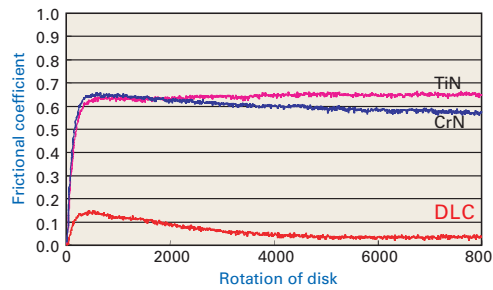

BALL : SUJ2 Disk : Film/HSS (Ry0.2μm)
 Revolution : 500RPM Over weight : 100N Dry
 Machine : CSEM Tribometer

Composite multi-layer coating

As a cutting tool coating technique, this coating technique provides improved wear resistance and ensures protection of the base materials (through the use of a composite multi-layer configuration), centering on the general-purpose TiN G-series. We have established the manufacturing conditions of various series of our company, including the SG series of high-speed steel.

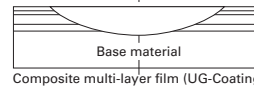
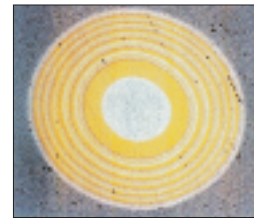

Diamond coating

We are the first in the world to succeed in commercial use of a diamond film (so-called a tool of dream), using our coating technique.

Diamond coating by vapor phase synthetic method provides the close adhesion that has been inconceivable so far. The technique ensures drastic improvement of cutting performance in the field of machining the nonferrous metal, graphite, composite material or aluminum alloy.

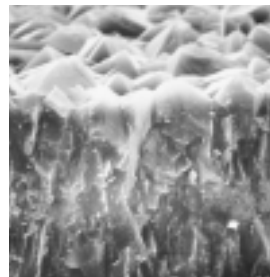

Diamond coated film

Coating equipment

Our R & D efforts cover the development of coating equipment indispensable to the developing of new coating technology.

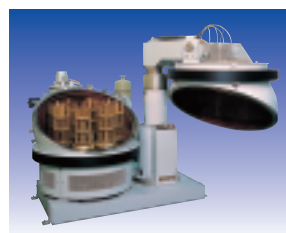

Coating equipment

Comparison of characteristics of NACHI coating film

Name	Evaluation of relative characteristics	Features
G (TiN)		- The basis for PVD coating. Coating method in common use.
SG		- Composite multi-layer film coating method characterized by improved wear resistance as compared to TiN.
UG		- Coating method characterized by adoption of a TiCN based composite multi-layer film to provide improved wear resistance.
AG		- Coating method based on the TiAlN film characterized by superb resistance to heat and wear. Commercialized for use in high-speed steel.
X's		- Coating method for cemented carbide end-milling cutters, based on the TiAlN film characterized by superb resistance to heat and wear.
AQUA		- Coating method characterized by excellent heat resistance and lubricity of the workpiece. Compatible with both dry machining and wet machining.
DLC		- Coating method characterized by a film having a structural characteristic intermediate between graphite and diamond, where the surface is provided with a smooth film, thereby enhancing resistance of aluminum alloy and others to deposition.
DIA		- Coating method best suited to processing of non-ferrous metal, graphite and aluminum alloy, where NACHI is the first to realize commercialization of a diamond film.

Technical Data

DRILLS

DRILLS
Cutting Condition

END MILLS

END MILLS
Cutting Condition

TAPS

TAPS
Cutting Condition

Others

NACHI's Efficiency Theme "Eco & Eco"

Sets The New Standard for Cutting Tools

" ECO " = Economy of Cost Reduction

" ECO " = Ecologically Friendly



Achieving The Cost Efficient Environmentally Friendly Solution

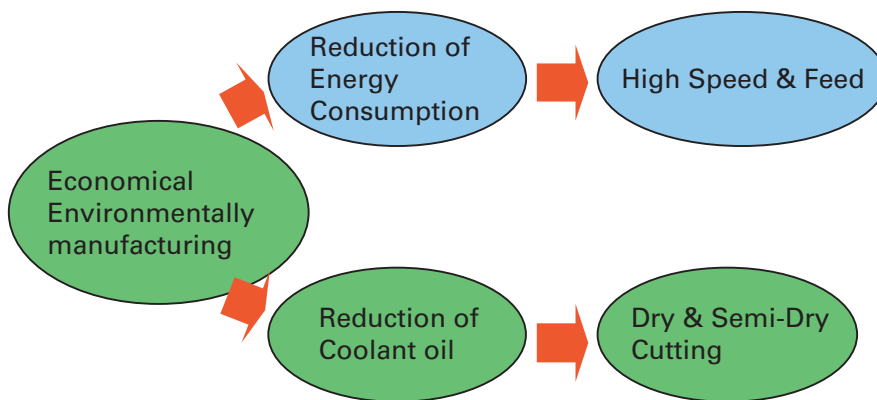

NACHI's Efficient Eco & Eco Lines Dry & Semi-Dry Cutting

Drilling	AQUA Drill Series	for Steel
	DLC Drill Series	for Aluminum
Milling	DLC Endmill Series	for Aluminum
	X's mill GEO Series	for Steel
	X's mill Series	for Steel
Tapping	DLC TAFLET Series	for Aluminum

Technical Data

DRILLS

DRILLS
Cutting Condition

END MILLS

END MILLS
Cutting Condition

TAPS

TAPS
Cutting Condition

Others

**If you can reduce coolant use,
you can reduce cost by more than 16%**

Reducing Machining Costs

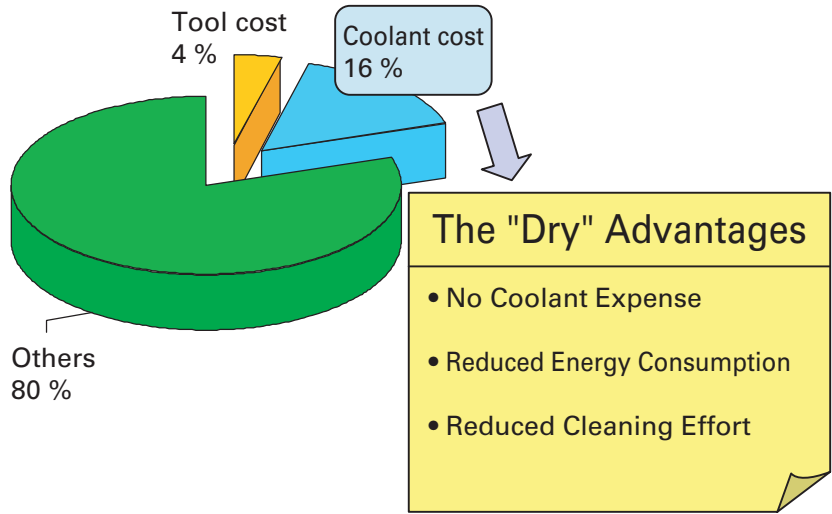

The NACHI Solution

High Speed and Feed Cutting

The Machining Energy Story

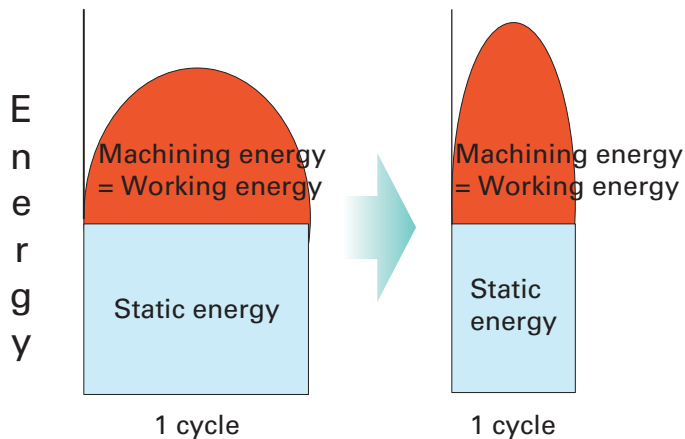

The NACHI Solution
High Speed
& Feed Cutting

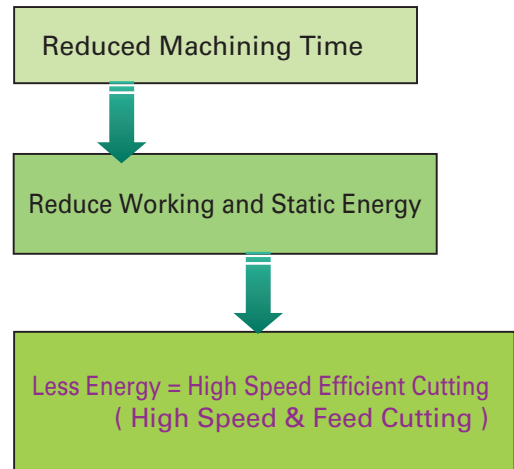

NACHI High Speed & Feed Lines

- Drilling** AQUA Drill Series for Steel
 AG /UG Power Series for Steel
- Milling** X's mill GEO Series
 X's mill Series

Technical Data

DRILLS

DRILLS
Cutting Condition

END MILLS



END MILLS
Cutting Condition

TAPS































TAPS
Cutting Condition

Others

Technical Data
 DRILLS
 DRILLS Cutting Condition
 END MILLS
 END MILLS Cutting Condition
 TAPS
 TAPS Cutting Condition
 Others

	Mark	Explanation		Mark	Explanation
Coating		G (TiN) Coating	Flutes of Drills		Normal Helix Flutes
		UG (TiCN multi layer) Coating			High Helix Flutes
		SG (TiCN multi layer) Coating			Low Helix Flutes
		AG (TiAlN multi layer) Coating	Drill Dimension		Point Angle of Drills
		AQ (TiAlN multi layer) Coating			Drill Length is from Center Point
		X's (TiAlN multi layer) Coating			Drill Length is from Corner Point
		GS (TiAlN multi layer) Coating			Oil-hole Drills
		DLC Coating			Three Flutes Drills
		Diamond Coating	Lip Relief of Drills		Shape of Lip Relief is Conical
	High Speed Steels			Shape of Lip Relief is Two Rake	
	Cobalt High Speed Steels			Shape of Lip Relief is Three Rake	
Tool Materials		Fine Melting HSS	Thinning of Drills		S-type Thinning
		High Grade Powder HSS			Notch Thinning
		Vanadium HSS			X-type Thinning
		Vanadium HSS			
		Cobalt/Vanadium HSS			XH-type Thinning
		Tungsten Carbide			2Rake Relief & X-type Thinning
					2Rake Relief & XR-type Thinning
					3 Flutes Drills & 3F-type Thinning

GUIDE TO MARK (TOOL SPECIFICATION)

	Mark	Explanation		Mark	Explanation	
Tolerance of Drills Dia.	js6	Tolerance of Drills Diameter is js6	Flutes of End Mills		4 Flutes Radius End mills (Center Cut)	
	h7	Tolerance of Drills Diameter is h7			2 Flutes Ball Nose End mills (Center Cut)	
	h8	Tolerance of Drills Diameter is h8			4 Flutes Ball Nose End mills (Center Cut)	
Flutes of End Mills		Sharp corner Type End mills	Type of Taps		6 Flutes Ball Nose End mills (Center Cut)	
		2 Flutes Square End mills (Center Cut)			Cutting Taps	
		3 Flutes Square End mills (Center Cut)		Forming Taps		
		4 Flutes Square End mills (Center Cut)	Flutes of Taps		Straight Flutes Taps	
		4 Flutes Square for X's-mill Hard (Center Cut)			Spiral Pointed Taps	
		5 Flutes Square End mills (Center Cut)			Normal Helix Flutes Taps	
		6 Flutes Square End mills (Center Cut)			High Helix Flutes Taps	
		6 Flutes Square for X's-mill Hard & X's-mill Multi Flutes (Center Cut)			Low Helix Flutes Taps	
		8 Flutes Square for X's-mill Hard & X's-mill Multi Flutes (Center Cut)		Chamfer of Taps		Chamfer Length is 2.5P to 3P
		4 Flutes Square End mills (with Center Hole)				Chamfer Length is 4P to 5P (for through hole)
		5 Flutes Square End mills (with Center Hole)			Chamfer Length is 1.5P (for blind hole)	
		6 Flutes Square End mills (with Center Hole)			Chamfer Length is 2.5P	
		Multiple Flutes (over 8) Square End mills (with Center Hole)			Chamfer Length is 3.5P	
		2 Flutes Radius End mills (Center Cut)			Cutting Taps for Taper Pipe	

Technical Data

DRILLS

DRILLS Cutting Condition

END MILLS

END MILLS Cutting Condition

TAPS

TAPS Cutting Condition

Others

HIGH PERFORMANCE DRILLS

List 7572P STUB LENGTH SG-ESS / METRIC SIZES



Specs/Sizes
Speeds/Feeds

P48
P100

List 7573P STUB LENGTH SG-ESS / FRACTIONAL, WIRE, LETTER



P52
P100

List 7570P JOBBERS LENGTH SG-ES / METRIC SIZES



P53
P100

List 7571P JOBBERS LENGTH SG-ES / FRACTIONAL, WIRE, LETTER



P54
P100

List 7596P Metric Sizes

SG DRILLS WITH OIL-HOLE

List 7591P Fractional



P55
P101

List 6517U UG POWER DRILLS / FRACTIONAL SIZES



P56
P101

List 6528P UG POWER DRILLS / METRIC SIZES



P57
P101

List 6596P AG-SUS DRILLS SHORT / METRIC SIZES



P58
P102

List 6594P AG-SUS DRILLS REGULAR / METRIC SIZES



P59
P102

List 6595P AG-SUS DRILLS REGULAR / FRACTIONAL SIZES



P60
P102

List 6540P Metric Sizes

AG-POWER LONG DRILLS

List 6541P Fractional



P61
P102

Technical Data

DRILLS

DRILLS Cutting Condition





END MILLS

END MILLS Cutting Condition

TAPS

TAPS Cutting Condition

Others

List 9550		AQUA DRILLS STUB / METRIC SIZES		Specs/Sizes Speeds/Feeds
h7	    		P63 P103	Technical Data
List 9551		AQUA DRILLS STUB / FRACTIONAL		
h7	    		P64 P103	DRILLS
List 9552		AQUA DRILLS REGULAR / METRIC SIZES		
h7	    		P65 P104	
List 9558		AQUA DRILLS WITH MIST-HOLE 3D		DRILLS Cutting Condition
h7	     		P66 P106	
List 9554		AQUA DRILLS WITH MIST-HOLE 5D		END MILLS Cutting Condition
h7	     		P67 P106	
List 9556		Metric Sizes		AQUA DRILLS WITH MIST-HOLE 7D
List 9569		Fractional		
h7	     		P68 P107	END MILLS Cutting Condition
List 9546		AQUA DRILLS THREE FLUTES / METRIC SIZES		
3FLUTE	js6     		P69 P104	END MILLS Cutting Condition
List 9548		AQUA DRILLS HARD / METRIC SIZES		
h7	    		P70 P105	TAPS
List 9544		AQUA MICRO DRILLS / METRIC SIZES		
    		P71 P105	TAPS Cutting Condition	
List 9588		Metric Sizes		
List 9589		Fractional		NEW
h7	   		P72 P108	TAPS Cutting Condition
List 9586		Metric Sizes		
List 9587		Fractional		NEW
h7	   		P74 P108	Others
List 9566		MQL PILOT DRILLS		
h7	   		P76 P110	

Technical Data

List 9564 10D **MQL POWER LONG DRILLS** **NEW** Specs/Sizes
Speeds/Feeds

List 9536 15D, 20D, 25D

h7



P77
P109

DRILLS

List 9501D **DIAMOND COATED CARBIDE DRILLS**



P78
P107

List 544 **DLC-HSS DRILLS / METRIC SIZES**

h7 >1.4



P79
P111

DRILLS
Cutting Condition

List 9524 **DLC MICRODRILLS / METRIC SIZES**

h7



P80
P111

List 9520 **DLC DRILLS REGULAR / METRIC SIZES**

h7



P81
P111

END MILLS

STRAIGHT SHANK DRILLS

END MILLS
Cutting Condition

List 500 **STRAIGHT SHANK JOBBERS LENGTH DRILL / METRIC SIZES** Specs/Sizes
Speeds/Feeds

h8 >0.55 >13.0



P82
P112

List 6520 **STRAIGHT SHANK COBALT DRILL TYPE I / METRIC SIZES**

h8 >1.5



P83
P112

TAPS

List 520P **G STANDARD DRILLS / METRIC SIZES**

h8 >3



P84
P112

TAPS
Cutting Condition

STRAIGHT SHANK JOBBERS LENGTH DRILL / LETTER SIZES

List 501 General Purpose

h8



P86
P112

List 501A General Purpose

h8



P86
P112

Others

List 6501 Aircraft NAS907-J

h8



P86
P112

STRAIGHT SHANK JOBBERS LENGTH DRILLS / FRACTIONAL

Specs/Sizes
Speeds/Feeds

		Technical Data
List 501	General Purpose	
h8		P86 P112
List 501A	General Purpose	
h8		P86 P112
List 6501	Aircraft NAS907-J	
h8		P86 P112
List 501P	General Purpose	
h8		P86 P112
List 517P	Parabolic	
h8		P86 P113

STRAIGHT SHANK JOBBERS LENGTH DRILLS / WIRE GAUGE SIZES

		DRILLS Cutting Condition
List 501	General Purpose	
h8		P86 P112
List 501A	General Purpose	
h8		P86 P112
List 6501	Aircraft NAS907-J	
h8		P86 P112
List 501P	General Purpose	
h8		P86 P112
List 517P	Parabolic	
h8		P86 P113

SCREW MACHINE LENGTH / FRACTIONAL SIZES

		END MILLS Cutting Condition
List 561	General Purpose	
h8		P88 P112
List 561P	General Purpose	
h8		P88 P112

Technical Data

DRILLS

DRILLS Cutting Condition

END MILLS

END MILLS Cutting Condition

TAPS

TAPS Cutting Condition

Others

Specs/Sizes
Speeds/Feeds

Technical
Data

SCREW MACHINE LENGTH / FRACTIONAL SIZES

List 563 Aircraft NAS907-C



P88
P112

List 6563 Aircraft NAS907-C



P88
P112

DRILLS

SCREW MACHINE LENGTH / WIRE GAUGE SIZES

List 561 General Purpose



P88
P112

List 561P General Purpose



P88
P112

DRILLS
Cutting Condition

List 563 Aircraft NAS907-C



P88
P112

List 6563 Aircraft NAS907-C



P88
P112

END MILLS

SCREW MACHINE LENGTH / LETTER SIZES

List 561 General Purpose



P88
P112

List 563 Aircraft NAS907-C



P88
P112

END MILLS
Cutting Condition

TAPS

List 6563 Aircraft NAS907-C



P88
P112

STRAIGHT SHANK TAPER LENGTH / FRACTIONAL SIZES

List 531 General Purpose



P90
P112

List 6531 General Purpose



P90
P112

TAPS
Cutting Condition

List 545P Parabolic Style



P90
P113

Others

STRAIGHT SHANK DRILL-EXTRA LENGTH

Specs/Sizes
Speeds/Feeds

List 551



P92
P113

List 6551 Parabolic Tang Drive



P92
P113

List 581 OIL HOLE DRILLS / STRAIGHT SHANK



P93
P114

TAPER SHANK DRILLS

List 601 TAPER SHANK DRILLS / REGULAR SHANKS / FRACTIONAL

Specs/Sizes
Speeds/Feeds



P94
P115

List 651 EXTRA LENGTH DRILLS / TAPER SHANK DRILLS



P95
P113

List 683 OIL HOLE DRILLS / TAPER SHANK



P96
P115

SPECIAL

List 575 SILVER AND DEMING DRILLS

Specs/Sizes
Speeds/Feeds



P97
P115

List 599 DRILL SETS / JOBBERS LENGTH

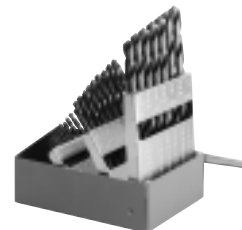

P98
P112

Technical
Data

DRILLS

DRILLS
Cutting Condition

END MILLS

END MILLS
Cutting Condition

TAPS

TAPS
Cutting Condition

Others

HIGH PERFORMANCE END MILLS

List 9382 GS-MILL TWO FLUTE

Specs/Sizes
Speeds/FeedsP142
P177

List 9384 GS-MILL FOUR FLUTE

P142
P177

List 9386 GS-MILL BALL

P143
P178

List 9408 MOLD MEISTER BALL

P143
P184

List 9398 GS-MILL HARD

P144
P179

List 9422 GS-MILL HARD BALL

P144
P181

List 9399 GEO-MILL HARD / INCH SIZES



NEW

P145
P180

List 9423 GEO-MILL HARD BALL / INCH SIZES



NEW

P145
P181

List 9322 X'S-MILL GEO / METRIC SIZES

P146
P182

List 9321 X'S-MILL GEO / INCH SIZES

P147
P182

List 9324 X'S-MILL GEO RADIUS

P148
P182

List 9338 X'S-MILL GEO SLOT

P149
P183Technical
Data

DRILLS

DRILLS
Cutting
Condition

END MILLS













END MILLS
Cutting
Condition

TAPS

TAPS
Cutting
Condition

Others

Endmills / Visual Index

		Specs/Sizes Speeds/Feeds		Technical Data
List 9366	X'S-MILL GEO KV TWO FLUTES			P150 P186
X's	Carbide	HELIX	Sharp Corner	
List 9368	X'S-MILL GEO KV FOUR FLUTES			P150 P186
X's	Carbide	HELIX	Sharp Corner	
List 9340	X'S-MILL GEO BALL			P151 P184
X's	Carbide	HELIX		
List 9332	X'S-MILL GEO MICROBALL			P152 P185
X's	Carbide	HELIX		
List 9330	DLC-MILL FOR ALUMINUM / METRIC SIZES			P153 P187
DLC	Carbide	HELIX		
List 9378	DLC-MILL SHARP CORNER TWO FLUTE			P153 P187
DLC	Carbide	HELIX	Sharp Corner	
List 9302	DLC-MILL RADIUS			P154 P187
DLC	Carbide	HELIX		
List 9390	DLC-MILL SLOT LONG SHANK			P155 P187
DLC	Carbide	HELIX		
List 9360	DLC-MILL BALL			P156 P190
DLC	Carbide	HELIX		
List 6450	DLC-HSS MILL / METRIC SIZES			P157 P191
DLC	HSS Co	HELIX		
List 6231HD	DLC-HSS MILL / INCH SIZES			P157 P191
DLC	HSS Co	HELIX		
List 6485	AG-MILL ROUGHING / INCH SIZES			P158 P192
AG	HSS Co	HELIX		
List 6403	AG-MILL HEAVY / INCH SIZES			P158 P193
AG	HSS Co	HELIX		

Technical
Data

DRILLS

DRILLS
Cutting Condition

END MILLS

END MILLS
Cutting Condition

TAPS

TAPS
Cutting Condition

Others

Technical Data

List 6406 AG-MILL ROUGHING SHORT

Specs/Sizes
Speeds/Feeds



P159
P192

DRILLS

List 6484 AG-MILL ROUGHING REGULAR LENGTH SHORT



P159
P192

DRILLS
Cutting Condition

List 6486 AG-MILL ROUGHING MEDIUM



P160
P192

List 6488 AG-MILL ROUGHING LONG



P160
P192

List 6402 AG-MILL HEAVY



P161
P193

END MILLS

List 6404 AG-MILL HEAVY LONG



P162
P193

END MILLS

END MILLS
Cutting Condition

GENAC END MILLS "SG" COATED CARBIDE

Specs/Sizes
Speeds/Feeds

List 9261X Regular



P163
P194

TAPS

List 9271X Ball Nose



P163
P195

TAPS
Cutting Condition

List 9263X Regular



P163
P194

List 9273X Ball Nose



P163
P195

List 9221X



Discontinued items



P164
P196

Others

List 9251X



P164
P196

GENAC END MILLS "SG" COATED CARBIDE LONG SERIES

Specs/Sizes
Speeds/Feeds

List 9265X



Discontinued items



P165
P194

List 9267X



P165
P194

List 9275X



Discontinued items



P165
P195

List 9277X



Discontinued items



P165
P195

ROUGHING AND FINISHING (HEAVY DUTY) END MILLS

List 6367



P166
P203

List 6367X



P166
P199

ROUGHING (HOG) END MILLS

List 6303



P167
P203

List 6303X



P167
P199

List 6307



P168
P203

TWO FLUTE END MILLS / REGULAR-SINGLE END

List 231



Discontinued items



P169
P200

List 6231



P169
P200

Technical
Data

DRILLS

DRILLS
Cutting Condition

END MILLS

END MILLS
Cutting Condition

TAPS

TAPS
Cutting Condition

Others

Specs/Sizes
Speeds/Feeds

Technical
Data

TWO FLUTE END MILLS / REGULAR-SINGLE END

List 6231X



P169
P197

DRILLS

List 6233 TWO FLUTE END MILLS / LONG, SINGLE END



P170
P200

DRILLS
Cutting Condition

TWO FLUTE DOUBLE END MILLS

List 261



Discontinued items



P171
P200

METRIC SIZES, REGULAR, SINGLE END

List 6230



P172
P200

END MILLS

List 6210



P172
P201

END MILLS
Cutting Condition

MULTI FLUTE END MILLS / REGULAR SINGLE END CENTER CUTTING

List 211



Discontinued items



P173
P201

List 6211M



P173
P201

TAPS

List 6211X



P173
P198

TAPS
Cutting Condition

MULTI FLUTE END MILLS / LONG SINGLE END, CENTER CUTTING

List 213



Discontinued items



P174
P201

List 6213



P174
P201

Others

Endmills / Visual Index

List 215 **FOUR FLUTE END MILLS / EXTRA LONG SINGLE END, CENTER CUTTING**

Specs/Sizes
Speeds/Feeds



Discontinued items



P175
P201

FOUR FLUTE, DOUBLE END END MILLS

List 271



Discontinued items



P176
P201

Technical
Data

DRILLS

DRILLS
Cutting Condition

END MILLS

END MILLS
Cutting Condition

TAPS

TAPS
Cutting Condition

Others

Technical Data
 DRILLS
 DRILLS Cutting Condition
 END MILLS
 END MILLS Cutting Condition
 TAPS
 TAPS Cutting Condition
 Others

HIGH PERFORMANCE TAPS

List 6955 **DLC TAFLET THREAD FORMING TAPS / FRACTIONAL SIZE** Specs/Sizes
Speeds/Feeds



P228
P260

List 6957 **DLC TAFLET THREAD FORMING TAPS / MACHINE SCREW SIZES**



P228
P260

List 6956 **DLC TAFLET THREAD FORMING TAPS / METRIC SIZES**



P229
P260

List 6959 **SG LO-SPIRAL FLUTED TAPS / MACHINE SCREW SIZES & FRACTIONAL SIZE**



P230
P260

List 6958 **SG LO-SPIRAL FLUTED TAPS / METRIC SIZES**



P231
P260

VIPER T-SERIES

List 7981 **VIPER T SERIES-SPIRAL FLUTED / GENERAL PURPOSE** Specs/Sizes
Speeds/Feeds



P233
P260

List 7971 **VIPER T SERIES-SPIRAL POINTED / GENERAL PURPOSE**



P234
P260

VIPER T SERIES-METRIC TAPS / GENERAL PURPOSE

List 7980 Spiral Fluted



P235
P260

List 7970 Spiral Pointed



P235
P260

List 7987 **VIPER T SERIES-SPIRAL FLUTED / FOR STAINLESS STEEL**



P236
P260

List 7977 VIPER T SERIES-SPIRAL POINTED / FOR STAINLESS STEEL

Specs/Sizes
Speeds/Feeds



P237
P260

VIPER T SERIES METRIC TAPS / FOR STAINLESS STEEL

List 7982 Spiral Fluted



P238
P260

List 7972 Spiral Pointed



P238
P260

VIPER TAFLET

VIPER TAFLET FOR STEELS

Specs/Sizes
Speeds/Feeds

List 995 Machine Screw Sizes



P240
P260

List 995 Fractional Sizes



P241
P260

List 996 VIPER TAFLET METRIC TAPS FOR STEELS



P242
P260

VTP TAPS

VTP SPIRAL FLUTED

Specs/Sizes
Speeds/Feeds

List 983 Machine Screw Sizes



P244
P260

List 981 Fractional Sizes



P244
P260

Technical
Data

DRILLS

DRILLS
Cutting Condition

END MILLS

END MILLS
Cutting Condition

TAPS

TAPS
Cutting Condition

Others

Technical Data

VTP SPIRAL POINTED

Specs/Sizes
Speeds/Feeds

List 973 Machine Screw Sizes



P245
P260

List 971 Fractional Sizes



P245
P260

DRILLS

VTP ROLL FORM TAPS

List 993 Machine Screw Sizes



Discontinued items



P246
P260

List 991 Fractional Sizes



Discontinued items



P247
P260

DRILLS
Cutting Condition

List 980 VTP METRIC TAPS SPIRAL FLUTED



P249
P260

END MILLS

List 982 VTP METRIC TAPS SPIRAL POINTED



P249
P260

END MILLS
Cutting Condition

STANDARD TAPS

STANDARD HAND TAPS

Specs/Sizes
Speeds/Feeds

List 911 Fractional Sizes



P250
P260

List 911P Fractional Sizes



P250
P260

List 913 Machine Screw Size



P251
P260

List 913P Machine Screw Sizes



P251
P260

TAPS

TAPS
Cutting Condition

Others

STANDARD TAPS SPIRAL POINTED / FRACTIONAL SIZES

Specs/Sizes
Speeds/Feeds

List 921 Fractional Sizes



P252
P260

List 921S Fractional Sizes



P252
P260

List 921P Fractional Sizes



P252
P260

List 969 STANDARD HAND TAPS / FOR CAST IRON



P252
P260

STANDARD TAPS SPIRAL POINTED / MACHINE SCREW SIZES

List 923 Machine Screw Sizes



P253
P260

List 923S Machine Screw Sizes



P253
P260

List 923P Machine Screw Sizes



P253
P260

STANDARD TAPS / SPIRAL FLUTED

List 931 Fractional Sizes



Discontinued items



P254
P260

List 933 Machine Screw Sizes



Discontinued items



P254
P260

STANDARD TAPS / FAST SPIRAL FLUTED

List 931H Fractional Sizes



Discontinued items



P255
P260

List 933H Machine Screw Sizes



Discontinued items



P255
P260

Technical Data
DRILLS
DRILLS Cutting Condition
END MILLS
END MILLS Cutting Condition
TAPS
TAPS Cutting Condition
Others

Specs/Sizes
Speeds/Feeds

Technical
Data

STANDARD TAPS / .005 OVERSIZED

List 915 Fractional Sizes & Machine Screw Sizes



Discontinued items



P256
P260

DRILLS

List 925 Fractional & Machine Screw Sizes



P256
P260

DRILLS
Cutting Condition

TAPER PIPE TAPS / STRAIGHT FLUTED

List 941 (NPT)



P257
P260

List 941P (NPT)



P257
P260

END MILLS

TAPER PIPE TAPS / STRAIGHT FLUTED

List 941D (NPTF)



P257
P260

END MILLS
Cutting Condition

TAPER PIPE TAPS / INTERRUPTED



P257
P260

TAPS

TAPER PIPE TAPS / SPIRAL FLUTED

List 947 (NPT)



P258
P260

List 947D (NPTF)



P258
P260

TAPS
Cutting Condition

STRAIGHT PIPE TAPS / STRAIGHT FLUTED

List 945 (NPS)



P258
P260

List 945D (NPSF)



P258
P260

Others

List 910 STANDARD METRIC HAND TAPS

Specs/Sizes
Speeds/Feeds



P259
P260

List 920 STANDARD METRIC TAPS / SPIRAL POINTED



P259
P260

Technical
Data

DRILLS

DRILLS
Cutting Condition

END MILLS

END MILLS
Cutting Condition

TAPS

TAPS
Cutting Condition

Others



DRILLS

Technical Data

DRILLS

DRILLS Cutting Condition

END MILLS

END MILLS Cutting Condition

TAPS

TAPS Cutting Condition

Others

Features

- Utilizes a high accuracy shape of lip relief (3 rake, 2 rake + x-thinning)
- Made from premium powder metal with Composite Multi-Layer SG Coating (TiCN)
- End mill style shanks for highly precise and accurate drilling

Work Materials

Structural Steels, Carbon Steels, Alloy Steels, Stainless Steels, Cast Irons, Aluminum Alloys

Performance

- Streamline the process and reduce machining time dramatically.
- Eliminate the center drill operation with our SG-ESS drills (Stub length)
- Stable positioning within 0.0006" (15µm)
- Faster feed & speed rates than regular HSS-Co drills
- Better cost performance than carbide drills



SG-ESS Drills (stub length)
Self centering point:



SG-ES Drill
(jobber's length):

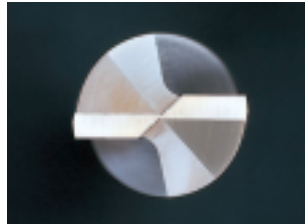

Positioning

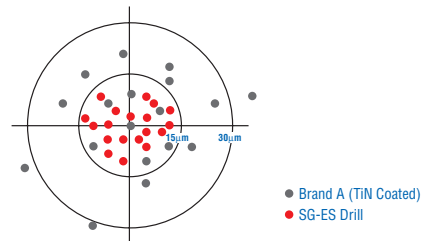

Performance and cutting data of SG drill series

Characteristics of SG coating

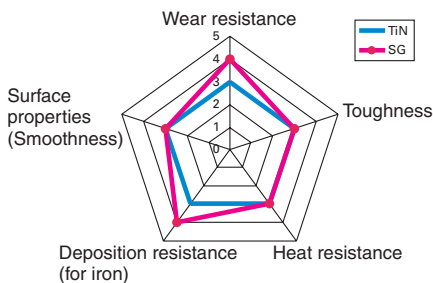

Composite multi-layer film coating method characterized by improved wear resistance as compared to TiN.

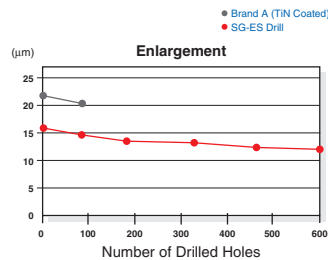

Cutting condition

Drill Dia : 9.0mm.
Hole Depth : 32mm
Cutting Speed : 20m/min. (65.6 SFM)
Feed : 142mm/min (5.6 IPM)
Work piece Material : Alloy steel (300HB)
Machine : Vertical machining center

Stocked Size	Drill Name	List No.	Page
	SG-ESS Drill/Metric Sizes	7572P	48
	SG-ESS Drill/Fractional Sizes	7573P	52
	SG-ESS Drill/Wire & Letter Sizes	7573P	52
	SG-ES Drill/Metric Sizes	7570P	53
	SG-ES Drill/Fractional Sizes	7571P	54
	SG-ES Drill/Wire & Letter Sizes	7571P	54
	SG-OH Drill/Fractional Sizes	7591P	55
	SG-OH Drill/Metric Sizes	7596P	55

Features

- Utilizes a high accuracy shape of lip relief (3 rake thinning)
- Made from New HSS (FM-HSS: Fine melting HSS) with Composite Multi-Layer AG Coating (TiAlN)

	Conventional HSS	Powder Metal HSS	FM-HSS
Micro Structure			
Toughness	○	○	●
Heat Resistance	○	●	●
Wear Resistance	○	●	●

○ GOOD ● EXCELLENT

- End mill style shanks for highly precise and accurate drilling

Work Materials

Austenitic Stainless Steels, Martensitic Stainless Steels, Ferritic Stainless Steels, Structural Steels, Low Carbon Steels



Performance

CUTTING CONDITION

Drill Dia.: 6mm
 Material: S42020 (SUS420J2)
 Hole Depth: 20mm through
 Speed: 78 SFM (1.275 rpm)
 Feed: 190mm/min (7.48 IPM)
 Pecking: Non
 Coolant: Emulsion

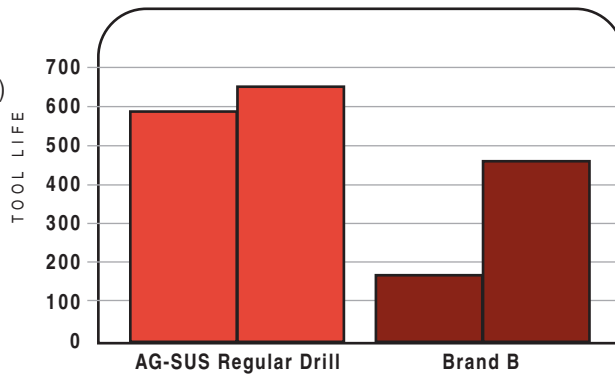

CHIP SHAPE-
 NACHI AG-SUS DRILL VS. COMPETITOR
 FOR STAINLESS STEEL

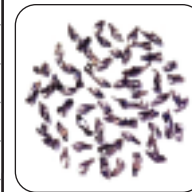

AG-SUS DRILL



COMPETITOR

CUTTING CONDITION

Drill Dia.: 1mm (0.039")
 Material: S304 (175 HB)
 Hole Depth: 5mm blind
 Speed: 49 SFM (4.775 rpm)
 Feed: 100mm/min (3.94 IPM)
 Pecking: 1mm
 Coolant: Emulsion

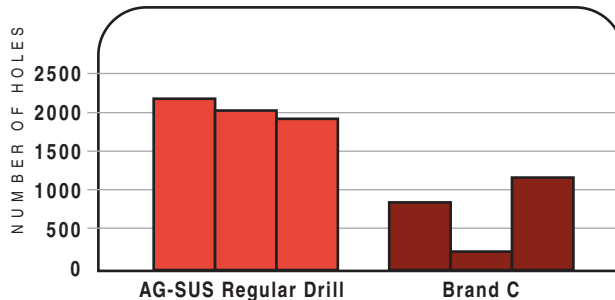

Stocked Size	Drill Name	List No.	Page
	AG-SUS Drill Short/Metric Sizes	6596P	58
	AG-SUS Drill Regular/Metric Sizes	6594P	59
	AG-SUS Drill Regular/Fractional Sizes	6595P	60

Technical Data

DRILLS

DRILLS Cutting Condition

END MILLS

END MILLS Cutting Condition

TAPS

TAPS Cutting Condition

Others

Technical
Data

Features

New style Parabolic Drills

The Nachi UG-Power drill is designed for deep hole drilling. Flute geometry allows for easy chip removal and enable non pecking drilling up to 7X diameter.

Work Materials

APPLICABLE MATERIAL

- Carbon Steel
- Alloy Steel
- Tool Steel
- Die Steel
- Cast Iron
- Stabilized Steel (under 35HRC)

UNSUITABLE MATERIAL

- Soft Steel
- Aluminum
- Copper Alloy
- Hardened Steel (over 40HRC)



DRILLS

DRILLS
Cutting Condition

Performance

**TOOL LIFE-
NACHI UG DRILL VS. OTHER PARABOLIC BRAND DRILLS**

CONDITION

Drill Dia. : 1/4"
Material : AISI 1049
Hole Depth : 1-3/4" (7D)
Speed : 105'/min (1800 RPM)
Feed : 12.4"/min (.007"/rev)
Without pecking

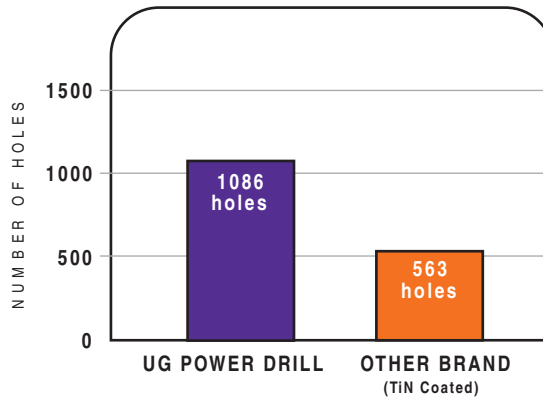

END MILLS

END MILLS
Cutting Condition



UG Power Drills



Competitor

Tool life is 1.5 times longer than competitor

UG Power Drills

Competitor

Cutting condition
Drill : 6mm (0.236in)
Speed : 33m/min (108 SFM)
Feed : 0.18mm/rev (12.4 IPM)
Depth : 48mm (1.9in) blind hole
Material : C45 (180HB) / S45C / 1045
Fluid : Emulsion

TAPS

TAPS
Cutting Condition

Others

Stocked Size	Drill Name	List No.	Page
*	UG-POWER Drill/Fractional Sizes	6517U	56
*	UG-POWER Drill/Metric Sizes	6528P	57

* JAPAN STOCK ITEM : Please allow 2-3 weeks delivery.

Features

New style Parabolic Drills

- Flute geometry and coating enables non pecking deep hole drilling up to 20XD.
- AG Coating (TiAlN) and HSS-Co material increases tool life.

Work Materials

Carbon Steels, Alloy Steels, Mold Steels,
Hardened Steels (under 40HRC), Cast Irons

Performance

AG POWER LONG DRILL VS. STANDARD DRILL



Stable torque

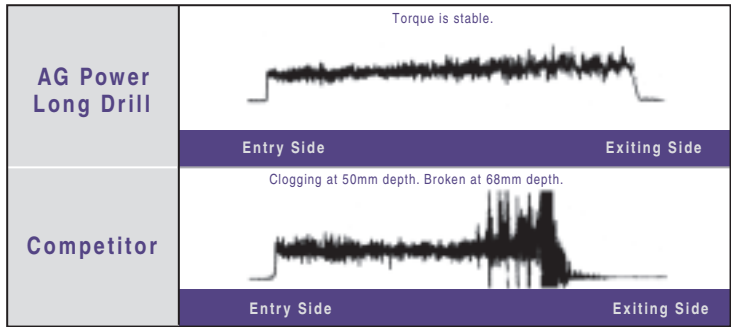

CUTTING CONDITION

Drill : 6mm (0.236in)
Material : 1050 (217HB) S50C
Hole Depth : 102mm (4.01in : 17D) through
Speed : 1590rpm (98 SFM)
Feed : 0.1mm/rev (6.26 IPM)
non-pecking drilling
Fluid : Emulsion

Long tool life

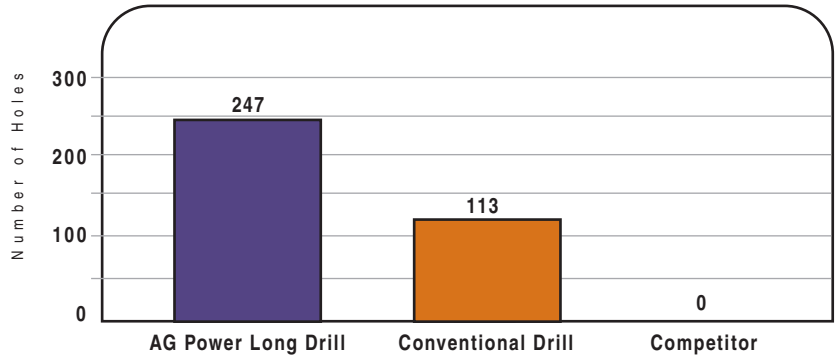

Stocked Size	Drill Name	List No.	Page
*	AG Power Long Drill/Metric Sizes	6540P	61
	AG Power Long Drill/Fractional Sizes	6541P	61

* JAPAN STOCK ITEM : Please allow 2-3 weeks delivery.

Technical
Data

DRILLS

DRILLS
Cutting Condition

END MILLS

END MILLS
Cutting Condition

TAPS

TAPS
Cutting Condition

Others

Technical Data

DRILLS

DRILLS Cutting Condition

END MILLS

END MILLS Cutting Condition

TAPS

TAPS Cutting Condition

Others

Features

- Aqua coating has a self-lubricant and offers superior heat resistance. (Composite and multi-layered TiAIN + original lubricant film)
- Tough micro grain carbide enables a longer tool life.
- End mill type shank (List 9550, 9551, 9552, 9546, 9548, 9544)
- Cylindrical type shank (List 9556, 9569)
- Negative corner edge design prevents chipping.

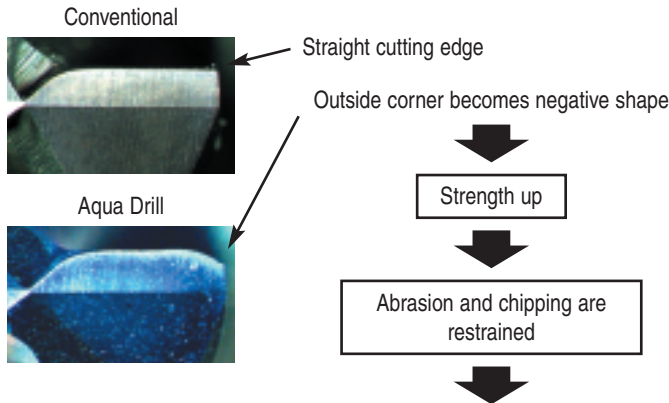

It is suitable for dry cutting and high speed cutting with fluid

Wide range of Cutting condition

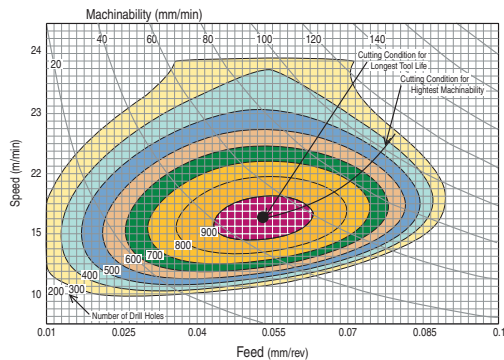

AQUA Drills Hard

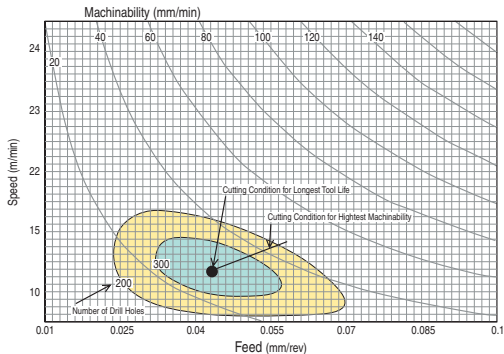

Competitor

AQUA Drills 3flutes

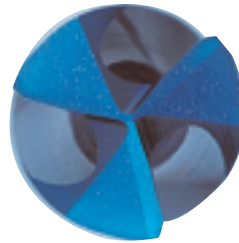

AQUA Drills Stub

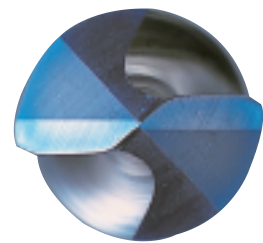

Stocked Size	Drill Name	List No.	Page
*	AQUA Drill Stub/Metric Sizes	9550	63
*	AQUA Drill Stub/Fractional Sizes	9551	64
*	AQUA Drill Regular/Metric Sizes	9552	65
*	AQUA Drill with Mist Hole 3D	9558	66
*	AQUA Drill with Mist Hole 5D	9554	67
*	AQUA Drill with Mist Hole 7D/Metric Sizes	9556	68
*	AQUA Drill with Mist Hole 7D/Fractional Sizes	9569	68
*	AQUA Drill 3 Flute/Metric Sizes	9546	69
*	AQUA Drill Hard/Metric Sizes	9548	70
*	AQUA Drill Micro/Metric Sizes	9544	71

* JAPAN STOCK ITEM : Please allow 2-3 weeks delivery.

Work Materials

- Structural Steel
- Carbon Steel
- Alloy Steel
- Pre-Hardened Steel
- Cast Iron
- Stainless Steel (*AQUA Micro Drill)
- Die Steel
- Annealed Steel (30 - 40HRC)
- Hardened Steel (40 - 50HRC)
- * AQUA Drill Hard.
- Hardened Steel (50 - 70HRC)

Performance

Excellent for accurate drilling

- Has accurate point geometry for high rigidity
- Superior positioning within 0.01mm (0.0004") without center drill

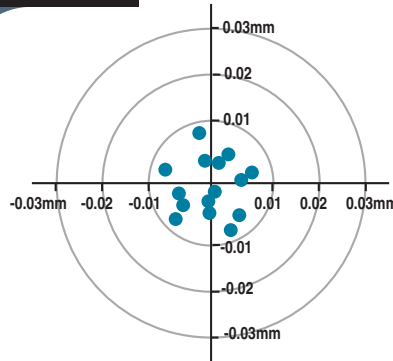

Drill Dia. : 1/4"
 Material : S50C (1050), 185 HB
 Hole Depth : 18mm through
 Speed : 108m/min (5000 RPM)
 Feed : 0.16mm/rev (800mm/min)
 Coolant : Water base coolant

HIGH SPEED DRY DRILLING—THE NACHI AQUA DRILL VS. OTHER BRANDS

CONDITION

Drill : 6mm (0.2362")
 Material : Alloy steel
 (Hardness : 310 HB)
 Hole Depth : 18mm blind
 Speed : 60m/min (196 SFM)
 Revolution : 3183 RPM
 Feed : 477mm/min (18.7 IPM)
 Dry (Air blow)

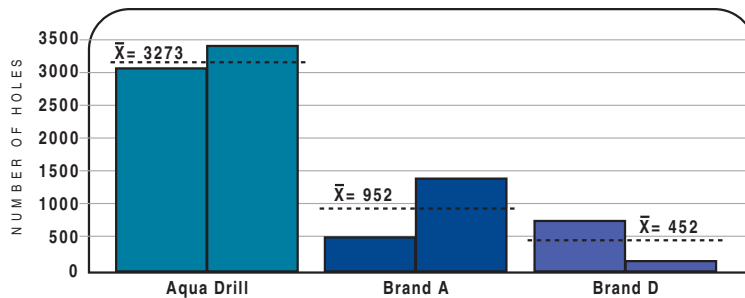

CHIP SHAPE

The Aqua Drill produces chips which will dissipate heat quickly.



HIGH SPEED WET DRILLING—THE NACHI AQUA DRILL VS. OTHER BRANDS

CONDITION

Drill : 6mm (0.2362")
 Material : Alloy steel
 (Hardness : 310 HB)
 Hole Depth : 21mm through
 Speed : 100m/min (328 SFM)
 Revolution : 5305 RPM
 Feed : 1061mm/min (41.7 IPM)
 Water Soluble

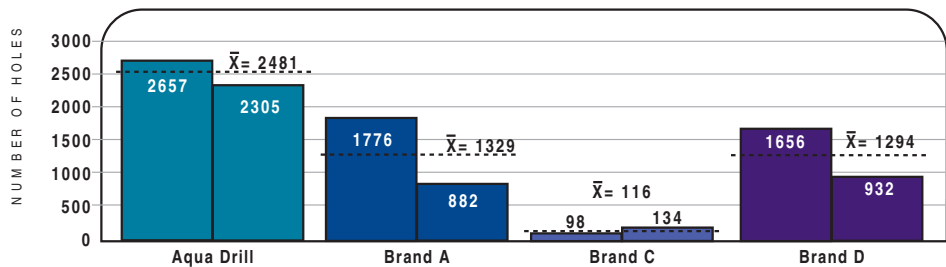

Roundness is under 3µm in pre-hardened steels

Drilling condition

Drill : 10mm
 Speed : 80m/min (2,550min⁻¹)
 Feed : 0.27mm/rev (680mm/min)
 Hole Depth : 30mm (Blind)
 Material : NAK80 (40HRC) / Die Steel
 Coolant : Emulsion

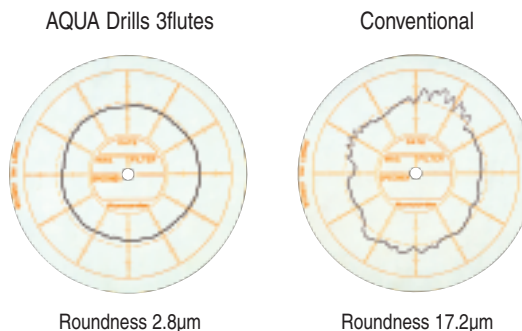

Technical Data

DRILLS

DRILLS Cutting Condition

END MILLS

END MILLS Cutting Condition

TAPS

TAPS Cutting Condition

Others

Technical Data

DRILLS

DRILLS Cutting Condition

END MILLS

END MILLS Cutting Condition

TAPS

TAPS Cutting Condition

Others

Features

- Utilize high accuracy shape of relief (2rake +XWthinning)
- Coolant Through Solid Carbide Drill
- "S" shaped cutting edge for superior chip removal
- Made from High grade carbide with Composite Multi-layer GS Coating (Al-Ti-Cr based coating)



Selection Chart

● :Great ○ :Good △ :OK

Workpiece Material																
Carbon Steel		Alloy Steel	Die Steel	Hardened Steel			Stainless Steel		Titanium Alloys	Nickel Alloys	Cast Iron		Aluminum			Copper Alloys
Low Carbon	High Carbon			HRC			Austenitic	Martensitic			Soft	Hard	6061	Casting	High Si	
1010,1018	1045,1065	4140,4330	D2	up to 35	35 to 45	45 to 65	300 Series	400 Series			<200HB	>200HB	7075	Si≤12%	Si>13%	
●	●	●	●	○			●	●	●	●	○	△	○	○		○

DRILLING IN 304 STAINLESS

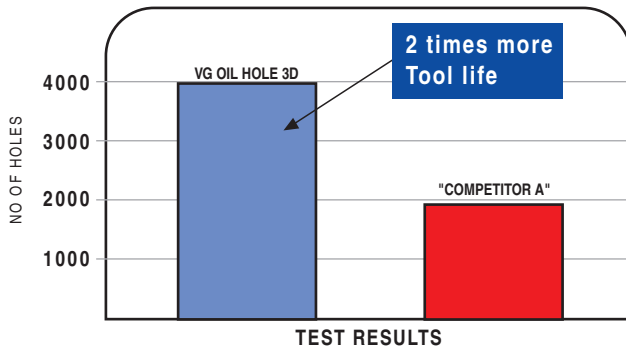

CUTTING CONDITIONS

Drill: 8.0mm
 Speed: 132SFM,40.2m/min
 RPM: 1600
 Feed: 16IPM (.010 IPR)
 400mm/min (0.01mm/rev)
 Hole: 23mm Blind
 Work Material: 304 Stainless Steel
 Coolant: Water Soluble

Features

- "S" shaped cutting edge for superior chip removal
- Made from High grade carbide with Composite Multi-layer GS Coating (Al-Ti-Cr based coating)
- Utilizes high accuracy shape of relief (2 rake + XW thinning)
- Double Margin for increased drilling stability and performance



"S" shaped cutting edge



Use of a double margin increases drilling straightness by controlling drill bending and swelling.

Cutting Performance

- Streamline the Process and reduce machining time dramatically.

Limit comparison at feed

Feed	IPR	.007	.011	.013	.015	.017	.019	.027	.023
	mm/rev	0.2	0.3	0.35	0.4	0.45	0.5	0.55	0.6
MQL Power Long Drill		○	○	○	○	○	○	○	○
Competitor		○	○	○	○	×			

Tool : 6×150×200×6
Cutting Speed : RPM = 4250
Feed : IPR = .007~.024
Hole Depth : 4.7"

Guide Hole Depth : 1"
Work Material : Carbon Steel
Cutting Fluid : MQL (3cc/h)

Drilling surface roughness and tool life in double margin

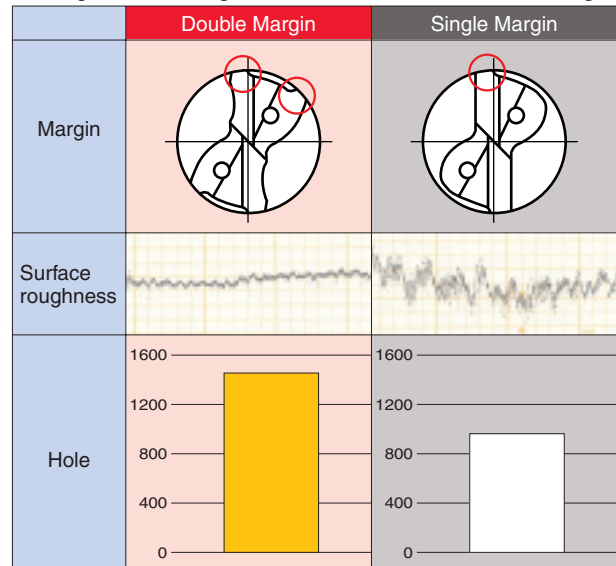

Tool : 5×130×180×5
Cutting Speed : RPM = 5100
Feed : IPR = .006 (0.15mm/rev)

Hole Depth : 4"
Work Material : Carbon Steel
Cutting Fluid : MQL

Non-step drilling improves machining efficiency by 5x.

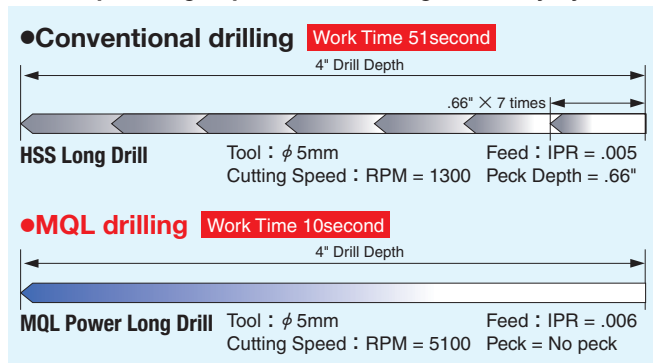

Work Materials

- Structural Steels, Carbon Steels, Alloy Steels, Stainless Steels, Cast Irons, Hardened Steel (up to 40HRC)

MQL Pilot Drills

Precision guide hole drills for MQL Long Drills

Features

- Coolant Thru Solid Carbide drills with "S" Shaped cutting edge for superior chip removal
- Precision Guide hole drills for our MQL Long Drills
- Made from high grade carbide with composite Multi-layer GS Coating (Al-Ti-Cr based coating)
- Utilizes high accuracy shape of relief (2rake + XW thinning)
- Double margin to provide accurate and straight guide hole for MQL Long Drills



"S" shaped cutting edge



Work Materials

Structural Steels, Carbon Steels, Alloy Steels, Stainless Steels, Cast Irons, Hardened Steels (up to 40Hrc)

Technical Data

DRILLS

DRILLS Cutting Condition

END MILLS

END MILLS Cutting Condition

TAPS

TAPS Cutting Condition

Others

Technical Data

DRILLS

DRILLS Cutting Condition

END MILLS

END MILLS Cutting Condition

TAPS

TAPS Cutting Condition

Others

Features

- Utilizes high accuracy shape of lip relief (2 rake thinning)
- Utilizes flute geometry resulting in excellent chip control and dry milling with no edge build-up
- End mill style shanks for highly precise and accurate drilling

Work Materials

Aluminums, Aluminum alloys, Aluminum Alloy Casting, Aluminum Alloy Die-casting, Copper alloys

Performance

WET DRILLING BY DLC DRILL

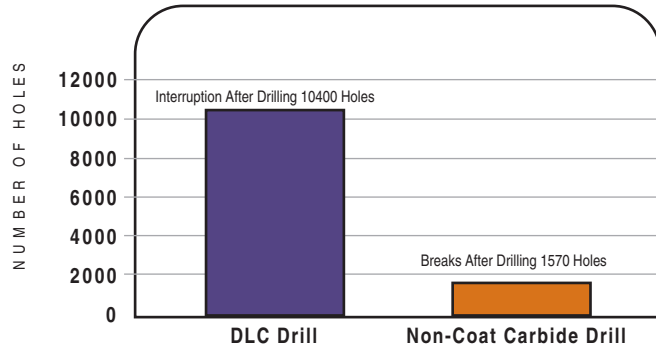

Small wear after drilling 10400 holes

DRY DRILLING BY DLC DRILL

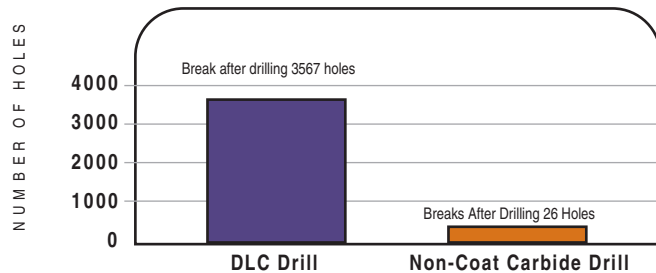

CONDITION

Drill: 5.5mm (0.2165")
 Material: AlMg2.5 (A5052)
 Hole Depth: 27.5mm (1.06") blind
 Speed: 100m/min (328 SFM)
 Feed: 0.08mm/rev (18.26 IPM)
 Coolant: Emulsion

CONDITION

Drill: 5.5mm (0.2165")
 Material: ADC12
 Hole Depth: 16.5mm (0.65") blind
 Speed: 100m/min (328 SFM)
 Feed: 0.08mm/rev (18.26 IPM)
 Coolant: Dry

Stocked Size	Drill Name	List No.	Page
	DLC HSS Drill/Metric Sizes	544	79
	DLC Micro Drill/Metric Sizes	9524	80
	DLC Drill Regular/Metric Sizes	9520	81

* JAPAN STOCK ITEM : Please allow 2-3 weeks delivery.

Drills / Selection Chart

HIGH PERFORMANCE DRILLS

Technical Data	Drill Name	Material	Coating		Stock Size	Stock USA ● Japan ○	LIST No		Image			
							Size	Cutting Condition				
										Page		
DRILLS	Metric NEW SIZE SG-ESS Drills	PM-HSS	SG	Metric	1.0 to 20.0	●	7572P	p.48 p.100				
				Fractional	3/32 to 3/4	●	7573P	p.52 p.100				
				Letter Wire	B to Z #1 to #45	●	7573P	p.52 p.100				
	SG-ES Drills			Metric	2.0 to 20.0	●	7570P	p.53 p.100				
				Fractional	3/32 to 3/4	●	7571P	p.54 p.100				
				Letter Wire	B to Z #1 to #45	●	7571P	p.54 p.100				
	SG-OH Drills			Metric	5.0 to 20.0	●	7596P	p.55 p.101				
				Fractional	15/64 to 3/4	●	7591P	p.55 p.101				
	UG-POWER Drills			HSS-Co	UG	Fractional	3/64 to 1/2	●	6517U	p.56 p.101		
Metric		1.0 to 13.0	○			6528P	p.57 p.101					
END MILLS	AG-SUS Drills Short	FMX	AG	Metric	1.0 to 20.0	●	6596P	p.58 p.102				
	Fractional			3/32 to 3/4	●	6595P	p.60 p.102					
	AG-SUS Drills Regular	Metric		1.0 to 20.0	●	6594P	p.59 p.102					
	AG-Power Long Drills	HSS-Co		Fractional	1/8 to 23/64	●	6541P	p.61 p.102				
END MILLS	AQUA Drills Stub		AQUA	Metric	1.0 to 13.0	○	6540P	p.61 p.102				
				Metric	3.0 to 20.0	○	9550	p.63 p.103				
TAPS	AQUA Drills Regular	Carbide	AQUA	Fractional	1/8 to 3/4	●	9551	p.64 p.103				
	AQUA Drills with Mist Hole 3D			Metric	2.0 to 20.0	○	9552	p.65 p.104				
	AQUA Drills with Mist Hole 5D			Metric	4.5 to 16.0	○	9558	p.66 p.106				
	AQUA Drills with Mist Hole 7D			Metric	4.5 to 16.0	○	9554	p.67 p.106				
	AQUA Drills 3Flute			Metric	5.0 to 16.0	○	9556	p.68 p.107				
	AQUA Drills Hard			Fractional	3/16 to 5/8	●	9569	p.68 p.107				
	AQUA Micro Drills			Metric	3.0 to 12.0	○	9546	p.69 p.104				
	VG OIL HOLE DRILLS 3D NEW			Metric	2.0 to 12.0	○	9548	p.70 p.105				
	VG OIL HOLE DRILLS 5D NEW			Metric	0.20 to 1.99	●	9544	p.71 p.105				
	MQL PILOT DRILLS NEW			Metric	3 to 12.7	●	9588	p.72 p.108				
	Others			MQL POWER LONG DRILLS NEW		GS	Fractional	1/8 to 1/2	●	9589	p.73 p.108	
							Metric	3 to 12.7	●	9586	p.74 p.108	
							Fractional	1/8 to 1/2	●	9587	p.75 p.108	
				Metric	—	●	9566	p.76 p.110				
				Metric Fractional	3.0 to 17.5	●	9564	p.77 p.109				
				Metric Fractional	15D,20D 4.0 to 10.0 25D 4.0 to 8.0	●	9536	p.77 p.109				

Continue to next page.

●:Great ○:Good △:OK

	Drilling Depth *1				Workpiece Material																
	≤3D	≤5D	≤7D	>7D	Carbon Steel		Alloy Steel	Die Steel	Hardened Steel			Stainless Steel		Titanium Alloys	Nickel Alloys	Cast Iron		Aluminum			Copper Alloys
					Low Carbon	High Carbon			HRC	Austenitic 300 Series	Martensitic 400 Series	Soft <200HB	Hard >200HB			6061 7075	Casting Si ≤12%	High Si >13%			
					1010,1018	1045,1065	4140,4330	D2						up to 35	35 to 45				45 to 65		
●				●	●	●	●	○			●	●	●	●	○	△	○	○			○
●				●	●	●	●	○			●	●	●	●	○	△	○	○			○
●	○			●	●	●	●	○			●	●	●	●	○	△	○	○			○
●	●	●		●	●	●	●	○				●			△		○	○			
●	●	●	○	●	●	●	●	○				●			△		○	○			
●	●			●	●	●	●	○			●	●	●	●	○		○	○			△
●	●			●	●	●	●	○			●	●	●	●	○		○	○			△
○	●	●		●	●	●	●	△							●	○					
○	●	●		●	●	●	●	△							●	○					
●				△	△	△	△				●	●	○	○							
○	●	●		△	△	△	△				●	●	○	○							
○	●	●		△	△	△	△				●	●	○	○							
	△	●	●		●	●	●	△							●	○					
	△	●	●		●	●	●	△							●	○					
●					●	●	●	●	○	△					○	△					
●					●	●	●	●	○	△					○	△					
●	●				●	●	●	●	○	△					○	△					
○	●	●			●	●	●	●	○	△					○	△					
○	●	●			●	●	●	●	○	△					○	△					
●					●	●	●	●	○	△					○	△					
●					●	●	●	●	○	△					○	△					
●	●	●	○		●	●	●	●	○	△		●	●	○	○	○	△				
●					●	●	●	●	○	△		●	●	●	●	○	△	○	○		○
●					●	●	●	●	○	△		●	●	●	●	○	△	○	○		○
●	●				●	●	●	●	○	△		●	●	●	●	○	△	○	○		○
●	●				●	●	●	●	○	△		●	●	●	●	○	△	○	○		○
●					●	●	●	●	○	△		●	●			○	○	○	○		
			△	●	●	●	●	●	○	△		●	●			○	○	○	○		
				●	●	●	●	●	○	△		●	●			○	○	○	○		

*Some sizes does not meet this preference. Please make sure of flute length of each sizes before use.

42 Drills / Selection Chart

Technical Data

DRILLS

DRILLS Cutting Condition

END MILLS



END MILLS Cutting Condition

TAPS

TAPS Cutting Condition

















Others

High performance drills (Continued)

Drill Name	Material	Coating		Stock Size	Stock USA ● Japan ○	LIST No		
						Page Size	Cutting Condition	
DIAMOND COATED Drills	Carbide	DIAMOND	Fractional	1/16 to 1/2	● *	9501D p.78 p.107		
DLC HSS Drills	HSS	DLC	Metric	1.0 to 13.0	○	544 p.79 p.111		
DLC Micro Drills	Carbide		Metric	0.5 to 1.9	○	9524 p.80 p.111		
DLC Drills Regular			Metric	2.0 to 12.0	○	9520 p.81 p.111		



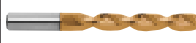















* : Special Order

STRAIGHT SHANK DRILLS

Drill Name		Material	Coating		Stock Size	Stock USA ● Japan ○	LIST No					
							Page Size	Cutting Condition				
Jobbers Length	Standard	HSS	Black Oxide	Metric	0.2 to 17.5	●	500 p.82 p.112					
				Fractional	3/64 to 11/16	●	501 p.86 p.112					
				Wire	#1 to #60	●	501 p.86 p.112					
				Letter	A to Z	●	501 p.86 p.112					
				Fractional	1/64 to 11/16	●	501A p.86 p.112					
				Wire	#1 to #80	●	501A p.86 p.112					
				Letter	A to Z	●	501A p.86 p.112					
				Fractional	1/16 to 1/2	●	501P p.86 p.112					
				Wire	#1 to #52	●	501P p.86 p.112					
				Metric	0.5 to 13.0	○	520P p.84 p.112					
				High Helix	HSS-Co	Black Oxide	Metric	0.5 to 13.0	○	6520 p.83 p.112		
				Aircraft NAS 907-B	HSS-Co	Black Oxide	Fractional	1/64 to 1/2	●	6501 p.86 p.112		
	Wire	#1 to #80	●				6501 p.86 p.112					
	Letter	A to Z	●				6501 p.86 p.112					
	Parabolic	HSS	TiN	Fractional	1/16 to 1/2	●	517P p.86 p.113					
				Wire	#1 to #52	●	517P p.86 p.113					

44 Drills / Selection Chart

STRAIGHT SHANK DRILLS

Drill Name	Material	Coating	Stock Size	Stock USA ● Japan ○	LIST No		Image	
					Page Size	Page Cutting Condition		
Screw Machine Length	HSS	Black Oxide	Fractional	3/64 to 2	●	561		
						p.88	p.112	
			Wire	#1 to #60	●	561		
					p.88	p.112		
		Letter	A to Z	●	561			
					p.88	p.112		
		TiN	Fractional	1/16 to 1/2	●	561P		
					p.88	p.112		
	Wire		#1 to #52	●	561P			
				p.88	p.112			
		Black Oxide	Fractional	3/64 to 1/2	●	563		
					p.88	p.112		
Wire	#1 to #52		●	563				
			p.88	p.112				
	HSS-Co	Black Oxide	Letter	A to Z	●	563		
					p.88	p.112		
Fractional			3/64 to 1/2	●	6563			
			p.88	p.112				
	HSS-Co	Black Oxide	Wire	#1 to #52	●	6563		
					p.88	p.112		
Letter			A to Z	●	6563			
			p.88	p.112				
Taper Length	HSS	Black Oxide	Fractional	1/64 to 1/2	●	531		
						p.90	p.112	
	HSS-Co	Black Oxide	Fractional	1/16 to 3/4	●	6531		
			p.90	p.112				
	HSS	TiN	Fractional	1/16 to 1/2	●	545P		
			p.90	p.113				
Extra Length	HSS	Bright	Fractional	1/8 to 1	●	551		
						p.92	p.113	
	Fractional	1/8 to 1	●	551				
			p.92	p.113				
	HSS-Co	Black Oxide	Fractional	3/16 to 1/2	●	6551		
			p.92	p.113				
Oil Hole Drills	HSS-Co	Bright	Fractional	3/8 to 1 1/2	●	581		
			p.93	p.114				

Technical Data

DRILLS

DRILLS Cutting Condition

END MILLS

END MILLS Cutting Condition

TAPS

TAPS Cutting Condition

Others

● :Great ○ :Good △ :OK

	Drilling Depth *1				Workpiece Material																
	≤3D	≤5D	≤7D	>7D	Carbon Steel		Alloy Steel	Die Steel	Hardened Steel			Stainless Steel		Titanium Alloys	Nickel Alloys	Cast Iron		Aluminum			Copper Alloys
					Low Carbon	High Carbon			HRc			Austenitic	Martensitic			Soft	Hard	6061	Casting	High Si	
					1010,1018	1045,1065	4140,4330	D2	up to 35	35 to 45	45 to 65	300 Series	400 Series	< 200HB	> 200HB	7075	Si ≤ 12%	Si > 13%			
●				○	○	○												△		△	
●				○	○	○												△		△	
●				○	○	○												△		△	
●				○	●	●	△				△	△	△	△	○	△	△	△	△	△	
●				○	●	●	△				△	△	△	△	○	△	△	△	△	△	
●				○	○	○					△	△	△	△	△	△	△	△	△	△	
●				○	○	○					△	△	△	△	△	△	△	△	△	△	
●				○	○	○	△				△	○	○	△	△	△	△	△	△	△	
●				○	○	○	△				△	○	○	△	△	△	△	△	△	△	
●	●			○	○	○					△	△			△	△	△	△	△	△	
●	●			○	○	○	△				△	○			△	△	△	△	△	△	
●	●			○	●	●	△				△	△			○	△	△	△	△	△	
			●	○	○	○									△	△	○	△		△	
			●	○	○	○									△	△	○				
			●	○	○	○	△				△	○			△	△	△	△		△	
●	●	○		○	○	○	○				△	○	○	△	○	△	△	△		△	

*Some sizes does not meet this preference. Please make sure of flute length of each sizes before use.

Technical Data

DRILLS

DRILLS Cutting Condition

END MILLS

END MILLS Cutting Condition



TAPS

TAPS Cutting Condition

Others

46 Drills / Selection Chart

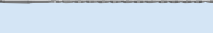
TAPER SHANK DRILLS

Drill Name	Material	Coating		Stock Size	Stock USA ● Japan ○	LIST No		
						Page Size	Page Cutting Condition	
Regular Shank	HSS	Black Oxide	Fractional	1/8 to 3 1/2	●	601		
Extra Length	HSS	Bright	Fractional	1/4 to 2 1/2	●	651		
						651		
Oil Hole Drills	HSS-Co	Bright	Fractional	3/8 to 1 1/2	●	683		

SPECIAL

Drill Name	Material	Coating		Stock Size	Stock USA ● Japan ○	LIST No		
						Page Size	Page Cutting Condition	
SILVER AND DEMING DRILLS	HSS	Bright	Fractional	1/2 to 1 1/2	●	575		
JOBBERS LENGTH/Set Drills	HSS, HSS-Co	Black Oxide, Bright	Several	Several	●	599		
						599		

Technical Data

DRILLS

DRILLS
Cutting Condition

END MILLS

END MILLS
Cutting Condition

TAPS

TAPS
Cutting Condition

Others

●:Great ○:Good △:OK

	Drilling Depth *1				Workpiece Material																
	≤3D	≤5D	≤7D	>7D	Carbon Steel		Alloy Steel	Die Steel	Hardened Steel			Stainless Steel		Titanium Alloys	Nickel Alloys	Cast Iron		Aluminum			Copper Alloys
					Low Carbon	High Carbon			HRC			Austenitic	Martensitic			Soft	Hard	6061	Casting	High Si	
					1010,1018	1045,1065	4140,4330	D2	up to 35	35 to 45	45 to 65	300 Series	400 Series	< 200HB	> 200HB	7075	Si ≤ 12%	Si > 13%			
●	○			○	○	○										△		△	△		△
			●	○	○	○												○	△		△
			●	○	○	○												○	△		△
	●	●	○		●	●	●					△	○	○	△	○	△	△	△		△

●:Great ○:Good △:OK

	Drilling Depth *1				Workpiece Material																
	≤3D	≤5D	≤7D	>7D	Carbon Steel		Alloy Steel	Die Steel	Hardened Steel			Stainless Steel		Titanium Alloys	Nickel Alloys	Cast Iron		Aluminum			Copper Alloys
					Low Carbon	High Carbon			HRC			Austenitic	Martensitic			Soft	Hard	6061	Casting	High Si	
					1010,1018	1045,1065	4140,4330	D2	up to 35	35 to 45	45 to 65	300 Series	400 Series	< 200HB	> 200HB	7075	Si ≤ 12%	Si > 13%			
●				○	○	○													△		△
●	●	●		○	○	○	△									△		△	△		△

*Some sizes does not meet this preference. Please make sure of flute length of each sizes before use.

Technical Data

DRILLS

DRILLS Cutting Condition

END MILLS

END MILLS Cutting Condition

TAPS

TAPS Cutting Condition

Others

STUB LENGTH SG-ESS / METRIC SIZES

Technical Data

List No.7572P High Performance



Range 1.0 to 20.0

PM-HSS SG COATED



This drill having stub length is suited for high-speed drilling and precise positioning and diameter. This is useful in material from Carbon Steels and Stainless Steels to Aluminum.



(Unit) : mm

DRILLS

DRILLS Cutting Condition

END MILLS

END MILLS Cutting Condition

TAPS

TAPS Cutting Condition

Others

EDP No.	Size	Decimal	Wire Equivalent	Flute Length	Overall Length	Shank Dia.
0573780	1.00	0.0394		6	38	3
0693862	1.01	0.0398		6	38	3
0693879	1.02	0.0402	#60	6	38	3
0693885	1.03	0.0406		6	38	3
0693891	1.04	0.0409	#59	6	38	3
0575347	1.05	0.0413		6	38	3
0693907	1.06	0.0417		6	38	3
0693913	1.07	0.0421	#58	7	39	3
0693920	1.08	0.0425		7	39	3
0693936	1.09	0.0429	#57	7	39	3
0573797	1.10	0.0433		7	39	3
0693942	1.11	0.0437		7	39	3
0693959	1.12	0.0441		7	39	3
0693965	1.13	0.0445		7	39	3
0693971	1.14	0.0449		7	39	3
0575353	1.15	0.0453		7	39	3
0693988	1.16	0.0457		7	39	3
0693994	1.17	0.0461		7	39	3
0694009	1.18	0.0465	#56	7	39	3
0694015	1.19	0.0469	3/64"	8	40	3
0573802	1.20	0.0472		8	40	3
0694021	1.21	0.0476		8	40	3
0694038	1.22	0.0480		8	40	3
0694044	1.23	0.0484		8	40	3
0694050	1.24	0.0488		8	40	3
0575360	1.25	0.0492		8	40	3
0694067	1.26	0.0496		8	40	3
0694073	1.27	0.0500		8	40	3
0694080	1.28	0.0504		8	40	3
0694096	1.29	0.0508		8	40	3
0573819	1.30	0.0512		8	40	3
0694101	1.31	0.0516		8	40	3
0694118	1.32	0.0520	#55	8	40	3
0694124	1.33	0.0524		9	41	3
0694130	1.34	0.0528		9	41	3
0575376	1.35	0.0531		9	41	3
0694147	1.36	0.0535		9	41	3
0694153	1.37	0.0539		9	41	3
0694160	1.38	0.0543		9	41	3
0694176	1.39	0.0547		9	41	3
0573825	1.40	0.0551		9	41	3
0694182	1.41	0.0555		9	41	3
0694199	1.42	0.0559		9	41	3
0694204	1.43	0.0563		9	41	3
0694210	1.44	0.0567		9	41	3
0575382	1.45	0.0571		9	41	3
0694227	1.46	0.0575		9	41	3
0694233	1.47	0.0579		9	41	3
0694240	1.48	0.0583		9	41	3
0694256	1.49	0.0587		9	41	3
0573831	1.50	0.0591		9	41	3
0694262	1.51	0.0594	#53	10	42	3
0694279	1.52	0.0598		10	42	3
0694285	1.53	0.0602		10	42	3
0694291	1.54	0.0606		10	42	3
0575399	1.55	0.0610		10	42	3
0694307	1.56	0.0614		10	42	3
0694313	1.57	0.0618		10	42	3
0694320	1.58	0.0622		10	42	3
0694336	1.59	0.0626	1/16	10	42	3
0573848	1.60	0.0630		10	42	3
0694342	1.61	0.0634	#52	10	42	3
0694359	1.62	0.0638		10	42	3
0694365	1.63	0.0642		10	42	3
0694371	1.64	0.0646		10	42	3
0575404	1.65	0.0650		10	42	3
0694388	1.66	0.0654		10	42	3
0694394	1.67	0.0657		10	42	3
0694400	1.68	0.0661		10	42	3
0694416	1.69	0.0665		10	42	3
0573854	1.70	0.0669		10	42	3
0694422	1.71	0.0673		11	43	3
0694439	1.72	0.0677		11	43	3
0694445	1.73	0.0681		11	43	3

EDP No.	Size	Decimal	Wire Equivalent	Flute Length	Overall Length	Shank Dia.
0694451	1.74	0.0685		11	43	3
0575410	1.75	0.0689		11	43	3
0694468	1.76	0.0693		11	43	3
0694474	1.77	0.0697		11	43	3
0694480	1.78	0.0701	#50	11	43	3
0694497	1.79	0.0705		11	43	3
0573860	1.80	0.0709		11	43	3
0694502	1.81	0.0713		11	43	3
0694519	1.82	0.0717		11	43	3
0694525	1.83	0.0720		11	43	3
0694531	1.84	0.0724		11	43	3
0575427	1.85	0.0728		11	43	3
0694548	1.86	0.0732	#49	11	43	3
0694554	1.87	0.0736		11	43	3
0694560	1.88	0.0740		11	43	3
0694577	1.89	0.0744		11	43	3
0573877	1.90	0.0748		11	43	3
0694583	1.91	0.0752		12	44	3
0694590	1.92	0.0756		12	44	3
0694605	1.93	0.0760	#48	12	44	3
0694611	1.94	0.0764		12	44	3
0575433	1.95	0.0768		12	44	3
0694628	1.96	0.0772		12	44	3
0694634	1.97	0.0776		12	44	3
0694640	1.98	0.0780	5/64	12	44	3
0694657	1.99	0.0783	#47	12	44	3
0572514	2.00	0.0787		12	44	3
0694663	2.01	0.0791		12	44	3
0694670	2.02	0.0795		12	44	3
0694686	2.03	0.0799		12	44	3
0694692	2.04	0.0803		12	44	3
0575440	2.05	0.0807		12	44	3
0694708	2.06	0.0811	#46	12	44	3
0694714	2.07	0.0815		12	44	3
0694720	2.08	0.0819	#45	12	44	3
0694737	2.09	0.0823		12	44	3
0572520	2.10	0.0827		12	44	3
0694743	2.11	0.0831		12	44	3
0694750	2.12	0.0835		12	44	3
0694766	2.13	0.0839		13	45	3
0694772	2.14	0.0843		13	45	3
0575456	2.15	0.0846		13	45	3
0694789	2.16	0.0850		13	45	3
0694795	2.17	0.0854		13	45	3
0694800	2.18	0.0858	#44	13	45	3
0694817	2.19	0.0862		13	45	3
0572537	2.20	0.0866		13	45	3
0694823	2.21	0.0870		13	45	3
0694830	2.22	0.0874		13	45	3
0694846	2.23	0.0878		13	45	3
0694852	2.24	0.0882		13	45	3
0575462	2.25	0.0886		13	45	3
0694869	2.26	0.0890	#43	13	45	3
0694875	2.27	0.0894		13	45	3
0694881	2.28	0.0898		13	45	3
0694898	2.29	0.0902		13	45	3
0572543	2.30	0.0906		13	45	3
0694903	2.31	0.0909		13	45	3
0694910	2.32	0.0913		13	45	3
0694926	2.33	0.0917		13	45	3
0694932	2.34	0.0921		13	45	3
0575479	2.35	0.0925		13	45	3
0694949	2.36	0.0929		13	45	3
0694955	2.37	0.0933	#42	14	46	3
0694961	2.38	0.0937	3/32	14	46	3
0694978	2.39	0.0941		14	46	3
0572550	2.40	0.0945		14	46	3
0694984	2.41	0.0949		14	46	3
0694990	2.42	0.0953		14	46	3
0695005	2.43	0.0957		14	46	3
0695011	2.44	0.0961	#41	14	46	3
0575485	2.45	0.0965		14	46	3
0695028	2.46	0.0969		14	46	3
0695034	2.47	0.0972		14	46	3

0.01mm size Diameter Tolerance : 0~-.009mm

STUB LENGTH SG-ESS / METRIC SIZES

(Unit) : mm

EDP No.	Size	Decimal	Wire Equivalent	Flute Length	Overall Length	Shank Dia.
0695040	2.48	0.0976		14	46	3
0695057	2.49	0.0980	#40	14	46	3
0572566	2.50	0.0984		14	46	3
0695063	2.51	0.0988		14	46	3
0695070	2.52	0.0992		14	46	3
0695086	2.53	0.0996	#39	14	46	3
0695092	2.54	0.1000		14	46	3
0575491	2.55	0.1004		14	46	3
0695108	2.56	0.1008		14	46	3
0695114	2.57	0.1012		14	46	3
0695120	2.58	0.1016	#38	14	46	3
0695137	2.59	0.1020		14	46	3
0572572	2.60	0.1024		14	46	3
0695143	2.61	0.1028		14	46	3
0695150	2.62	0.1031		14	46	3
0695166	2.63	0.1035		14	46	3
0695172	2.64	0.1039	#37	14	46	3
0575507	2.65	0.1043		14	46	3
0695189	2.66	0.1047		16	48	3
0695195	2.67	0.1051		16	48	3
0695200	2.68	0.1055		16	48	3
0695217	2.69	0.1059		16	48	3
0572589	2.70	0.1063		16	48	3
0695223	2.71	0.1067	#36	16	48	3
0695230	2.72	0.1071		16	48	3
0695246	2.73	0.1075		16	48	3
0695252	2.74	0.1079		16	48	3
0575513	2.75	0.1083		16	48	3
0695269	2.76	0.1087		16	48	3
0695275	2.77	0.1091		16	48	3
0695281	2.78	0.1094	7/64	16	48	3
0695298	2.79	0.1098	#35	16	48	3
0572595	2.80	0.1102		16	48	3
0695303	2.81	0.1106		16	48	3
0695310	2.82	0.1110	#34	16	48	3
0695326	2.83	0.1114		16	48	3
0695332	2.84	0.1118		16	48	3
0575520	2.85	0.1122		16	48	3
0695349	2.86	0.1126		16	48	3
0695355	2.87	0.1130	#33	16	48	3
0695361	2.88	0.1134		16	48	3
0695378	2.89	0.1138		16	48	3
0572600	2.90	0.1142		16	48	3
0695384	2.91	0.1146		16	48	3
0695390	2.92	0.1150		16	48	3
0695406	2.93	0.1154		16	48	3
0695412	2.94	0.1157		16	48	3
0575536	2.95	0.1161		16	48	3
0695429	2.96	0.1165		16	48	3
0695435	2.97	0.1169		16	48	3
0695441	2.98	0.1173		16	48	3
0695458	2.99	0.1177		16	48	3
0572617	3.00	0.1181		16	48	3
0695464	3.01	0.1185		18	50	4
0695470	3.02	0.1189		18	50	4
0695487	3.03	0.1193		18	50	4
0695493	3.04	0.1197		18	50	4
0575542	3.05	0.1201		18	50	4
0695509	3.06	0.1205		18	50	4
0695515	3.07	0.1209		18	50	4
0695521	3.08	0.1213		18	50	4
0695538	3.09	0.1217		18	50	4
0572623	3.10	0.1220		18	50	4
0695544	3.11	0.1224		18	50	4
0695550	3.12	0.1228		18	50	4
0695567	3.13	0.1232		18	50	4
0695573	3.14	0.1236		18	50	4
0575599	3.15	0.1240		18	50	4
0695580	3.16	0.1244		18	50	4
0695596	3.17	0.1248		18	50	4
0695601	3.18	0.1252	1/8	18	50	4
0695618	3.19	0.1256		18	50	4
0572630	3.20	0.1260		18	50	4
0695624	3.21	0.1264		18	50	4

EDP No.	Size	Decimal	Wire Equivalent	Flute Length	Overall Length	Shank Dia.
0695630	3.22	0.1268		18	50	4
0695647	3.23	0.1272		18	50	4
0695653	3.24	0.1276		18	50	4
0575565	3.25	0.1280		18	50	4
0695660	3.26	0.1283	#30	18	50	4
0695676	3.27	0.1287		18	50	4
0695682	3.28	0.1291		18	50	4
0695699	3.29	0.1295		18	50	4
0572646	3.30	0.1299		18	50	4
0695704	3.31	0.1303		18	50	4
0695710	3.32	0.1307		18	50	4
0695727	3.33	0.1311		18	50	4
0695733	3.34	0.1315		18	50	4
0575571	3.35	0.1319		18	50	4
0695740	3.36	0.1323		20	52	4
0695756	3.37	0.1327		20	52	4
0695762	3.38	0.1331		20	52	4
0695779	3.39	0.1335		20	52	4
0572652	3.40	0.1339		20	52	4
0695785	3.41	0.1343		20	52	4
0695791	3.42	0.1346		20	52	4
0695807	3.43	0.1350		20	52	4
0695813	3.44	0.1354		20	52	4
0575588	3.45	0.1358		20	52	4
0695820	3.46	0.1362		20	52	4
0695836	3.47	0.1366	#29	20	52	4
0695842	3.48	0.1370		20	52	4
0695859	3.49	0.1374		20	52	4
0572669	3.50	0.1378		20	52	4
0695865	3.51	0.1382		20	52	4
0695871	3.52	0.1386		20	52	4
0695888	3.53	0.1390		20	52	4
0695894	3.54	0.1394		20	52	4
0575594	3.55	0.1398		20	52	4
0695900	3.56	0.1402		20	52	4
0695916	3.57	0.1406	#28,9/64	20	52	4
0695922	3.58	0.1409		20	52	4
0695939	3.59	0.1413		20	52	4
0572675	3.60	0.1417		20	52	4
0695945	3.61	0.1421		20	52	4
0695951	3.62	0.1425		20	52	4
0695968	3.63	0.1429		20	52	4
0695974	3.64	0.1433		20	52	4
0575600	3.65	0.1437		20	52	4
0695980	3.66	0.1441	#27	20	52	4
0695997	3.67	0.1445		20	52	4
0696001	3.68	0.1449		20	52	4
0696018	3.69	0.1453		20	52	4
0572681	3.70	0.1457		20	52	4
0696024	3.71	0.1461		20	52	4
0696030	3.72	0.1465		20	52	4
0696047	3.73	0.1469	#26	20	52	4
0696053	3.74	0.1472		20	52	4
0575616	3.75	0.1476		20	52	4
0696060	3.76	0.1480		22	54	4
0696076	3.77	0.1484		22	54	4
0696082	3.78	0.1488		22	54	4
0696099	3.79	0.1492		22	54	4
0572698	3.80	0.1496		22	54	4
0696104	3.81	0.1500		22	54	4
0696110	3.82	0.1504		22	54	4
0696127	3.83	0.1508		22	54	4
0696133	3.84	0.1512		22	54	4
0575622	3.85	0.1516		22	54	4
0696140	3.86	0.1520	#24	22	54	4
0696156	3.87	0.1524		22	54	4
0696162	3.88	0.1528		22	54	4
0696179	3.89	0.1531		22	54	4
0572703	3.90	0.1535		22	54	4
0696185	3.91	0.1539	#23	22	54	4
0696191	3.92	0.1543		22	54	4
0696207	3.93	0.1547		22	54	4
0696213	3.94	0.1551		22	54	4
0575639	3.95	0.1555		22	54	4

0.01mm size Diameter Tolerance : 0~-.009mm

STUB LENGTH SG-ESS / METRIC SIZES

(Unit) : mm

EDP No.	Size	Decimal	Wire Equivalent	Flute Length	Overall Length	Shank Dia.
0696220	3.96	0.1559		22	54	4
0696236	3.97	0.1563	5/32	22	54	4
0696242	3.98	0.1567		22	54	4
0696259	3.99	0.1571	#22	22	54	4
0572710	4.00	0.1575		22	54	4
0696265	4.01	0.1579		22	66	6
0696271	4.02	0.1583		22	66	6
0696288	4.03	0.1587		22	66	6
0696294	4.04	0.1591	#21	22	66	6
0575645	4.05	0.1594		22	66	6
0696300	4.06	0.1598		22	66	6
0696316	4.07	0.1602		22	66	6
0696322	4.08	0.1606		22	66	6
0696339	4.09	0.1610	#20	22	66	6
0572726	4.10	0.1614		22	66	6
0696345	4.11	0.1618		22	66	6
0696351	4.12	0.1622		22	66	6
0696368	4.13	0.1626		22	66	6
0696374	4.14	0.1630		22	66	6
0575651	4.15	0.1634		22	66	6
0696380	4.16	0.1638		22	66	6
0696397	4.17	0.1642		22	66	6
0696402	4.18	0.1646		22	66	6
0696419	4.19	0.1650		22	66	6
0572732	4.20	0.1654		22	66	6
0696425	4.21	0.1657		22	66	6
0696431	4.22	0.1661	#19	22	66	6
0696448	4.23	0.1665		22	66	6
0696454	4.24	0.1669		22	66	6
0575668	4.25	0.1673		22	66	6
0696460	4.26	0.1677		24	68	6
0696477	4.27	0.1681		24	68	6
0696483	4.28	0.1685		24	68	6
0696490	4.29	0.1689		24	68	6
0572749	4.30	0.1693		24	68	6
0696505	4.31	0.1697		24	68	6
0696511	4.32	0.1701		24	68	6
0696528	4.33	0.1705		24	68	6
0696534	4.34	0.1709		24	68	6
0575674	4.35	0.1713		24	68	6
0696540	4.36	0.1717		24	68	6
0696557	4.37	0.1720	11/64	24	68	6
0696563	4.38	0.1724		24	68	6
0696570	4.39	0.1728		24	68	6
0572755	4.40	0.1732		24	68	6
0696586	4.41	0.1736		24	68	6
0696592	4.42	0.1740		24	68	6
0696608	4.43	0.1744		24	68	6
0696614	4.44	0.1748		24	68	6
0575680	4.45	0.1752		24	68	6
0696620	4.46	0.1756		24	68	6
0696637	4.47	0.1760		24	68	6
0696643	4.48	0.1764		24	68	6
0696650	4.49	0.1768		24	68	6
0572761	4.50	0.1772		24	68	6
0696666	4.51	0.1776		24	68	6
0696672	4.52	0.1780		24	68	6
0696689	4.53	0.1783		24	68	6
0696695	4.54	0.1787		24	68	6
0575697	4.55	0.1791		24	68	6
0696700	4.56	0.1795		24	68	6
0696717	4.57	0.1799	#15	24	68	6
0696723	4.58	0.1803		24	68	6
0696730	4.59	0.1807		24	68	6
0572778	4.60	0.1811		24	68	6
0696746	4.61	0.1815		24	68	6
0696752	4.62	0.1819	#14	24	68	6
0696769	4.63	0.1823		24	68	6
0696775	4.64	0.1827		24	68	6
0575702	4.65	0.1831		24	68	6
0696781	4.66	0.1835		24	68	6
0696798	4.67	0.1839		24	68	6
0696803	4.68	0.1843		24	68	6
0696810	4.69	0.1846		24	68	6

EDP No.	Size	Decimal	Wire Equivalent	Flute Length	Overall Length	Shank Dia.
0572784	4.70	0.1850		24	68	6
0696826	4.71	0.1854		24	68	6
0696832	4.72	0.1858		24	68	6
0696849	4.73	0.1862		24	68	6
0696855	4.74	0.1866		24	68	6
0575719	4.75	0.1870		24	68	6
0696861	4.76	0.1874	3/16	26	70	6
0696878	4.77	0.1878		26	70	6
0696884	4.78	0.1882		26	70	6
0696890	4.79	0.1886		26	70	6
0572790	4.80	0.1890		26	70	6
0696906	4.81	0.1894		26	70	6
0696912	4.82	0.1898		26	70	6
0696929	4.83	0.1902		26	70	6
0696935	4.84	0.1906		26	70	6
0575725	4.85	0.1909		26	70	6
0696941	4.86	0.1913		26	70	6
0696958	4.87	0.1917		26	70	6
0696964	4.88	0.1921		26	70	6
0696970	4.89	0.1925		26	70	6
0572806	4.90	0.1929		26	70	6
0696987	4.91	0.1933	#10	26	70	6
0696993	4.92	0.1937		26	70	6
0697008	4.93	0.1941		26	70	6
0697014	4.94	0.1945		26	70	6
0575731	4.95	0.1949		26	70	6
0697020	4.96	0.1953		26	70	6
0697037	4.97	0.1957		26	70	6
0697043	4.98	0.1961	#9	26	70	6
0697050	4.99	0.1965		26	70	6
0572812	5.00	0.1969		26	70	6
0697066	5.01	0.1972		26	70	6
0697072	5.02	0.1976		26	70	6
0697089	5.03	0.1980		26	70	6
0697095	5.04	0.1984		26	70	6
0575748	5.05	0.1988		26	70	6
0697100	5.06	0.1992		26	70	6
0697117	5.07	0.1996		26	70	6
0697123	5.08	0.2000		26	70	6
0697130	5.09	0.2004		26	70	6
0572829	5.10	0.2008		26	70	6
0697146	5.11	0.2012	#7	26	70	6
0697152	5.12	0.2016		26	70	6
0697169	5.13	0.2020		26	70	6
0697175	5.14	0.2024		26	70	6
0575754	5.15	0.2028		26	70	6
0697181	5.16	0.2031	13/64	26	70	6
0697198	5.17	0.2035		26	70	6
0697203	5.18	0.2039	#6	26	70	6
0697210	5.19	0.2043		26	70	6
0572835	5.20	0.2047		26	70	6
0697226	5.21	0.2051		26	70	6
0697232	5.22	0.2055	#5	26	70	6
0697249	5.23	0.2059		26	70	6
0697255	5.24	0.2063		26	70	6
0575760	5.25	0.2067		26	70	6
0697261	5.26	0.2071		26	70	6
0697278	5.27	0.2075		26	70	6
0697284	5.28	0.2079		26	70	6
0697290	5.29	0.2083		26	70	6
0572841	5.30	0.2087		26	70	6
0697306	5.31	0.2091	#4	28	72	6
0697312	5.32	0.2094		28	72	6
0697329	5.33	0.2098		28	72	6
0697335	5.34	0.2102		28	72	6
0575777	5.35	0.2106		28	72	6
0697341	5.36	0.2110		28	72	6
0697358	5.37	0.2114		28	72	6
0697364	5.38	0.2118		28	72	6
0697370	5.39	0.2122		28	72	6
0572858	5.40	0.2126		28	72	6
0697387	5.41	0.2130	#3	28	72	6
0697393	5.42	0.2134		28	72	6
0697409	5.43	0.2138		28	72	6

0.01mm size Diameter Tolerance : 0~-.009mm

Technical Data

DRILLS

DRILLS Cutting Condition

END MILLS

END MILLS Cutting Condition

TAPS

TAPS Cutting Condition

Others

(Unit) : mm

EDP No.	Size	Decimal	Wire Equivalent	Flute Length	Overall Length	Shank Dia.
0697415	5.44	0.2142		28	72	6
0575783	5.45	0.2146		28	72	6
0697421	5.46	0.2150		28	72	6
0697438	5.47	0.2154		28	72	6
0697444	5.48	0.2157		28	72	6
0697450	5.49	0.2161		28	72	6
0572864	5.50	0.2165		28	72	6
0697467	5.51	0.2169		28	72	6
0697473	5.52	0.2173		28	72	6
0697480	5.53	0.2177		28	72	6
0697496	5.54	0.2181		28	72	6
0575790	5.55	0.2185		28	72	6
0697501	5.56	0.2189	7/32	28	72	6
0697518	5.57	0.2193		28	72	6
0697524	5.58	0.2197		28	72	6
0697530	5.59	0.2201		28	72	6
0572870	5.60	0.2205		28	72	6
0697547	5.61	0.2209	#2	28	72	6
0697553	5.62	0.2213		28	72	6
0697560	5.63	0.2217		28	72	6
0697576	5.64	0.2220		28	72	6
0575805	5.65	0.2224		28	72	6
0697582	5.66	0.2228		28	72	6
0697599	5.67	0.2232		28	72	6
0697604	5.68	0.2236		28	72	6
0697610	5.69	0.2240		28	72	6
0572887	5.70	0.2244		28	72	6
0697627	5.71	0.2248		28	72	6
0697633	5.72	0.2252		28	72	6
0697640	5.73	0.2256		28	72	6
0697656	5.74	0.2260		28	72	6
0575811	5.75	0.2264		28	72	6
0697662	5.76	0.2268		28	72	6
0697679	5.77	0.2272		28	72	6
0697685	5.78	0.2276		28	72	6
0697691	5.79	0.2280	#1	28	72	6
0572893	5.80	0.2283		28	72	6
0697707	5.81	0.2287		28	72	6
0697713	5.82	0.2291		28	72	6
0697720	5.83	0.2295		28	72	6
0697736	5.84	0.2299		28	72	6
0575828	5.85	0.2303		28	72	6
0697742	5.86	0.2307		28	72	6
0697759	5.87	0.2311		28	72	6
0697765	5.88	0.2315		28	72	6
0697771	5.89	0.2319		28	72	6
0572909	5.90	0.2323		28	72	6
0697788	5.91	0.2327		28	72	6
0697794	5.92	0.2331		28	72	6
0697800	5.93	0.2335		28	72	6
0697816	5.94	0.2339		28	72	6
0575834	5.95	0.2343		28	72	6
0697822	5.96	0.2346		28	72	6
0697839	5.97	0.2350		28	72	6
0697845	5.98	0.2354		28	72	6
0697851	5.99	0.2358		28	72	6
0572915	6.00	0.2362		28	72	6
0572921	6.1	0.2402		31	75	8
0572938	6.2	0.2441		31	75	8
0572944	6.3	0.2480		31	75	8
0572950	6.4	0.2520		31	75	8
0572967	6.5	0.2559		31	75	8
0572973	6.6	0.2598		31	75	8
0572980	6.7	0.2638		31	75	8
0572996	6.8	0.2677		34	78	8
0573000	6.9	0.2717		34	78	8
0573017	7.0	0.2756		34	78	8
0573023	7.1	0.2795		34	78	8
0573030	7.2	0.2835		34	78	8
0573046	7.3	0.2874		34	78	8
0573052	7.4	0.2913		34	78	8

EDP No.	Size	Decimal	Wire Equivalent	Flute Length	Overall Length	Shank Dia.
0573069	7.5	0.2953		34	78	8
0573075	7.6	0.2992		37	81	8
0573081	7.7	0.3031		37	81	8
0573098	7.8	0.3071		37	81	8
0573103	7.9	0.3110		37	81	8
0573110	8.0	0.3150		37	81	8
0573126	8.1	0.3189		37	87	10
0573132	8.2	0.3228		37	87	10
0573149	8.3	0.3268		37	87	10
0573155	8.4	0.3307		37	87	10
0573161	8.5	0.3346		37	87	10
0573178	8.6	0.3386		40	90	10
0573184	8.7	0.3425		40	90	10
0573190	8.8	0.3465		40	90	10
0573206	8.9	0.3504		40	90	10
0573212	9.0	0.3543		40	90	10
0573229	9.1	0.3583		40	90	10
0573235	9.2	0.3622		40	90	10
0573241	9.3	0.3661		40	90	10
0573258	9.4	0.3701		40	90	10
0573264	9.5	0.3740		40	90	10
0573270	9.6	0.3780		43	93	10
0573287	9.7	0.3819		43	93	10
0573293	9.8	0.3858		43	93	10
0573309	9.9	0.3898		43	93	10
0573315	10.0	0.3937		43	93	10
0573321	10.1	0.3976		43	100	12
0573338	10.2	0.4016		43	100	12
0573344	10.3	0.4055		43	100	12
0573350	10.4	0.4094		43	100	12
0573367	10.5	0.4134		43	100	12
0573373	10.6	0.4173		43	100	12
0573380	10.7	0.4213		47	104	12
0573396	10.8	0.4252		47	104	12
0573401	10.9	0.4291		47	104	12
0573418	11.0	0.4331		47	104	12
0573424	11.1	0.4370		47	104	12
0573430	11.2	0.4409		47	104	12
0573447	11.3	0.4449		47	104	12
0573453	11.4	0.4488		47	104	12
0573460	11.5	0.4528		47	104	12
0573476	11.6	0.4567		47	104	12
0573482	11.7	0.4606		47	104	12
0573499	11.8	0.4646		47	104	12
0573504	11.9	0.4685		51	108	12
0573510	12.0	0.4724		51	108	12
0573527	12.1	0.4764		51	108	12
0573533	12.2	0.4803		51	108	12
0573540	12.3	0.4843		51	108	12
0573556	12.4	0.4882		51	108	12
0573562	12.5	0.4921		51	108	12
0573579	12.6	0.4961		51	108	12
0573585	12.7	0.5000		51	108	12
0573591	12.8	0.5039		51	108	12
0573607	12.9	0.5079		51	108	12
0573613	13.0	0.5118		51	108	12
0573620	13.5	0.5315		72	132	16
0573636	14.0	0.5512		72	132	16
0573642	14.5	0.5709		76	136	16
0573659	15.0	0.5906		76	142	20
0573665	15.5	0.6102		80	146	20
0573671	16.0	0.6299		80	146	20
0573688	16.5	0.6496		84	150	20
0573694	17.0	0.6693		84	150	20
0573700	17.5	0.6890		87	153	20
0573716	18.0	0.7087		87	153	20
0573722	18.5	0.7283		90	156	20
0573739	19.0	0.7480		90	164	25
0573745	19.5	0.7677		94	168	25
0573751	20.0	0.7874		94	168	25

0.01mm size Diameter Tolerance : 0~-.009mm

STUB LENGTH SG-ESS / FRACTIONAL SIZES

List No.7573P High Performance

PM-HSS SG COATED



Range 3/32 to 3/4



This drill having stub length is suited for high-speed drilling and precise positioning and diameter. This is useful in material from Carbon Steels and Stainless Steels to Aluminum.

Technical Data

DRILLS

DRILLS Cutting Condition

END MILLS

END MILLS Cutting Condition

TAPS

TAPS Cutting Condition

Others

Size		Decimal	Metric	Flute	Overall	Shank
Fractional	Wire	Equivalent	Equivalent	Length	Length	Dia.
	#45	0.0820	2.08	3/4	2	1/8
	#44	0.0860	2.18	3/4	2	1/8
	#43	0.0890	2.26	3/4	2	1/8
	#42	0.0935	2.37	3/4	2	1/8
3/32		0.0938	2.38	1/2	1 3/4	1/8
	#41	0.0960	2.44	13/16	2 1/16	1/8
	#40	0.0980	2.49	13/16	2 1/16	1/8
	#39	0.0995	2.53	13/16	2 1/4	1/8
	#38	0.1015	2.58	13/16	2 1/4	1/8
	#37	0.1040	2.64	13/16	2 1/4	1/8
	#36	0.1065	2.71	13/16	2 1/4	1/8
7/64		0.1094	2.78	5/8	1 7/8	1/8
	#34	0.1110	2.82	7/8	2 5/16	1/8
	#33	0.1130	2.87	7/8	2 5/16	1/8
1/8		0.1250	3.18	3/4	2	1/8
	#30	0.1285	3.26	15/16	2 3/8	3/16
	#29	0.1365	3.47	15/16	2 3/8	3/16
	#28	0.1405	3.57	15/16	2 3/8	3/16
9/64		0.1406	3.57	13/16	2 1/8	3/16
	#27	0.1440	3.66	1	2 7/16	3/16
	#26	0.1470	3.73	1	2 7/16	3/16
	#25	0.1495	3.80	1	2 7/16	3/16
	#24	0.1520	3.86	1	2 7/16	3/16
	#23	0.1540	3.91	1	2 7/16	3/16
5/32		0.1563	3.97	13/16	2 1/8	3/16
	#22	0.1570	3.99	1 1/16	2 1/2	3/16
	#21	0.1590	4.04	1 1/16	2 1/2	3/16
	#20	0.1610	4.09	1 1/16	2 1/2	3/16
	#19	0.1660	4.22	1 1/16	2 1/2	3/16
11/64		0.1719	4.37	1	2 3/8	3/16
	#15	0.1800	4.57	1 1/18	2 9/16	3/16
	#14	0.1820	4.62	1 1/18	2 9/16	3/16
3/16		0.1875	4.76	1	2 3/8	3/16
	#10	0.1935	4.91	1 3/16	3	1/4
	#9	0.1960	4.98	1 3/16	3	1/4
	#8	0.1990	5.05	1 3/16	3	1/4
	#7	0.2010	5.11	1 3/16	3	1/4
13/64		0.2031	5.16	1 1/8	2 7/8	1/4
	#6	0.2040	5.18	1 1/4	3 1/16	1/4
	#5	0.2055	5.22	1 1/4	3 1/16	1/4
	#4	0.2090	5.31	1 1/4	3 1/16	1/4
	#3	0.2130	5.41	1 1/4	3 1/16	1/4
7/32		0.2188	5.56	1 1/8	2 7/8	1/4
	#2	0.2210	5.61	1 5/16	3 1/8	1/4
	#1	0.2280	5.79	1 5/16	3 1/8	1/4

Size		Decimal	Metric	Flute	Overall	Shank
Fractional	Letter	Equivalent	Equivalent	Length	Length	Dia.
15/64		0.2344	5.95	1 1/4	3	1/4
	B	0.2380	6.05	1 3/8	3 3/16	1/4
	C	0.2420	6.15	1 3/8	3 3/16	1/4
	D	0.2460	6.25	1 3/8	3 3/16	1/4
1/4		0.2500	6.35	1 1/4	3	1/4
	F	0.2570	6.53	1 7/16	3 1/4	3/8
	G	0.2610	6.63	1 7/16	3 1/4	3/8
17/64		0.2656	6.75	1 3/8	3 3/16	3/8
	I	0.2720	6.91	1 1/2	3 5/16	3/8
	J	0.2770	7.04	1 1/2	3 5/16	3/8
9/32		0.2813	7.14	1 3/8	3 3/16	3/8
	L	0.2900	7.37	1 9/16	3 3/8	3/8
	M	0.2950	7.49	1 9/16	3 3/8	3/8
19/64		0.2969	7.54	1 3/8	3 3/16	3/8
	N	0.3020	7.67	1 5/8	3 7/16	3/8
5/16		0.3125	7.94	1 1/2	3 3/8	3/8
	O	0.3160	8.03	1 11/16	3 1/2	3/8
21/64		0.3281	8.33	1 1/2	3 3/8	3/8
	Q	0.3320	8.43	1 11/16	3 1/2	3/8
	R	0.3390	8.61	1 11/16	3 1/2	3/8
11/32		0.3438	8.73	1 5/8	3 1/2	3/8
23/64		0.3594	9.13	1 5/8	3 1/2	3/8
	U	0.3680	9.35	1 13/16	3 5/8	3/8
3/8		0.3750	9.53	1 5/8	3 1/2	3/8
	V	0.3770	9.58	1 7/8	3 31/32	1/2
25/64		0.3906	9.92	1 11/16	3 7/8	1/2
	X	0.3970	10.08	1 15/16	4 1/32	1/2
	Y	0.4040	10.26	1 15/16	4 1/32	1/2
13/32		0.4063	10.32	1 11/16	3 7/8	1/2
	Z	0.4130	10.49	2	4 3/32	1/2
27/64		0.4219	10.72	1 7/8	4 1/8	1/2
7/16		0.4375	11.11	1 7/8	4 1/8	1/2
29/64		0.4531	11.51	1 7/8	4 1/8	1/2
15/32		0.4688	11.91	2	4 1/4	1/2
31/64		0.4844	12.30	2	4 1/4	1/2
1/2		0.5000	12.70	2	4 1/4	1/2
17/32		0.5313	13.49	2 7/8	5 3/16	5/8
9/16		0.5625	14.29	3	5 3/8	5/8
19/32		0.5938	15.08	3	5 5/8	3/4
5/8		0.6250	15.88	3 3/16	5 3/4	3/4
21/32		0.6563	16.67	3 3/8	5 15/16	3/4
11/16		0.6875	17.46	3 7/16	6	3/4
23/32		0.7188	18.26	3 7/16	6	7/8
3/4		0.7500	19.05	3 9/16	6 1/2	7/8

1 per tube

List No.7570P High Performance



Range 2.0 to 20.0 mm

PM-HSS SG COATED



Jobber length drill provides stable high-speed drilling and long tool life in a variety of materials; not suitable for Austenitic Stainless Steel.

(Unit) : mm

Size	Decimal Equivalent	Flute Length	Overall Length	Shank Dia.
2.0	0.0787	24	56	3
2.1	0.0827	24	56	3
2.2	0.0866	25	56	3
2.3	0.0906	25	56	3
2.4	0.0945	30	61	3
2.5	0.0984	30	61	3
2.6	0.1024	30	61	3
2.7	0.1063	33	64	3
2.8	0.1102	33	64	3
2.9	0.1142	33	64	3
3.0	0.1181	33	64	3
3.1	0.1220	36	68	4
3.2	0.1260	36	68	4
3.3	0.1299	36	68	4
3.4	0.1339	39	71	4
3.5	0.1378	39	71	4
3.6	0.1417	39	71	4
3.7	0.1457	39	71	4
3.8	0.1496	43	75	4
3.9	0.1535	43	75	4
4.0	0.1575	43	75	4
4.1	0.1614	43	85	6
4.2	0.1654	43	85	6
4.3	0.1693	47	89	6
4.4	0.1732	47	89	6
4.5	0.1772	47	89	6
4.6	0.1811	47	89	6
4.7	0.1850	47	89	6
4.8	0.1890	52	94	6
4.9	0.1929	52	94	6
5.0	0.1969	52	94	6
5.1	0.2008	52	94	6
5.2	0.2047	52	94	6
5.3	0.2087	52	94	6
5.4	0.2126	57	99	6
5.5	0.2165	57	99	6
5.6	0.2205	57	99	6
5.7	0.2244	57	99	6
5.8	0.2283	57	99	6
5.9	0.2323	57	99	6
6.0	0.2362	57	99	6
6.1	0.2402	63	107	8

Size	Decimal Equivalent	Flute Length	Overall Length	Shank Dia.
6.2	0.2441	63	107	8
6.3	0.2480	63	107	8
6.4	0.2520	63	107	8
6.5	0.2559	63	107	8
6.6	0.2598	63	107	8
6.7	0.2638	63	107	8
6.8	0.2677	69	113	8
6.9	0.2717	69	113	8
7.0	0.2756	69	113	8
7.1	0.2795	69	113	8
7.2	0.2835	69	113	8
7.3	0.2874	69	113	8
7.4	0.2913	69	113	8
7.5	0.2953	69	113	8
7.6	0.2992	75	119	8
7.7	0.3031	75	119	8
7.8	0.3071	75	119	8
7.9	0.3110	75	119	8
8.0	0.3150	75	119	8
8.1	0.3189	75	125	10
8.2	0.3228	75	125	10
8.3	0.3268	75	125	10
8.4	0.3307	75	125	10
8.5	0.3346	75	125	10
8.6	0.3386	81	131	10
8.7	0.3425	81	131	10
8.8	0.3465	81	131	10
8.9	0.3504	81	131	10
9.0	0.3543	81	131	10
9.1	0.3583	81	131	10
9.2	0.3622	81	131	10
9.3	0.3661	81	131	10
9.4	0.3701	81	131	10
9.5	0.3740	81	131	10
9.6	0.3780	87	137	10
9.7	0.3819	87	137	10
9.8	0.3858	87	137	10
9.9	0.3898	87	137	10
10.0	0.3937	87	137	10
10.1	0.3976	87	144	12
10.1	0.3976	87	144	12
10.2	0.4016	87	144	12

Size	Decimal Equivalent	Flute Length	Overall Length	Shank Dia.
10.3	0.4055	87	144	12
10.4	0.4094	87	144	12
10.5	0.4134	87	144	12
10.6	0.4173	87	144	12
10.7	0.4213	94	151	12
10.8	0.4252	94	151	12
10.9	0.4291	94	151	12
11.0	0.4331	94	151	12
11.1	0.4370	94	151	12
11.2	0.4409	94	151	12
11.3	0.4449	94	151	12
11.4	0.4488	94	151	12
11.5	0.4528	94	151	12
11.6	0.4567	94	151	12
11.7	0.4606	94	151	12
11.8	0.4646	94	151	12
11.9	0.4685	101	158	12
12.0	0.4724	101	158	12
12.1	0.4764	101	158	12
12.2	0.4803	101	158	12
12.3	0.4843	101	158	12
12.4	0.4882	101	158	12
12.5	0.4921	101	158	12
12.6	0.4961	101	158	12
12.7	0.5000	101	158	12
12.8	0.5039	101	158	12
12.9	0.5079	101	158	12
13.0	0.5118	101	158	12
13.5	0.5315	108	168	16
14.0	0.5512	108	168	16
14.5	0.5709	114	173	16
15.0	0.5906	114	180	20
15.5	0.6102	120	185	20
16.0	0.6299	120	185	20
16.5	0.6496	125	189	20
17.0	0.6693	125	189	20
17.5	0.6890	130	194	20
18.0	0.7087	130	194	20
18.5	0.7283	135	198	20
19.0	0.7480	135	206	25
19.5	0.7677	140	210	25
20.0	0.7874	140	210	25

Not recommended for Austenite type of stainless steel

1 per tube

Technical Data

DRILLS

DRILLS
Cutting Condition

END MILLS

END MILLS
Cutting Condition

TAPS

TAPS
Cutting Condition

Others

List No.7571P High Performance

PM-HSS SG COATED



Range 3/32 to 3/4



Jobber length drill provides stable high-speed drilling and long tool life in a variety of materials; not suitable for Austenitic Stainless Steel.

Size	Decimal Equivalent	Metric Equivalent	Flute Length	Overall Length	Shank Dia.	
						Fractional
#45	0.0820	2.08	1 1/8	2 3/8	1/8	
#44	0.0860	2.18	1 1/8	2 3/8	1/8	
#43	0.0890	2.26	1 1/4	2 1/2	1/8	
#42	0.0935	2.37	1 1/4	2 1/2	1/8	
3/32	0.0938	2.38	1 1/8	2 3/8	1/8	
	#41	0.0960	2.44	1 3/8	2 5/8	1/8
	#40	0.0980	2.49	1 3/8	2 5/8	1/8
	#39	0.0995	2.53	1 3/8	2 13/16	1/8
	#38	0.1015	2.58	1 7/16	2 7/8	1/8
7/64	#37	0.1040	2.64	1 7/16	2 7/8	1/8
	#36	0.1065	2.71	1 7/16	2 7/8	1/8
		0.1094	2.78	1 1/4	2 1/2	1/8
	#34	0.1110	2.82	1 1/2	2 15/16	1/8
	#33	0.1130	2.87	1 1/2	2 15/16	1/8
1/8		0.1250	3.18	1 3/8	2 5/8	1/8
	#30	0.1285	3.26	1 5/8	3 1/16	3/16
	#29	0.1365	3.47	1 3/4	3 3/16	3/16
	#28	0.1405	3.57	1 3/4	3 3/16	3/16
9/64		0.1406	3.57	1 1/2	2 7/8	3/16
	#27	0.1440	3.66	1 7/8	3 5/16	3/16
	#26	0.1470	3.73	1 7/8	3 5/16	3/16
	#25	0.1495	3.80	1 7/8	3 5/16	3/16
	#24	0.1520	3.86	2	3 7/16	3/16
5/32	#23	0.1540	3.91	2	3 7/16	3/16
		0.1563	3.97	1 3/4	3 1/8	3/16
	#22	0.1570	3.99	2	3 7/16	3/16
	#21	0.1590	4.04	2 1/8	3 9/16	3/16
	#20	0.1610	4.09	2 1/8	3 9/16	3/16
11/64	#19	0.1660	4.22	2 1/8	3 9/16	3/16
		0.1719	4.37	1 7/8	3 1/4	3/16
	#15	0.1800	4.57	2 3/16	3 5/8	3/16
	#14	0.1820	4.62	2 3/16	3 5/8	3/16
3/16		0.1875	4.76	2	3 3/8	3/16
	#10	0.1935	4.91	2 7/16	4 1/4	1/4
	#9	0.1960	4.98	2 7/16	4 1/4	1/4
13/64	#8	0.1990	5.05	2 7/16	4 1/4	1/4
	#7	0.2010	5.11	2 7/16	4 1/4	1/4
		0.2031	5.16	2 1/16	3 7/8	1/4
	#6	0.2040	5.18	2 7/16	4 1/4	1/4
	#5	0.2055	5.22	2 1/2	4 5/16	1/4
7/32	#4	0.2090	5.31	2 1/2	4 5/16	1/4
	#3	0.2130	5.41	2 1/2	4 5/16	1/4
		0.2188	5.56	2 1/16	3 7/8	1/4
	#2	0.2210	5.61	2 5/8	4 7/16	1/4
#1	0.2280	5.79	2 5/8	4 7/16	1/4	

Size	Decimal Equivalent	Metric Equivalent	Flute Length	Overall Length	Shank Dia.	
						Fractional
15/64		0.2344	5.95	2 3/8	4 1/4	1/4
	B	0.2380	6.05	2 3/4	4 9/16	1/4
	C	0.2420	6.15	2 3/4	4 9/16	1/4
	D	0.2460	6.25	2 3/4	4 9/16	1/4
1/4		0.2500	6.35	2 3/8	4 1/4	1/4
	F	0.2570	6.53	2 7/8	4 11/16	3/8
	G	0.2610	6.63	2 7/8	4 11/16	3/8
17/64		0.2656	6.75	2 3/4	4 5/8	3/8
	I	0.2720	6.91	2 7/8	4 11/16	3/8
	J	0.2770	7.04	2 7/8	4 11/16	3/8
9/32		0.2813	7.14	2 3/4	4 5/8	3/8
	L	0.2900	7.37	2 15/16	4 3/4	3/8
19/64	M	0.2950	7.49	3 1/16	4 7/8	3/8
		0.2969	7.54	2 7/8	4 3/4	3/8
5/16	N	0.3020	7.67	3 1/16	4 7/8	3/8
		0.3125	7.94	2 7/8	4 3/4	3/8
21/64	O	0.3160	8.03	3 3/16	5	3/8
		0.3281	8.33	2 7/8	4 3/4	3/8
	Q	0.3320	8.43	3 7/16	5 1/4	3/8
	R	0.3390	8.61	3 7/16	5 1/4	3/8
11/32		0.3438	8.73	3 1/4	5 1/8	3/8
23/64		0.3594	9.13	3 1/4	5 1/8	3/8
3/8	U	0.3680	9.35	3 5/8	5 7/16	3/8
		0.3750	9.53	3 1/4	5 1/8	3/8
25/64	V	0.3770	9.58	3 5/8	5 23/32	1/2
		0.3906	9.92	3 3/8	5 1/2	1/2
	X	0.3970	10.08	3 3/4	5 27/32	1/2
	Y	0.4040	10.26	3 7/8	5 31/32	1/2
13/32		0.4063	10.32	3 3/8	5 1/2	1/2
	Z	0.4130	10.49	3 7/8	5 31/32	1/2
27/64		0.4219	10.72	3 3/4	5 7/8	1/2
7/16		0.4375	11.11	3 3/4	5 7/8	1/2
29/64		0.4531	11.51	3 3/4	5 7/8	1/2
15/32		0.4688	11.91	4	6 1/4	1/2
31/64		0.4844	12.30	4	6 1/4	1/2
1/2		0.5000	12.70	4	6 1/4	1/2
17/32		0.5313	13.49	4 1/4	6 3/4	5/8
9/16		0.5625	14.29	4 1/2	7	5/8
37/64		0.5781	14.68	4 1/2	7	5/8
19/32		0.5938	15.08	4 3/4	7 1/4	3/4
5/8		0.6250	15.88	4 3/4	7 1/4	3/4
21/32		0.6563	16.67	5	7 1/2	3/4
11/16		0.6875	17.46	5 1/8	7 5/8	3/4
23/32		0.7188	18.26	5 3/8	7 3/4	7/8
3/4		0.7500	19.05	5 1/2	7 7/8	7/8

Not recommended for Austenite type of stainless steel

1 per tube

Technical Data

DRILLS

DRILLS Cutting Condition

END MILLS

END MILLS Cutting Condition

TAPS

TAPS Cutting Condition

Others

**SG DRILLS WITH OIL-HOLES / METRIC SIZES
FRACTIONAL SIZES**

List No.7596P Metric Sizes

List No.7591P Fractional



L7596P Range 5.0 to 20.0
L7591P Range 15/64 to 3/4

PM-HSS SG COATED



This oil hole drill is suitable for high-speed and long life drilling, and adapted in workpiece material from Carbon Steels and Stainless Steels to Aluminum.

L7596P

(Unit) : mm

L7591P

Size	Decimal Equivalent	Flute Length	Overall Length
5.0	0.1969	52	94
5.5	0.2165	57	99
6.0	0.2362	57	99
6.5	0.2559	63	107
7.0	0.2756	69	113
7.5	0.2953	69	113
8.0	0.3150	75	119
8.5	0.3346	75	125
9.0	0.3543	81	131
9.5	0.3740	81	131
10.0	0.3937	87	137
10.5	0.4134	87	144
11.0	0.4331	94	151
11.5	0.4528	94	151
12.0	0.4724	101	158
12.5	0.4921	101	158
13.0	0.5118	101	158
13.5	0.5315	108	168
14.0	0.5512	108	168
14.5	0.5709	114	173
15.0	0.5906	114	180
15.5	0.6102	120	185
16.0	0.6299	120	185
16.5	0.6496	125	189
17.0	0.6693	125	189
17.5	0.6890	130	194
18.0	0.7087	130	194
18.5	0.7283	135	198
19.0	0.7480	135	206
19.5	0.7677	140	210
20.0	0.7874	140	210

Size	Decimal Equivalent	Flute Length	Overall Length
15/64	0.2344	2-3/8	4-1/4
1/4	0.2500	2-3/8	4-1/4
17/64	0.2656	2-3/4	4-5/8
9/32	0.2813	2-3/4	4-5/8
19/64	0.2969	2-7/8	4-3/4
5/16	0.3125	2-7/8	4-3/4
21/64	0.3281	2-7/8	4-3/4
11/32	0.3438	3-1/4	5-1/8
23/64	0.3594	3-1/4	5-1/8
3/8	0.3750	3-1/4	5-1/8
25/64	0.3906	3-3/8	5-1/2
13/32	0.4063	3-3/8	5-1/2
27/64	0.4219	3-3/4	5-7/8
7/16	0.4375	3-3/4	5-7/8
29/64	0.4531	3-3/4	5-7/8
15/32	0.4688	4	6-1/4
31/64	0.4844	4	6-1/4
1/2	0.5000	4	6-1/4
17/32	0.5313	4-1/4	6-3/4
9/16	0.5625	4-1/2	7
37/64	0.5781	4-1/2	7
19/32	0.5938	4-3/4	7-1/4
5/8	0.6250	4-3/4	7-1/4
21/32	0.6563	5	7-1/2
11/16	0.6875	5-1/8	7-5/8
23/32	0.7188	5-3/8	7-3/4
3/4	0.7500	5-1/2	7-7/8

1 per tube

Technical Data

DRILLS

DRILLS
Cutting Condition

END MILLS

END MILLS
Cutting Condition

TAPS

TAPS
Cutting Condition

Others

List No.6517U High Performance**HSS-Co UG COATED**

Range 3/64 to 1/2



This drill is designed for deep hole drilling Flute geometry allows for easy chip removal and can be drilled up to 7 times of drill diameter without pecking.

Size	Decimal Equivalent	Flute Length	Overall Length
3/64	0.0469	3/4	1 3/4
1/16	0.0625	7/8	1 7/8
5/64	0.0781	1	2
3/32	0.0938	1 1/4	2 1/4
7/64	0.1094	1 1/2	2 5/8
1/8	0.1250	1 5/8	2 3/4
9/64	0.1406	1 3/4	2 7/8
5/32	0.1563	2	3 1/8
11/64	0.1719	2 1/8	3 1/4
3/16	0.1875	2 5/16	3 1/2
13/64	0.2031	2 7/16	3 5/8
7/32	0.2188	2 1/2	3 3/4
15/64	0.2344	2 5/8	3 7/8
1/4	0.2500	2 3/4	4
17/64	0.2656	2 7/8	4 1/8
9/32	0.2813	2 15/16	4 1/4
19/64	0.2969	3 1/16	4 3/8
5/16	0.3125	3 3/16	4 1/2
21/64	0.3281	3 5/16	4 5/8
11/32	0.3438	3 7/16	4 3/4
23/64	0.3594	3 1/2	4 7/8
3/8	0.3750	3 5/8	5
25/64	0.3906	3 3/4	5 1/8
13/32	0.4063	3 7/8	5 1/4
27/64	0.4219	3 15/16	5 3/8
7/16	0.4375	4 1/16	5 1/2
29/64	0.4531	4 3/16	5 5/8
15/32	0.4688	4 5/16	5 3/4
31/64	0.4844	4 3/8	5 7/8
1/2	0.5000	4 1/2	6

"UG" Coating is NACHI's Special Multi-Layered TiCN Coating

3/64 to 5/64 in package of 10, 3/32 to 1/2 1 per tube

"UG" Power Drills is suitable for 7D Non-Step Drilling

Technical Data

DRILLS

DRILLS
Cutting Condition

END MILLS

END MILLS
Cutting Condition

TAPS

TAPS
Cutting Condition

Others

List No.6528P High Performance



Range 1.0 to 13.0

HSS-Co UG COATED



This drill can proceed non-step drilling deeply up to 7 times of drill diameter.

(Unit) : mm

Size	Decimal Equivalent	Flute Length	Overall Length
1.0	0.0394	12	34
1.1	0.0433	14	36
1.2	0.0472	16	38
1.3	0.0512	16	38
1.4	0.0551	18	40
1.5	0.0591	18	40
1.6	0.0630	20	43
1.7	0.0669	20	43
1.8	0.0709	22	46
1.9	0.0748	22	46
2.0	0.0787	24	49
2.1	0.0827	24	49
2.2	0.0866	27	53
2.3	0.0906	27	53
2.4	0.0945	30	57
2.5	0.0984	30	57
2.6	0.1024	30	57
2.7	0.1063	33	61
2.8	0.1102	33	61
2.9	0.1142	33	61
3.0	0.1181	33	61
3.1	0.1220	36	65
3.2	0.1260	36	65
3.3	0.1299	36	65
3.4	0.1339	39	70
3.5	0.1378	39	70
3.6	0.1417	39	70
3.7	0.1457	39	70
3.8	0.1496	43	75
3.9	0.1535	43	75
4.0	0.1575	43	75
4.1	0.1614	43	75
4.2	0.1654	43	75
4.3	0.1693	47	80
4.4	0.1732	47	80
4.5	0.1772	47	80
4.6	0.1811	47	80
4.7	0.1850	47	80
4.8	0.1890	52	86
4.9	0.1929	52	86
5.0	0.1969	52	86
5.1	0.2008	52	86
5.2	0.2047	52	86
5.3	0.2087	52	86
5.4	0.2126	57	93
5.5	0.2165	57	93
5.6	0.2205	57	93
5.7	0.2244	57	93
5.8	0.2283	57	93
5.9	0.2323	57	93
6.0	0.2362	57	93
6.1	0.2402	63	101
6.2	0.2441	63	101
6.3	0.2480	63	101
6.4	0.2520	63	101
6.5	0.2559	63	101
6.6	0.2598	63	101
6.7	0.2638	63	101
6.8	0.2677	69	109
6.9	0.2717	69	109
7.0	0.2756	69	109

1.0 to 1.9 in package of 10, 2.0 to 13.0 1 per tube

Size	Decimal Equivalent	Flute Length	Overall Length
7.1	0.2795	69	109
7.2	0.2835	69	109
7.3	0.2874	69	109
7.4	0.2913	69	109
7.5	0.2953	69	109
7.6	0.2992	75	117
7.7	0.3031	75	117
7.8	0.3071	75	117
7.9	0.3110	75	117
8.0	0.3150	75	117
8.1	0.3189	75	117
8.2	0.3228	75	117
8.3	0.3268	75	117
8.4	0.3307	75	117
8.5	0.3346	75	117
8.6	0.3386	81	125
8.7	0.3425	81	125
8.8	0.3465	81	125
8.9	0.3504	81	125
9.0	0.3543	81	125
9.1	0.3583	81	125
9.2	0.3622	81	125
9.3	0.3661	81	125
9.4	0.3701	81	125
9.5	0.3740	81	125
9.6	0.3780	87	133
9.7	0.3819	87	133
9.8	0.3858	87	133
9.9	0.3898	87	133
10.0	0.3937	87	133
10.1	0.3976	87	133
10.2	0.4016	87	133
10.3	0.4055	87	133
10.4	0.4094	87	133
10.5	0.4134	87	133
10.6	0.4173	87	133
10.7	0.4213	94	142
10.8	0.4252	94	142
10.9	0.4291	94	142
11.0	0.4331	94	142
11.1	0.4370	94	142
11.2	0.4409	94	142
11.3	0.4449	94	142
11.4	0.4488	94	142
11.5	0.4528	94	142
11.6	0.4567	94	142
11.7	0.4606	94	142
11.8	0.4646	94	142
11.9	0.4685	101	151
12.0	0.4724	101	151
12.1	0.4764	101	151
12.2	0.4803	101	151
12.3	0.4843	101	151
12.4	0.4882	101	151
12.5	0.4921	101	151
12.6	0.4961	101	151
12.7	0.5000	101	151
12.8	0.5039	101	151
12.9	0.5079	101	151
13.0	0.5118	101	151

* JAPAN STOCK ITEM : Please allow 2-3 weeks delivery

Technical Data

DRILLS

DRILLS Cutting Condition

END MILLS

END MILLS Cutting Condition

TAPS

TAPS Cutting Condition

Others

AG-SUS DRILLS SHORT / METRIC SIZES

List No.6596P

High Performance

FM HSS AG COATED



Range 1.0 to 20.0

This drill meets stable drilling by AG coat, and is very suitable for drilling of Stainless Steel.

(Unit) : mm

Size	Flute Length	Overall Length	Shank Dia.
1.0	6	40	3
1.1	7	40	3
1.2	8	40	3
1.3	8	40	3
1.4	9	40	3
1.5	9	40	3
1.6	10	44	3
1.7	10	44	3
1.8	11	44	3
1.9	11	44	3
2.0	12	44	3
2.1	12	44	3
2.2	13	44	3
2.3	13	44	3
2.4	14	48	3
2.5	14	48	3
2.6	14	48	3
2.7	16	48	3
2.8	16	48	3
2.9	16	48	3
3.0	16	48	3
3.1	18	54	4
3.2	18	54	4
3.3	18	54	4
3.4	20	54	4
3.5	20	54	4
3.6	20	54	4
3.7	20	54	4
3.8	22	54	4
3.9	22	54	4
4.0	22	54	4
4.1	22	66	6
4.2	22	66	6
4.3	24	68	6
4.4	24	68	6
4.5	24	68	6
4.6	24	68	6
4.7	24	68	6
4.8	26	70	6
4.9	26	70	6
5.0	26	70	6
5.1	26	70	6
5.2	26	70	6
5.3	26	70	6
5.4	28	72	6

Size	Flute Length	Overall Length	Shank Dia.
5.5	28	72	6
5.6	28	72	6
5.7	28	72	6
5.8	28	72	6
5.9	28	72	6
6.0	28	72	6
6.1	31	75	8
6.2	31	75	8
6.3	31	75	8
6.4	31	75	8
6.5	31	75	8
6.6	31	75	8
6.7	31	75	8
6.8	34	78	8
6.9	34	78	8
7.0	34	78	8
7.1	34	78	8
7.2	34	78	8
7.3	34	78	8
7.4	34	78	8
7.5	34	78	8
7.6	37	81	8
7.7	37	81	8
7.8	37	81	8
7.9	37	81	8
8.0	37	81	8
8.1	37	87	10
8.2	37	87	10
8.3	37	87	10
8.4	37	87	10
8.5	37	87	10
8.6	40	90	10
8.7	40	90	10
8.8	40	90	10
8.9	40	90	10
9.0	40	90	10
9.1	40	90	10
9.2	40	90	10
9.3	40	90	10
9.4	40	90	10
9.5	40	90	10
9.6	43	93	10
9.7	43	93	10
9.8	43	93	10
9.9	43	93	10

Size	Flute Length	Overall Length	Shank Dia.
10.0	43	93	10
10.1	43	100	12
10.2	43	100	12
10.3	43	100	12
10.4	43	100	12
10.5	43	100	12
10.6	43	100	12
10.7	47	104	12
10.8	47	104	12
10.9	47	104	12
11.0	47	104	12
11.1	47	104	12
11.2	47	104	12
11.3	47	104	12
11.4	47	104	12
11.5	47	104	12
11.6	47	104	12
11.7	47	104	12
11.8	47	104	12
11.9	51	108	12
12.0	51	108	12
12.1	51	108	12
12.2	51	108	12
12.3	51	108	12
12.4	51	108	12
12.5	51	108	12
12.6	51	108	12
12.7	51	108	12
12.8	51	108	12
12.9	51	108	12
13.0	51	108	12
13.5	72	132	16
14.0	72	132	16
14.5	76	136	16
15.0	76	142	20
15.5	80	146	20
16.0	80	146	20
16.5	84	150	20
17.0	84	150	20
17.5	87	153	20
18.0	87	153	20
18.5	90	156	20
19.0	90	164	25
19.5	94	168	25
20.0	94	168	25

1 per tube

Technical Data

DRILLS

DRILLS Cutting Condition

END MILLS

END MILLS Cutting Condition

TAPS

TAPS Cutting Condition

Others

AG-SUS DRILLS REGULAR / METRIC SIZES

List No.6594P High Performance

FM HSS AG COATED



Range 2.0 to 20.0



This drill meets stable drilling by AG coat, and is very suitable for drilling of Stainless Steel.

(Unit) : mm

Size	Decimal Equivalent	Flute Length	Overall Length	Shank Diameter
1.0	0.0394	12	50	3
1.1	0.0433	14	50	3
1.2	0.0472	16	50	3
1.3	0.0512	16	50	3
1.4	0.0551	18	50	3
1.5	0.0591	18	50	3
1.6	0.0630	20	56	3
1.7	0.0669	20	56	3
1.8	0.0709	22	56	3
1.9	0.0748	22	56	3
2.0	0.0787	24	56	3
2.1	0.0827	24	56	3
2.2	0.0866	25	56	3
2.3	0.0906	25	56	3
2.4	0.0945	30	61	3
2.5	0.0984	30	61	3
2.6	0.1024	30	61	3
2.7	0.1063	33	64	3
2.8	0.1102	33	64	3
2.9	0.1142	33	64	3
3.0	0.1181	33	64	3
3.1	0.1220	36	71	4
3.2	0.1260	36	71	4
3.3	0.1299	36	71	4
3.4	0.1339	39	71	4
3.5	0.1378	39	71	4
3.6	0.1417	39	71	4
3.7	0.1457	39	71	4
3.8	0.1496	43	75	4
3.9	0.1535	43	75	4
4.0	0.1575	43	75	4
4.1	0.1614	43	85	6
4.2	0.1654	43	85	6
4.3	0.1693	47	89	6
4.4	0.1732	47	89	6
4.5	0.1772	47	89	6
4.6	0.1811	47	89	6
4.7	0.1850	47	89	6
4.8	0.1890	52	94	6
4.9	0.1929	52	94	6
5.0	0.1969	52	94	6
5.1	0.2008	52	94	6
5.2	0.2047	52	94	6
5.3	0.2087	52	94	6
5.4	0.2126	57	99	6

Size	Decimal Equivalent	Flute Length	Overall Length	Shank Diameter
5.5	0.2165	57	99	6
5.6	0.2205	57	99	6
5.7	0.2244	57	99	6
5.8	0.2283	57	99	6
5.9	0.2323	57	99	6
6.0	0.2362	57	99	6
6.1	0.2402	63	107	8
6.2	0.2441	63	107	8
6.3	0.2480	63	107	8
6.4	0.2520	63	107	8
6.5	0.2559	63	107	8
6.6	0.2598	63	107	8
6.7	0.2638	63	107	8
6.8	0.2677	69	113	8
6.9	0.2717	69	113	8
7.0	0.2756	69	113	8
7.1	0.2795	69	113	8
7.2	0.2835	69	113	8
7.3	0.2874	69	113	8
7.4	0.2913	69	113	8
7.5	0.2953	69	113	8
7.6	0.2992	75	119	8
7.7	0.3031	75	119	8
7.8	0.3071	75	119	8
7.9	0.3110	75	119	8
8.0	0.3150	75	119	8
8.1	0.3189	75	125	10
8.2	0.3228	75	125	10
8.3	0.3268	75	125	10
8.4	0.3307	75	125	10
8.5	0.3346	75	125	10
8.6	0.3386	81	131	10
8.7	0.3425	81	131	10
8.8	0.3465	81	131	10
8.9	0.3504	81	131	10
9.0	0.3543	81	131	10
9.1	0.3583	81	131	10
9.2	0.3622	81	131	10
9.3	0.3661	81	131	10
9.4	0.3701	81	131	10
9.5	0.3740	81	131	10
9.6	0.3780	87	137	10
9.7	0.3819	87	137	10
9.8	0.3858	87	137	10
9.9	0.3898	87	137	10

Size	Decimal Equivalent	Flute Length	Overall Length	Shank Diameter
10.0	0.3937	87	137	10
10.1	0.3976	87	144	12
10.2	0.4016	87	144	12
10.3	0.4055	87	144	12
10.4	0.4094	87	144	12
10.5	0.4134	87	144	12
10.6	0.4173	87	144	12
10.7	0.4213	94	151	12
10.8	0.4252	94	151	12
10.9	0.4291	94	151	12
11.0	0.4331	94	151	12
11.1	0.4370	94	151	12
11.2	0.4409	94	151	12
11.3	0.4449	94	151	12
11.4	0.4488	94	151	12
11.5	0.4528	94	151	12
11.6	0.4567	94	151	12
11.7	0.4606	94	151	12
11.8	0.4646	94	151	12
11.9	0.4685	101	158	12
12.0	0.4724	101	158	12
12.1	0.4764	101	158	12
12.2	0.4803	101	158	12
12.3	0.4843	101	158	12
12.4	0.4882	101	158	12
12.5	0.4921	101	158	12
12.6	0.4961	101	158	12
12.7	0.5000	101	158	12
12.8	0.5039	101	158	12
12.9	0.5079	101	158	12
13.0	0.5118	101	158	12
13.5	0.5315	108	168	16
14.0	0.5512	108	168	16
14.5	0.5709	114	173	16
15.0	0.5906	114	180	20
15.5	0.6102	120	185	20
16.0	0.6299	120	185	20
16.5	0.6496	125	189	20
17.0	0.6693	125	189	20
17.5	0.6890	130	194	20
18.0	0.7087	130	194	20
18.5	0.7283	135	198	20
19.0	0.7480	135	206	25
19.5	0.7677	140	210	25
20.0	0.7874	140	210	25

1 per tube

Technical Data

DRILLS

DRILLS Cutting Condition

END MILLS

END MILLS Cutting Condition

TAPS

TAPS Cutting Condition

Others

List No.6595P High Performance

FM HSS AG COATED



Range 3/32 to 3/4



This drill meets stable drilling by AG coat, and is very suitable for drilling of Stainless Steel.

DIAMETER	DECIMAL EQUIVALENT	FLUTE LENGTH	OVERALL LENGTH	SHANK DIAMETER
3/32	0.0938	1-1/8	2-3/8	1/8
7/64	0.1094	1-1/4	2-1/2	1/8
1/8	0.1250	1-3/8	2-5/8	1/8
9/64	0.1406	1-1/2	2-7/8	3/16
5/32	0.1563	1-3/4	3-1/8	3/16
11/64	0.1719	1-7/8	3-1/4	3/16
3/16	0.1875	2	3-3/8	3/16
13/64	0.2031	2-1/16	3-7/8	1/4
7/32	0.2188	2-1/16	3-7/8	1/4
15/64	0.2344	2-3/8	4-1/4	1/4
1/4	0.2500	2-3/8	4-1/4	1/4
17/64	0.2656	2-3/4	4-5/8	3/8
9/32	0.2813	2-3/4	4-5/8	3/8
19/64	0.2969	2-7/8	4-3/4	3/8
5/16	0.3125	2-7/8	4-3/4	3/8
21/64	0.3281	2-7/8	4-3/4	3/8
11/32	0.3438	3-1/4	5-1/8	3/8
23/64	0.3594	3-1/4	5-1/8	3/8
3/8	0.3750	3-1/4	5-1/8	3/8
25/64	0.3906	3-3/8	5-1/2	1/2
13/32	0.4063	3-3/8	5-1/2	1/2
27/64	0.4219	3-3/4	5-7/8	1/2
7/16	0.4375	3-3/4	5-7/8	1/2
29/64	0.4531	3-3/4	5-7/8	1/2
15/32	0.4688	4	6-1/4	1/2
31/64	0.4844	4	6-1/4	1/2
1/2	0.5000	4	6-1/4	1/2
17/32	0.5313	4-1/4	6-3/4	5/8
9/16	0.5625	4-1/2	7	5/8
37/64	0.5781	4-1/2	7	5/8
19/32	0.5938	4-3/4	7-1/4	3/4
5/8	0.6250	4-3/4	7-1/4	3/4
21/32	0.6563	5	7-1/2	3/4
11/16	0.6875	5-1/8	7-5/8	3/4
23/32	0.7188	5-3/8	7-3/4	7/8
3/4	0.7500	5-1/2	7-7/8	7/8

1 per tube

Technical
Data

DRILLS

DRILLS
Cutting Condition

END MILLS

END MILLS
Cutting Condition

TAPS

TAPS
Cutting Condition

Others

List No.6540P Metric Sizes

List No.6541P Fractional



Series 1 Range 1.0 to 13.0
Series 2 Range 1.0 to 10.0
Series 3 Range 3.0 to 10.0

HSS-Co AG COATED



This drill meets non-step drilling of deep holes up to 20 times of a diameter, and is used for workpiece materials from raw materials to Mold Die Steels.

Note : Pre-hole should be drilled.

Series 1

(Unit) : mm

Size		Decimal Equivalent	Flute Length	Overall Length
Fractional L6541P	Metric L6540P			
	1.0	0.0394	33	56
	1.1	0.0433	37	60
	1.2	0.0472	41	65
	1.3	0.0512	41	65
	1.4	0.0551	45	70
	1.5	0.0591	45	70
	1.6	0.0630	50	76
	1.7	0.0669	50	76
	1.8	0.0709	53	80
	1.9	0.0748	53	80
	2.0	0.0787	56	85
	2.1	0.0827	56	85
	2.2	0.0866	59	90
	2.3	0.0906	59	90
	2.4	0.0945	62	95
	2.5	0.0984	62	95
	2.6	0.1024	62	95
	2.7	0.1063	66	100
	2.8	0.1102	66	100
	2.9	0.1142	66	100
	3.0	0.1181	66	100
	3.1	0.1220	69	106
1/8	3.175	0.1250	69	106
	3.2	0.1260	69	106
	3.3	0.1299	69	106
	3.4	0.1339	73	112
	3.5	0.1378	73	112
9/64	3.572	0.1406	73	112
	3.6	0.1417	73	112
	3.7	0.1457	73	112
	3.8	0.1496	78	119
	3.9	0.1535	78	119
5/32	3.969	0.1563	78	119
	4.0	0.1575	78	119
	4.1	0.1614	78	119
	4.2	0.1654	78	119
	4.3	0.1693	82	126
11/64	4.366	0.1719	82	126
	4.4	0.1732	82	126
	4.5	0.1772	82	126
	4.6	0.1811	82	126

Size		Decimal Equivalent	Flute Length	Overall Length
Fractional L6541P	Metric L6540P			
	4.7	0.1850	82	126
3/16	4.762	0.1875	87	132
	4.8	0.1890	87	132
	4.9	0.1929	87	132
	5.0	0.1969	87	132
	5.1	0.2008	87	132
13/64	5.159	0.2031	87	132
	5.2	0.2047	87	132
	5.3	0.2087	87	132
	5.4	0.2126	91	139
	5.5	0.2165	91	139
7/32	5.556	0.2187	91	139
	5.6	0.2205	91	139
	5.7	0.2244	91	139
	5.8	0.2283	91	139
	5.9	0.2323	91	139
	6.0	0.2362	91	139
1/4	6.35	0.2500	97	148
	6.5	0.2559	97	148
17/64	6.747	0.2656	102	156
	6.8	0.2677	102	156
	7.0	0.2756	102	156
9/32	7.144	0.2813	102	156
	7.5	0.2953	102	156
19/64	7.541	0.2969	109	165
5/16	7.933	0.3123	109	165
	8.0	0.3150	109	165
21/64	8.334	0.3281	109	165
	8.5	0.3346	109	165
11/32	8.731	0.3437	115	175
	9.0	0.3543	115	175
23/64	9.128	0.3594	115	175
	9.5	0.3740	115	175
3/8	9.525	0.3750	121	184
	10.0	0.3937	121	184
	10.5	0.4134	121	184
	11.0	0.4331	128	195
	11.5	0.4528	128	195
	12.0	0.4724	134	205
	12.5	0.4921	134	205
	13.0	0.5118	134	205

1 per tube

* METRIC SIZE is JAPAN STOCK ITEM : Please allow 2-3 weeks delivery

Technical Data

DRILLS

DRILLS
Cutting Condition

END MILLS

END MILLS
Cutting Condition

TAPS

TAPS
Cutting Condition

Others

AG-POWER LONG DRILLS / METRIC SIZES
FRACTIONAL SIZES

Technical Data

DRILLS

DRILLS Cutting Condition

END MILLS

END MILLS Cutting Condition

TAPS

TAPS Cutting Condition

Others



Series 2

(Unit) : mm

Size		Decimal Equivalent	Flute Length	Overall Length	
Fractional L6541P	Metric L6540P				
	1.0	0.0394	60	100	
	1.1	0.0433	60	100	
	1.2	0.0472	65	105	
	1.3	0.0512	65	105	
	1.4	0.0551	70	110	
	1.5	0.0591	70	110	
	1.6	0.0630	75	115	
	1.7	0.0669	75	115	
	1.8	0.0709	80	120	
	1.9	0.0748	80	120	
	2.0	0.0787	85	125	
	2.1	0.0827	85	125	
	2.2	0.0866	90	135	
	2.3	0.0906	90	135	
	2.4	0.0945	95	140	
	2.5	0.0984	95	140	
	2.6	0.1024	95	140	
	2.7	0.1063	100	150	
	2.8	0.1102	100	150	
	2.9	0.1142	100	150	
	3.0	0.1181	100	150	
	3.1	0.1220	105	155	
1/8	3.175	0.1250	105	155	
	3.2	0.1260	105	155	
	3.3	0.1299	105	155	
	3.4	0.1339	115	165	
	3.5	0.1378	115	165	
△	9/64	3.572	0.1406	115	165
	3.6	0.1417	115	165	
	3.7	0.1457	115	165	
	3.8	0.1496	120	175	
	3.9	0.1535	120	175	
△	5/32	3.969	0.1563	120	175
	4.0	0.1575	120	175	
	4.1	0.1614	120	175	
	4.2	0.1654	120	175	
	4.3	0.1693	125	185	
△	11/64	4.366	0.1719	125	185

Size		Decimal Equivalent	Flute Length	Overall Length	
Fractional L6541P	Metric L6540P				
	4.4	0.1732	125	185	
	4.5	0.1772	125	185	
	4.6	0.1811	125	185	
	4.7	0.1850	125	185	
3/16	4.762	0.1875	135	195	
	4.8	0.1890	135	195	
	4.9	0.1929	135	195	
	5.0	0.1969	135	195	
	5.1	0.2008	135	195	
△	13/64	5.159	0.2031	135	195
	5.2	0.2047	135	195	
	5.3	0.2087	135	195	
	5.4	0.2126	140	205	
△	7/32	5.556	0.2187	140	205
	5.6	0.2205	140	205	
	5.7	0.2244	140	205	
	5.8	0.2283	140	205	
	5.9	0.2323	140	205	
	6.0	0.2362	140	205	
1/4	6.35	0.2500	150	215	
	6.5	0.2559	150	215	
△	17/64	6.747	0.2656	155	225
	6.8	0.2677	155	225	
	7.0	0.2756	155	225	
9/32	7.144	0.2813	155	225	
	7.5	0.2953	155	225	
△	19/64	7.541	0.2969	165	240
5/16	7.933	0.3123	165	240	
	8.0	0.3150	165	240	
21/64	8.334	0.3281	165	240	
	8.5	0.3346	165	240	
11/32	8.731	0.3437	175	250	
	9.0	0.3543	175	250	
23/64	9.128	0.3594	175	250	
	9.5	0.3740	175	250	
△	3/8	9.525	0.3750	185	265
	10.0	0.3937	185	265	



1 per tube

Series 3

(Unit) : mm

Size		Decimal Equivalent	Flute Length	Overall Length	
Fractional L6541P	Metric L6540P				
	3.0	0.1181	130	190	
1/8	3.175	0.1250	135	200	
	3.5	0.1378	145	210	
△	9/64	3.572	0.1406	145	210
△	5/32	3.969	0.1563	150	220
	4.0	0.1575	150	220	
△	11/64	4.366	0.1719	160	235
	4.5	0.1772	160	235	
3/16	4.762	0.1875	170	245	
	5.0	0.1969	170	245	
	5.5	0.2165	180	260	
△	7/32	5.556	0.2187	180	260

Size		Decimal Equivalent	Flute Length	Overall Length
Fractional L6541P	Metric L6540P			
	6.0	0.2362	180	260
1/4	6.35	0.2500	190	275
	6.5	0.2559	190	275
	7.0	0.2756	200	290
	7.5	0.2953	200	290
5/16	7.933	0.3123	210	305
	8.0	0.3150	210	305
	8.5	0.3346	210	305
	9.0	0.3543	220	320
	9.5	0.3740	220	320
	10.0	0.3937	235	340

• Other size manufactured upon request.

1 per tube

△ CUSTOM-MADE ITEM : Please choose nearest metric size. If it is not acceptable, please contact our office 1-888-340-8665.

List No.9550 High Performance



Range 3.0 to 20.0

SOLID CARBIDE AQUA COATED



This drill having stub length is suited for high-speed and long life drilling, and is useful in dry-process. This is suitable for most workpiece materials from raw material to hardened material.

(Unit) : mm

Size	Decimal Equivalent	Flute Length	Overall Length	Shank Dia.
3.0	0.1181	16	48	3
3.1	0.1220	18	50	4
3.2	0.1260	18	50	4
3.3	0.1299	18	50	4
3.4	0.1339	20	52	4
3.5	0.1378	20	52	4
3.6	0.1417	20	52	4
3.7	0.1457	20	52	4
3.8	0.1496	22	54	4
3.9	0.1535	22	54	4
4.0	0.1575	22	54	4
4.1	0.1614	22	66	6
4.2	0.1654	22	66	6
4.3	0.1693	24	68	6
4.4	0.1732	24	68	6
4.5	0.1772	24	68	6
4.6	0.1811	24	68	6
4.7	0.1850	24	68	6
4.8	0.1890	26	70	6
4.9	0.1929	26	70	6
5.0	0.1969	26	70	6
5.1	0.2008	26	70	6
5.2	0.2047	26	70	6
5.3	0.2087	26	70	6
5.4	0.2126	28	72	6
5.5	0.2165	28	72	6
5.6	0.2205	28	72	6
5.7	0.2244	28	72	6
5.8	0.2283	28	72	6
5.9	0.2323	28	72	6
6.0	0.2362	28	72	6
6.1	0.2402	31	75	8
6.2	0.2441	31	75	8
6.3	0.2480	31	75	8
6.4	0.2520	31	75	8
6.5	0.2559	31	75	8
6.6	0.2598	31	75	8
6.7	0.2638	31	75	8
6.8	0.2677	34	78	8
6.9	0.2717	34	78	8
7.0	0.2756	34	78	8
7.1	0.2795	34	78	8
7.2	0.2835	34	78	8
7.3	0.2874	34	78	8
7.4	0.2913	34	78	8
7.5	0.2953	34	78	8
7.6	0.2992	37	81	8
7.7	0.3031	37	81	8
7.8	0.3071	37	81	8
7.9	0.3110	37	81	8
8.0	0.3150	37	81	8
8.1	0.3189	37	87	10
8.2	0.3228	37	87	10
8.3	0.3268	37	87	10
8.4	0.3307	37	87	10
8.5	0.3346	37	87	10
8.6	0.3386	40	90	10
8.7	0.3425	40	90	10
8.8	0.3465	40	90	10

Size	Decimal Equivalent	Flute Length	Overall Length	Shank Dia.
8.9	0.3504	40	90	10
9.0	0.3543	40	90	10
9.1	0.3583	40	90	10
9.2	0.3622	40	90	10
9.3	0.3661	40	90	10
9.4	0.3701	40	90	10
9.5	0.3740	40	90	10
9.6	0.3780	43	93	10
9.7	0.3819	43	93	10
9.8	0.3858	43	93	10
9.9	0.3898	43	93	10
10.0	0.3937	43	93	10
10.1	0.3976	43	100	12
10.2	0.4016	43	100	12
10.3	0.4055	43	100	12
10.4	0.4094	43	100	12
10.5	0.4134	43	100	12
10.6	0.4173	43	100	12
10.7	0.4213	47	104	12
10.8	0.4252	47	104	12
10.9	0.4291	47	104	12
11.0	0.4331	47	104	12
11.1	0.4370	47	104	12
11.2	0.4409	47	104	12
11.3	0.4449	47	104	12
11.4	0.4488	47	104	12
11.5	0.4528	47	104	12
11.6	0.4567	47	104	12
11.7	0.4606	47	104	12
11.8	0.4646	47	104	12
11.9	0.4685	51	108	12
12.0	0.4724	51	108	12
12.1	0.4764	51	110	14
12.2	0.4803	51	110	14
12.3	0.4843	51	110	14
12.4	0.4882	51	110	14
12.5	0.4921	51	110	14
12.6	0.4961	51	110	14
12.7	0.5000	51	110	14
12.8	0.5039	51	110	14
12.9	0.5079	51	110	14
13.0	0.5118	51	110	14
13.5	0.5315	72	130	14
14.0	0.5512	72	130	14
14.1	0.5551	76	136	16
14.5	0.5709	76	136	16
14.6	0.5748	76	136	16
15.0	0.5906	76	136	16
15.5	0.6102	80	144	16
16.0	0.6299	80	144	16
16.5	0.6496	84	150	18
17.0	0.6693	84	150	18
17.5	0.6890	87	153	18
18.0	0.7087	87	153	18
18.5	0.7283	90	156	20
19.0	0.7480	90	156	20
19.5	0.7677	94	160	20
20.0	0.7874	94	160	20

1 per tube

* JAPAN STOCK ITEM : Please allow 2-3 weeks delivery

Technical Data

DRILLS

DRILLS Cutting Condition

END MILLS

END MILLS Cutting Condition

TAPS

TAPS Cutting Condition

Others

AQUA DRILLS STUB / FRACTIONAL SIZES

List No.9551 High Performance



Range 1/8 to 3/4

SOLID CARBIDE AQUA COATED

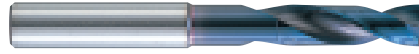

This drill having stub length is suited for high-speed and long life drilling, and is useful in dry-process. This is suitable for most workpiece materials from raw material to hardened material.

Size	Decimal Equivalent	Flute Length	Overall Length	Shank Dia.
1/8	0.1250	3/4	2	1/8
9/64	0.1406	13/16	2-1/8	3/16
5/32	0.1563	13/16	2-1/8	3/16
11/64	0.1719	1	2-3/8	3/16
3/16	0.1875	1	2-3/8	3/16
13/64	0.2031	1-1/8	2-7/8	1/4
7/32	0.2188	1-1/8	2-7/8	1/4
15/64	0.2344	1-1/4	3	1/4
1/4	0.2500	1-1/4	3	1/4
17/64	0.2656	1-3/8	3-3/16	3/8
9/32	0.2813	1-3/8	3-3/16	3/8
19/64	0.2969	1-3/8	3-3/16	3/8
5/16	0.3125	1-1/2	3-3/8	3/8
21/64	0.3281	1-1/2	3-3/8	3/8
11/32	0.3438	1-5/8	3-1/2	3/8
23/64	0.3594	1-5/8	3-1/2	3/8
3/8	0.3750	1-5/8	3-1/2	3/8
25/64	0.3906	1-11/16	3-7/8	1/2
13/32	0.4063	1-11/16	3-7/8	1/2
27/64	0.4219	1-7/8	4-1/8	1/2
7/16	0.4375	1-7/8	4-1/8	1/2
29/64	0.4531	1-7/8	4-1/8	1/2
15/32	0.4688	2	4-1/4	1/2
31/64	0.4844	2	4-1/4	1/2
1/2	0.5000	2	4-1/4	1/2
17/32	0.5313	2-7/8	5-3/16	5/8
9/16	0.5625	3	5-3/8	5/8
19/32	0.5938	3	5-5/8	3/4
5/8	0.6250	3-3/16	5-3/4	3/4
21/32	0.6563	3-3/8	5-15/16	3/4
11/16	0.6875	3-7/16	6	3/4
23/32	0.7188	3-7/16	6	7/8
3/4	0.7500	3-9/16	6-1/2	7/8

1 per tube

Technical
Data

DRILLS

DRILLS
Cutting Condition

END MILLS

END MILLS
Cutting Condition

TAPS

TAPS
Cutting Condition

Others

List No.9552 High Performance



Range 2.0 to 20.0

SOLID CARBIDE AQUA COATED



This drill having 5 times flute of drill diameter is suited for high-speed and long life drilling, and is useful in dry-process. This is suitable for most workpiece materials from raw material to hardened material.

(Unit) : mm

Size	Decimal Equivalent	Flute Length	Overall Length	Shank Dia.
2.0	0.0787	15	47	3
2.05	0.0807	15	47	3
2.1	0.0827	15	47	3
2.15	0.0846	16	48	3
2.2	0.0866	16	48	3
2.25	0.0886	16	48	3
2.3	0.0906	16	48	3
2.35	0.0925	16	48	3
2.4	0.0945	17	49	3
2.45	0.0965	17	49	3
2.5	0.0984	17	49	3
2.55	0.1004	17	49	3
2.6	0.1024	17	49	3
2.65	0.1043	17	49	3
2.7	0.1063	19	51	3
2.75	0.1083	19	51	3
2.8	0.1102	19	51	3
2.85	0.1122	19	51	3
2.9	0.1142	19	51	3
2.95	0.1161	19	51	3
3.0	0.1181	19	51	3
3.1	0.1220	21	53	4
3.2	0.1260	21	53	4
3.3	0.1299	21	53	4
3.4	0.1339	24	56	4
3.5	0.1378	24	56	4
3.6	0.1417	24	56	4
3.7	0.1457	24	56	4
3.8	0.1496	27	59	4
3.9	0.1535	27	59	4
4.0	0.1575	27	59	4
4.1	0.1614	27	71	6
4.2	0.1654	27	71	6
4.3	0.1693	31	75	6
4.4	0.1732	31	75	6
4.5	0.1772	31	75	6
4.6	0.1811	31	75	6
4.7	0.1850	31	75	6
4.8	0.1890	33	77	6
4.9	0.1929	33	77	6
5.0	0.1969	38	82	6
5.1	0.2008	38	82	6
5.2	0.2047	38	82	6
5.3	0.2087	38	82	6
5.4	0.2126	38	82	6

Size	Decimal Equivalent	Flute Length	Overall Length	Shank Dia.
5.5	0.2165	38	82	6
5.6	0.2205	41	85	6
5.7	0.2244	41	85	6
5.8	0.2283	41	85	6
5.9	0.2323	41	85	6
6.0	0.2362	41	85	6
6.1	0.2402	41	85	8
6.2	0.2441	41	85	8
6.3	0.2480	41	85	8
6.4	0.2520	41	85	8
6.5	0.2559	41	85	8
6.6	0.2598	43	87	8
6.7	0.2638	43	87	8
6.8	0.2677	43	87	8
6.9	0.2717	43	87	8
7.0	0.2756	43	87	8
7.1	0.2795	45	89	8
7.2	0.2835	45	89	8
7.3	0.2874	45	89	8
7.4	0.2913	45	89	8
7.5	0.2953	45	89	8
7.6	0.2992	48	92	8
7.7	0.3031	48	92	8
7.8	0.3071	48	92	8
7.9	0.3110	48	92	8
8.0	0.3150	48	92	8
8.1	0.3189	53	103	10
8.2	0.3228	53	103	10
8.3	0.3268	53	103	10
8.4	0.3307	53	103	10
8.5	0.3346	53	103	10
8.6	0.3386	55	105	10
8.7	0.3425	55	105	10
8.8	0.3465	55	105	10
8.9	0.3504	55	105	10
9.0	0.3543	55	105	10
9.1	0.3583	58	108	10
9.2	0.3622	58	108	10
9.3	0.3661	58	108	10
9.4	0.3701	58	108	10
9.5	0.3740	58	108	10
9.6	0.3780	60	110	10
9.7	0.3819	60	110	10
9.8	0.3858	60	110	10
9.9	0.3898	60	110	10

Size	Decimal Equivalent	Flute Length	Overall Length	Shank Dia.
10.0	0.3937	60	110	10
10.1	0.3976	66	123	12
10.2	0.4016	66	123	12
10.3	0.4055	66	123	12
10.4	0.4094	66	123	12
10.5	0.4134	66	123	12
10.6	0.4173	68	125	12
10.7	0.4213	68	125	12
10.8	0.4252	68	125	12
10.9	0.4291	68	125	12
11.0	0.4331	68	125	12
11.1	0.4370	71	128	12
11.2	0.4409	71	128	12
11.3	0.4449	71	128	12
11.4	0.4488	71	128	12
11.5	0.4528	71	128	12
11.6	0.4567	73	130	12
11.7	0.4606	73	130	12
11.8	0.4646	73	130	12
11.9	0.4685	73	130	12
12.0	0.4724	73	130	12
12.1	0.4764	76	135	14
12.2	0.4803	76	135	14
12.3	0.4843	76	135	14
12.4	0.4882	76	135	14
12.5	0.4921	76	135	14
12.6	0.4961	78	137	14
12.7	0.5000	78	137	14
12.8	0.5039	78	137	14
12.9	0.5079	78	137	14
13.0	0.5118	78	137	14
13.5	0.5315	84	144	14
14.0	0.5512	86	144	14
14.5	0.5709	89	149	16
15.0	0.5906	91	151	16
15.5	0.6102	94	158	16
16.0	0.6299	96	160	16
16.5	0.6496	102	168	18
17.0	0.6693	102	168	18
17.5	0.6890	102	168	18
18.0	0.7087	102	168	18
18.5	0.7283	114	184	20
19.0	0.7480	114	184	20
19.5	0.7677	114	184	20
20.0	0.7874	114	184	20

1 per tube

* JAPAN STOCK ITEM : Please allow 2-3 weeks delivery

Technical Data

DRILLS

DRILLS Cutting Condition

END MILLS

END MILLS Cutting Condition

TAPS

TAPS Cutting Condition

Others

List No.9558 Metric Sizes



Range 4.5 to 16.0

SOLID CARBIDE AQUA COATED



This mist-hole drill having 3 times flute of drill diameter is most suitable for "Semi-dry(MQL)" drilling, and applied in high-speed and long life drilling of most workpiece materials from raw materials to hardened materials.

(Unit) : mm

Size	Decimal Equivalent	Flute Length	Overall Length	Shank Dia.
4.5	0.1772	25	78	5
5.0	0.1969	28	78	5
5.1	0.2008	31	82	6
5.5	0.2165	31	82	6
5.6	0.2205	33	82	6
6.0	0.2362	33	82	6
6.1	0.2402	36	88	7
6.5	0.2559	36	88	7
6.7	0.2638	39	88	7
6.8	0.2677	39	88	7
6.9	0.2717	39	88	7
7.0	0.2756	39	88	7
7.1	0.2795	42	94	8
7.5	0.2953	42	94	8
7.9	0.3110	44	94	8
8.0	0.3150	44	94	8
8.5	0.3346	47	100	9
8.6	0.3386	50	100	9
8.8	0.3465	50	100	9
9.0	0.3543	50	100	9
9.1	0.3583	53	106	10
9.3	0.3661	53	106	10
9.5	0.3740	53	106	10
9.7	0.3819	55	106	10
9.8	0.3858	55	106	10
9.9	0.3898	55	106	10
10.0	0.3937	55	106	10
10.1	0.3976	58	116	11

Size	Decimal Equivalent	Flute Length	Overall Length	Shank Dia.
10.2	0.4016	58	116	11
10.3	0.4055	58	116	11
10.4	0.4094	58	116	11
10.5	0.4134	58	116	11
10.6	0.4173	61	116	11
10.7	0.4213	61	116	11
10.8	0.4252	61	116	11
10.9	0.4291	61	116	11
11.0	0.4331	61	116	11
11.1	0.4370	64	122	12
11.2	0.4409	64	122	12
11.3	0.4449	64	122	12
11.4	0.4488	64	122	12
11.5	0.4528	64	122	12
11.6	0.4567	66	122	12
11.7	0.4606	66	122	12
11.8	0.4646	66	122	12
11.9	0.4685	66	122	12
12.0	0.4724	66	122	12
12.1	0.4764	69	128	13
12.2	0.4803	69	128	13
12.3	0.4843	69	128	13
12.4	0.4882	69	128	13
12.5	0.4921	69	128	13
12.6	0.4961	72	128	13
12.8	0.5039	72	128	13
13.0	0.5118	72	128	13
13.3	0.5236	75	134	14

Size	Decimal Equivalent	Flute Length	Overall Length	Shank Dia.
13.4	0.5276	75	134	14
13.5	0.5315	75	134	14
13.6	0.5354	77	134	14
13.7	0.5394	77	134	14
13.8	0.5433	77	134	14
13.9	0.5472	77	134	14
14.0	0.5512	77	134	14
14.1	0.5551	80	140	15
14.3	0.5630	80	140	15
14.4	0.5669	80	140	15
14.5	0.5709	80	140	15
14.6	0.5748	83	140	15
14.7	0.5787	83	140	15
14.8	0.5827	83	140	15
14.9	0.5866	83	140	15
15.0	0.5906	83	140	15
15.1	0.5945	86	146	16
15.2	0.5984	86	146	16
15.3	0.6024	86	146	16
15.4	0.6063	86	146	16
15.5	0.6102	86	146	16
15.6	0.6142	88	146	16
15.7	0.6181	88	146	16
15.8	0.6220	88	146	16
15.9	0.6260	88	146	16
16.0	0.6299	88	146	16

1 per tube

* JAPAN STOCK ITEM : Please allow 2-3 weeks delivery

Technical Data

DRILLS

DRILLS Cutting Condition

END MILLS

END MILLS Cutting Condition

TAPS

TAPS Cutting Condition

Others

List No.9554 Metric Sizes



Range 4.2 to 16.0

SOLID CARBIDE AQUA COATED



This mist-hole drill having 5 times flute of drill diameter is most suitable for "Semi-dry(MQL)" drilling, and applied in high-speed and long life drilling of most workpiece materials from raw materials to hardened materials.

(Unit) : mm

Size	Decimal Equivalent	Flute Length	Overall Length	Shank Dia.
4.2	0.1654	34	88	5
4.3	0.1693	34	88	5
4.5	0.1772	34	88	5
4.6	0.1811	38	88	5
4.8	0.1890	38	88	5
4.9	0.1929	38	88	5
5.0	0.1969	38	88	5
5.1	0.2008	42	95	6
5.2	0.2047	42	95	6
5.4	0.2126	42	95	6
5.5	0.2165	42	95	6
5.6	0.2205	45	95	6
5.7	0.2244	45	95	6
5.8	0.2283	45	95	6
6.0	0.2362	45	95	6
6.1	0.2402	49	103	7
6.2	0.2441	49	103	7
6.3	0.2480	49	103	7
6.4	0.2520	49	103	7
6.5	0.2559	49	103	7
6.6	0.2598	53	103	7
6.7	0.2638	53	103	7
6.8	0.2677	53	103	7
6.9	0.2717	53	103	7
7.0	0.2756	53	103	7
7.2	0.2835	57	111	8
7.3	0.2874	57	111	8
7.4	0.2913	57	111	8
7.5	0.2953	57	111	8
7.6	0.2992	60	111	8
7.7	0.3031	60	111	8
7.8	0.3071	60	111	8
8.0	0.3150	60	111	8
8.2	0.3228	64	119	9
8.4	0.3307	64	119	9

Size	Decimal Equivalent	Flute Length	Overall Length	Shank Dia.
8.5	0.3346	64	119	9
8.6	0.3386	68	119	9
8.7	0.3425	68	119	9
8.8	0.3465	68	119	9
8.9	0.3504	68	119	9
9.0	0.3543	68	119	9
9.2	0.3622	72	127	10
9.4	0.3701	72	127	10
9.5	0.3740	72	127	10
9.6	0.3780	75	127	10
9.7	0.3819	75	127	10
9.8	0.3858	75	127	10
9.9	0.3898	75	127	10
10.0	0.3937	75	127	10
10.1	0.3976	79	140	11
10.3	0.4055	79	140	11
10.4	0.4094	79	140	11
10.5	0.4134	79	140	11
10.6	0.4173	83	140	11
10.8	0.4252	83	140	11
11.0	0.4331	83	140	11
11.1	0.4370	87	148	12
11.2	0.4409	87	148	12
11.3	0.4449	87	148	12
11.4	0.4488	87	148	12
11.5	0.4528	87	148	12
11.6	0.4567	90	148	12
11.8	0.4646	90	148	12
11.9	0.4685	90	148	12
12.0	0.4724	90	148	12
12.1	0.4764	94	156	13
12.2	0.4803	94	156	13
12.3	0.4843	94	156	13
12.4	0.4882	94	156	13

Size	Decimal Equivalent	Flute Length	Overall Length	Shank Dia.
12.5	0.4921	94	156	13
12.6	0.4961	98	156	13
12.7	0.5000	98	156	13
12.8	0.5039	98	156	13
12.9	0.5079	98	156	13
13.0	0.5118	98	156	13
13.1	0.5157	102	164	14
13.2	0.5197	102	164	14
13.4	0.5276	102	164	14
13.5	0.5315	102	164	14
13.6	0.5354	105	164	14
13.7	0.5394	105	164	14
13.8	0.5433	105	164	14
13.9	0.5472	105	164	14
14.0	0.5512	105	164	14
14.2	0.5591	109	172	15
14.3	0.5630	109	172	15
14.4	0.5669	109	172	15
14.5	0.5709	109	172	15
14.6	0.5748	113	172	15
14.7	0.5787	113	172	15
14.8	0.5827	113	172	15
14.9	0.5866	113	172	15
15.0	0.5906	113	172	15
15.1	0.5945	117	180	16
15.2	0.5984	117	180	16
15.3	0.6024	117	180	16
15.4	0.6063	117	180	16
15.5	0.6102	117	180	16
15.6	0.6142	120	180	16
15.7	0.6181	120	180	16
15.8	0.6220	120	180	16
15.9	0.6260	120	180	16
16.0	0.6299	120	180	16

1 per tube

* JAPAN STOCK ITEM : Please allow 2-3 weeks delivery

Technical Data

DRILLS

DRILLS Cutting Condition

END MILLS

END MILLS Cutting Condition

TAPS

TAPS Cutting Condition

Others

AQUA DRILLS WITH MIST-HOLE 7D / METRIC SIZES / FRACTIONAL SIZES

USA & JAPAN
STOCK ITEM*

List No.9556 Metric Sizes

List No.9569 Fractional



Range L9556 5.0 to 16.0
Range L9569 3/16 to 5/8

SOLID CARBIDE AQUA COATED



This mist-hole drill having 7 times flute of drill diameter is most suitable for "Semi-dry(MQL)" drilling, and applied in high-speed and long life drilling of most workpiece materials from raw materials to hardened materials.

L9556 (JAPAN STOCK)

(Unit) : mm

L9569 (USA STOCK)

Size	Decimal Equivalent	Flute Length	Overall Length	Shank Dia.
5.0	0.1969	48	97	5
5.1	0.2008	53	110	6
5.5	0.2165	53	110	6
6.0	0.2362	57	110	6
6.1	0.2402	62	120	7
6.5	0.2559	62	120	7
6.8	0.2677	67	120	7
6.9	0.2717	67	120	7
7.0	0.2756	67	120	7
7.5	0.2953	72	130	8
8.0	0.3150	76	130	8
8.5	0.3346	81	140	9
8.6	0.3386	86	140	9
8.8	0.3465	86	140	9
9.0	0.3543	86	140	9
9.5	0.3740	91	150	10
9.8	0.3858	95	150	10
9.9	0.3898	95	150	10
10.0	0.3937	95	150	10
10.3	0.4055	100	170	11
10.5	0.4134	100	170	11
10.8	0.4252	105	170	11
11.0	0.4331	105	170	11
11.5	0.4528	110	180	12
12.0	0.4724	114	180	12
12.5	0.4921	119	190	13
13.0	0.5118	124	190	13
13.5	0.5315	129	200	14
14.0	0.5512	133	200	14
14.5	0.5709	138	210	15
15.0	0.5906	143	210	15
15.5	0.6102	148	220	16
16.0	0.6299	152	220	16

1 per tube

* JAPAN STOCK ITEM : Please allow 2-3 weeks delivery

Size	Decimal Equivalent	Flute Length	Overall Length	Shank Dia.
3/16	0.1875	1-7/8	3-13/16	3/16
13/64	0.2031	2-1/16	4-21/64	13/64
7/32	0.2188	2-15/64	4-21/64	7/32
15/64	0.2344	2-15/64	4-21/64	15/64
1/4	0.2500	2-7/16	4-23/32	1/4
17/64	0.2656	2-5/8	4-23/32	17/64
9/32	0.2813	2-53/64	5-7/64	9/32
19/64	0.2969	2-63/64	5-7/64	19/64
5/16	0.3125	2-63/64	5-7/64	5/16
21/64	0.3281	3-3/16	5-1/2	21/64
11/32	0.3438	3-3/8	5-1/2	11/32
23/64	0.3594	3-37/64	5-57/64	23/64
3/8	0.3750	3-37/64	5-57/64	3/8
25/64	0.3906	3-47/64	5-57/64	25/64
13/32	0.4063	3-59/64	6-11/16	13/32
27/64	0.4219	4-3/16	6-11/16	27/64
7/16	0.4375	4-21/64	7-5/64	7/16
29/64	0.4531	4-31/64	7-5/64	29/64
15/32	0.4688	4-31/64	7-5/64	15/32
31/64	0.4844	4-43/64	7-15/32	31/64
1/2	0.5000	4-7/8	7-15/32	1/2
17/32	0.5313	5-5/64	7-7/8	17/32
9/16	0.5625	5-27/64	8-17/64	9/16
19/32	0.5938	5-13/16	8-21/32	19/32
5/8	0.6250	5-63/64	8-21/32	5/8

1 per tube

Technical
Data

DRILLS

DRILLS
Cutting Condition

END MILLS

END MILLS
Cutting Condition

TAPS

TAPS
Cutting Condition

Others

List No.9546 High Performance



Range 3.0 to 12.0

SOLID CARBIDE AQUA COATED

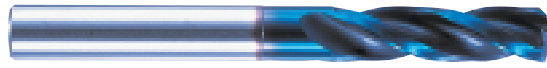

This drill having balanced 3 flutes is suitable for precision drilling without reaming.

(Unit) : mm

Size	Decimal Equivalent	Flute Length	Overall Length	Shank Dia.
3.0	0.1181	16	48	3
3.1	0.1220	18	50	4
3.2	0.1260	18	50	4
3.3	0.1299	18	50	4
3.4	0.1339	20	52	4
3.5	0.1378	20	52	4
3.6	0.1417	20	52	4
3.7	0.1457	20	52	4
3.8	0.1496	22	54	4
3.9	0.1535	22	54	4
4.0	0.1575	22	54	4
4.1	0.1614	22	66	6
4.2	0.1654	22	66	6
4.3	0.1693	24	68	6
4.4	0.1732	24	68	6
4.5	0.1772	24	68	6
4.6	0.1811	24	68	6
4.7	0.1850	24	68	6
4.8	0.1890	26	70	6
4.9	0.1929	26	70	6
5.0	0.1969	26	70	6
5.1	0.2008	26	70	6
5.2	0.2047	26	70	6
5.3	0.2087	26	70	6
5.4	0.2126	28	72	6
5.5	0.2165	28	72	6
5.6	0.2205	28	72	6
5.7	0.2244	28	72	6
5.8	0.2283	28	72	6
5.9	0.2323	28	72	6
6.0	0.2362	28	72	6
6.1	0.2402	31	75	8
6.2	0.2441	31	75	8
6.3	0.2480	31	75	8
6.4	0.2520	31	75	8
6.5	0.2559	31	75	8
6.6	0.2598	31	75	8
6.7	0.2638	31	75	8
6.8	0.2677	34	78	8
6.9	0.2717	34	78	8
7.0	0.2756	34	78	8
7.1	0.2795	34	78	8
7.2	0.2835	34	78	8
7.3	0.2874	34	78	8
7.4	0.2913	34	78	8
7.5	0.2953	34	78	8

Size	Decimal Equivalent	Flute Length	Overall Length	Shank Dia.
7.6	0.2992	37	81	8
7.7	0.3031	37	81	8
7.8	0.3071	37	81	8
7.9	0.3110	37	81	8
8.0	0.3150	37	81	8
8.1	0.3189	37	87	10
8.2	0.3228	37	87	10
8.3	0.3268	37	87	10
8.4	0.3307	37	87	10
8.5	0.3346	37	87	10
8.6	0.3386	40	90	10
8.7	0.3425	40	90	10
8.8	0.3465	40	90	10
8.9	0.3504	40	90	10
9.0	0.3543	40	90	10
9.1	0.3583	40	90	10
9.2	0.3622	40	90	10
9.3	0.3661	40	90	10
9.4	0.3701	40	90	10
9.5	0.3740	40	90	10
9.6	0.3780	43	93	10
9.7	0.3819	43	93	10
9.8	0.3858	43	93	10
9.9	0.3898	43	93	10
10.0	0.3937	43	93	10
10.1	0.3976	43	100	12
10.2	0.4016	43	100	12
10.3	0.4055	43	100	12
10.4	0.4094	43	100	12
10.5	0.4134	43	100	12
10.6	0.4173	43	100	12
10.7	0.4213	47	104	12
10.8	0.4252	47	104	12
10.9	0.4291	47	104	12
11.0	0.4331	47	104	12
11.1	0.4370	47	104	12
11.2	0.4409	47	104	12
11.3	0.4449	47	104	12
11.4	0.4488	47	104	12
11.5	0.4528	47	104	12
11.6	0.4567	47	104	12
11.7	0.4606	47	104	12
11.8	0.4646	47	104	12
11.9	0.4685	51	108	12
12.0	0.4724	51	108	12

Size		Tolerance (μm)
Above	Up to	
	3.0	±3
3.0	10.0	±4
10.0		±5

1 per tube
* JAPAN STOCK ITEM : Please allow 2-3 weeks delivery

Technical Data

DRILLS

DRILLS Cutting Condition

END MILLS

END MILLS Cutting Condition

TAPS

TAPS Cutting Condition

Others

List No.9548 High Performance

Range 2.0 to 12.0

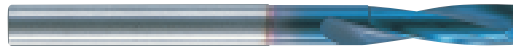
SOLID CARBIDE AQUA COATEDThis drill meets high efficiency drilling of hardened material.
(50~70HRC)

(Unit) : mm

Size	Decimal Equivalent	Flute Length	Overall Length	Shank Dia.
2.0	0.0787	12	44	3
2.1	0.0827	12	44	3
2.5	0.0984	14	46	3
2.6	0.1024	14	46	3
3.0	0.1181	16	48	3
3.4	0.1339	20	52	4
3.5	0.1378	20	52	4
4.0	0.1575	22	54	4
4.3	0.1693	24	68	6
4.5	0.1772	24	68	6
5.0	0.1969	26	70	6
5.1	0.2008	26	70	6
5.5	0.2165	28	72	6
6.0	0.2362	28	72	6
6.5	0.2559	31	75	8
6.9	0.2717	34	78	8
7.0	0.2756	34	78	8
7.5	0.2953	34	78	8
8.0	0.3150	37	81	8
8.5	0.3346	37	87	10
8.6	0.3386	40	90	10
9.0	0.3543	40	90	10
9.5	0.3740	40	90	10
10.0	0.3937	43	93	10
10.3	0.4055	43	100	12
10.5	0.4134	43	100	12
11.0	0.4331	47	104	12
11.5	0.4528	47	104	12
12.0	0.4724	51	108	12

1 per tube

* JAPAN STOCK ITEM : Please allow 2-3 weeks delivery

Technical
Data

DRILLS

DRILLS
Cutting Condition

END MILLS

END MILLS
Cutting Condition

TAPS

TAPS
Cutting Condition

Others

List No.9544 High Performance

SOLID CARBIDE AQUA COATED



Range 0.20 to 1.99



This drill is suitable for stable drilling in small diameter on many kind of materials from raw material to hardened material.

(Unit) : mm

Size	Decimal Equivalent	Flute Length	Overall Length	Shank Dia.
0.20	0.0079	2.5	38	3
0.21	0.0083	2.5	38	3
0.22	0.0087	2.5	38	3
0.23	0.0091	2.5	38	3
0.24	0.0094	2.5	38	3
0.25	0.0098	2.5	38	3
0.26	0.0102	2.5	38	3
0.27	0.0106	2.5	38	3
0.28	0.0110	2.5	38	3
0.29	0.0114	2.5	38	3
0.30	0.0118	3	38	3
0.31	0.0122	3	38	3
0.32	0.0126	3	38	3
0.33	0.0130	3	38	3
0.34	0.0134	3	38	3
0.35	0.0138	4	38	3
0.36	0.0142	4	38	3
0.37	0.0146	4	38	3
0.38	0.0150	4	38	3
0.39	0.0154	4	38	3
0.40	0.0157	5	38	3
0.41	0.0161	5	38	3
0.42	0.0165	5	38	3
0.43	0.0169	5	38	3
0.44	0.0173	5	38	3
0.45	0.0177	5	38	3
0.46	0.0181	5	38	3
0.47	0.0185	5	38	3
0.48	0.0189	5	38	3
0.49	0.0193	5	38	3
0.50	0.0197	6	38	3
0.51	0.0201	6	38	3
0.52	0.0205	6	38	3
0.53	0.0209	6	38	3
0.54	0.0213	6	38	3
0.55	0.0217	6	38	3
0.56	0.0220	6	38	3
0.57	0.0224	6	38	3
0.58	0.0228	6	38	3
0.59	0.0232	6	38	3
0.60	0.0236	7	38	3
0.61	0.0240	7	38	3
0.62	0.0244	7	38	3
0.63	0.0248	7	38	3
0.64	0.0252	7	38	3
0.65	0.0256	7	38	3
0.66	0.0260	7	38	3
0.67	0.0264	7	38	3
0.68	0.0268	7	38	3
0.69	0.0272	7	38	3
0.70	0.0276	9	38	3
0.71	0.0280	9	38	3
0.72	0.0283	9	38	3
0.73	0.0287	9	38	3
0.74	0.0291	9	38	3
0.75	0.0295	9	38	3
0.76	0.0299	9	38	3
0.77	0.0303	9	38	3
0.78	0.0307	9	38	3
0.79	0.0311	9	38	3

Size	Decimal Equivalent	Flute Length	Overall Length	Shank Dia.
0.80	0.0315	10	38	3
0.81	0.0319	10	38	3
0.82	0.0323	10	38	3
0.83	0.0327	10	38	3
0.84	0.0331	10	38	3
0.85	0.0335	10	38	3
0.86	0.0339	10	38	3
0.87	0.0343	10	38	3
0.88	0.0346	10	38	3
0.89	0.0350	10	38	3
0.90	0.0354	11	38	3
0.91	0.0358	11	38	3
0.92	0.0362	11	38	3
0.93	0.0366	11	38	3
0.94	0.0370	11	38	3
0.95	0.0374	11	38	3
0.96	0.0378	11	38	3
0.97	0.0382	11	38	3
0.98	0.0386	11	38	3
0.99	0.0390	11	38	3
1.00	0.0394	12	38	3
1.01	0.0398	12	38	3
1.02	0.0402	12	38	3
1.03	0.0406	12	38	3
1.04	0.0409	12	38	3
1.05	0.0413	12	38	3
1.06	0.0417	12	38	3
1.07	0.0421	12	38	3
1.08	0.0425	12	38	3
1.09	0.0429	12	38	3
1.10	0.0433	14	47	3
1.11	0.0437	14	47	3
1.12	0.0441	14	47	3
1.13	0.0445	14	47	3
1.14	0.0449	14	47	3
1.15	0.0453	14	47	3
1.16	0.0457	14	47	3
1.17	0.0461	14	47	3
1.18	0.0465	14	47	3
1.19	0.0469	14	47	3
1.20	0.0472	15	47	3
1.21	0.0476	15	47	3
1.22	0.0480	15	47	3
1.23	0.0484	15	47	3
1.24	0.0488	15	47	3
1.25	0.0492	15	47	3
1.26	0.0496	15	47	3
1.27	0.0500	15	47	3
1.28	0.0504	15	47	3
1.29	0.0508	15	47	3
1.30	0.0512	15	47	3
1.31	0.0516	15	47	3
1.32	0.0520	15	47	3
1.33	0.0524	15	47	3
1.34	0.0528	15	47	3
1.35	0.0531	15	47	3
1.36	0.0535	15	47	3
1.37	0.0539	15	47	3
1.38	0.0543	15	47	3
1.39	0.0547	15	47	3

Size	Decimal Equivalent	Flute Length	Overall Length	Shank Dia.
1.40	0.0551	15	47	3
1.41	0.0555	15	47	3
1.42	0.0559	15	47	3
1.43	0.0563	15	47	3
1.44	0.0567	15	47	3
1.45	0.0571	15	47	3
1.46	0.0575	15	47	3
1.47	0.0579	15	47	3
1.48	0.0583	15	47	3
1.49	0.0587	15	47	3
1.50	0.0591	15	47	3
1.51	0.0594	15	47	3
1.52	0.0598	15	47	3
1.53	0.0602	15	47	3
1.54	0.0606	15	47	3
1.55	0.0610	15	47	3
1.56	0.0614	15	47	3
1.57	0.0618	15	47	3
1.58	0.0622	15	47	3
1.59	0.0626	15	47	3
1.60	0.0630	15	47	3
1.61	0.0634	15	47	3
1.62	0.0638	15	47	3
1.63	0.0642	15	47	3
1.64	0.0646	15	47	3
1.65	0.0650	15	47	3
1.66	0.0654	15	47	3
1.67	0.0657	15	47	3
1.68	0.0661	15	47	3
1.69	0.0665	15	47	3
1.70	0.0669	15	47	3
1.71	0.0673	15	47	3
1.72	0.0677	15	47	3
1.73	0.0681	15	47	3
1.74	0.0685	15	47	3
1.75	0.0689	15	47	3
1.76	0.0693	15	47	3
1.77	0.0697	15	47	3
1.78	0.0701	15	47	3
1.79	0.0705	15	47	3
1.80	0.0709	15	47	3
1.81	0.0713	15	47	3
1.82	0.0717	15	47	3
1.83	0.0720	15	47	3
1.84	0.0724	15	47	3
1.85	0.0728	15	47	3
1.86	0.0732	15	47	3
1.87	0.0736	15	47	3
1.88	0.0740	15	47	3
1.89	0.0744	15	47	3
1.90	0.0748	15	47	3
1.91	0.0752	15	47	3
1.92	0.0756	15	47	3
1.93	0.0760	15	47	3
1.94	0.0764	15	47	3
1.95	0.0768	15	47	3
1.96	0.0772	15	47	3
1.97	0.0776	15	47	3
1.98	0.0780	15	47	3
1.99	0.0783	15	47	3

Tolerance of Drill Dia : +0.000
-0.009

1 per tube

Technical Data

DRILLS

DRILLS
Cutting Condition

END MILLS

END MILLS
Cutting Condition

TAPS

TAPS
Cutting Condition

Others

List No.9588 High Performance

Range 3.0 to 12.7

SOLID CARBIDE GS COATED

Utilize high accuracy shape of relief (2rake +XWthinning)

Coolant Through Solid Carbide Drill

"S" shaped cutting edge for superior chip removal

Made from High grade carbide with Composite Multi-layer GS Coating (Al-Ti-Cr based coating)

EDP NO	Size	Decimal Equivalent	Flute Length	Overall Length	Shank Dia
1405476	3.0	0.1181	17.5	68	3
1405482	3.1	0.1220	20	72	4
1405499	3.2	0.1260	20	72	4
1405504	3.3	0.1299	20	72	4
1405510	3.4	0.1339	20	72	4
1405527	3.5	0.1378	20	72	4
1405533	3.6	0.1417	22.5	72	4
1405540	3.7	0.1457	22.5	72	4
1405556	3.8	0.1496	22.5	72	4
1405562	3.9	0.1535	22.5	72	4
1405579	4.0	0.1575	22.5	72	4
1405585	4.1	0.1614	25	80	5
1405591	4.2	0.1654	25	80	5
1405607	4.3	0.1693	25	80	5
1405613	4.4	0.1732	25	80	5
1405620	4.5	0.1772	25	80	5
1405636	4.6	0.1811	27.5	80	5
1405642	4.7	0.1850	27.5	80	5
1405659	4.8	0.1890	27.5	80	5
1405665	4.9	0.1929	27.5	80	5
1405671	5.0	0.1969	27.5	80	5
1405688	5.1	0.2008	27.5	82	6
1405694	5.2	0.2047	27.5	82	6
1405700	5.3	0.2087	27.5	82	6
1405716	5.4	0.2126	27.5	82	6
1405722	5.5	0.2165	27.5	82	6
1405739	5.6	0.2205	30	82	6
1405745	5.7	0.2244	30	82	6
1405751	5.8	0.2283	30	82	6
1405768	5.9	0.2323	30	82	6
1405774	6.0	0.2362	30	82	6
1405780	6.1	0.2402	32.5	88	7
1405797	6.2	0.2441	32.5	88	7
1405802	6.3	0.2480	32.5	88	7
1406626	6.35	0.2500	32.5	88	1/4
1405819	6.4	0.2520	32.5	88	7
1405825	6.5	0.2559	32.5	88	7
1405831	6.6	0.2598	35	88	7
1405848	6.7	0.2638	35	88	7
1405854	6.8	0.2677	35	88	7
1405860	6.9	0.2717	35	88	7
1405877	7.0	0.2756	35	88	7
1405883	7.1	0.2795	37.5	94	8

EDP NO	Size	Decimal Equivalent	Flute Length	Overall Length	Shank Dia
1405890	7.2	0.2835	37.5	94	8
1405905	7.3	0.2874	37.5	94	8
1405911	7.4	0.2913	37.5	94	8
1405928	7.5	0.2953	37.5	94	8
1405934	7.6	0.2992	40	94	8
1405940	7.7	0.3031	40	94	8
1405957	7.8	0.3071	40	94	8
1405963	7.9	0.3110	40	94	8
1405970	8.0	0.3150	40	94	8
1405986	8.1	0.3189	42.5	100	9
1405992	8.2	0.3228	42.5	100	9
1406007	8.3	0.3268	42.5	100	9
1406013	8.4	0.3307	42.5	100	9
1406020	8.5	0.3346	42.5	100	9
1406036	8.6	0.3386	45	100	9
1406042	8.7	0.3425	45	100	9
1406059	8.8	0.3465	45	100	9
1406065	8.9	0.3504	45	100	9
1406071	9.0	0.3543	45	100	9
1406088	9.1	0.3583	47.5	106	10
1406094	9.2	0.3622	47.5	106	10
1406100	9.3	0.3661	47.5	106	10
1406116	9.4	0.3701	47.5	106	10
1406122	9.5	0.3740	47.5	106	10
1406735	9.525	0.3750	50	106	3/8
1406139	9.6	0.3780	50	106	10
1406145	9.7	0.3819	50	106	10
1406151	9.8	0.3858	50	106	10
1406168	9.9	0.3898	50	106	10
1406174	10.0	0.3937	50	106	10
1406180	10.1	0.3976	52.5	116	11
1406197	10.2	0.4016	52.5	116	11
1406202	10.3	0.4055	52.5	116	11
1406225	10.5	0.4134	52.5	116	11
1406248	10.7	0.4213	55	116	11
1406277	11.0	0.4331	55	116	11
1406328	11.5	0.4528	57.5	122	12
1406363	11.9	0.4685	60	122	12
1406370	12.0	0.4724	60	122	12
1406408	12.3	0.4843	62.5	128	13
1406420	12.5	0.4921	62.5	128	13
1406443	12.7	0.5000	65.0	128	13

Technical
Data

DRILLS

DRILLS
Cutting Condition

END MILLS

END MILLS
Cutting Condition

TAPS

TAPS
Cutting Condition

Others

List No.9589 High Performance



Range 1/8 to 1/2

SOLID CARBIDE GS COATED



Utilize high accuracy shape of relief (2rake +XWthinning)
Coolant Through Solid Carbide Drill
"S" shaped cutting edge for superior chip removal
Made from High grade carbide with Composite Multi-layer GS Coating (Al-Ti-Cr based coating)

() closest Fractional size

EDP NO	Size	Decimal Equivalent	Flute Length	Overall Length	Shank Dia
1406450	1/8	0.1250	20	72	1/8
1406466	#30	0.1285	20	72	5/32
1406472	#29	0.1360	20	72	5/32
1406489	9/64	0.1406	22.5	72	5/32
1405556	#25	0.1496	22.5	72	4
1406500	5/32	0.1562	22.5	72	5/32
1406517	#21	0.1590	25	80	3/16
1405585	(#20)	0.1614	25	80	5
1405591	(#19)	0.1654	25	80	5
1405607	(#18)	0.1693	25	80	5
1406530	11/64	0.1719	25	80	3/16
1405613	(#17)	0.1732	25	80	5
1405620	(#16)	0.1772	25	80	5
1406546	#15	0.1800	27.5	80	3/16
1405642	#13	0.1850	27.5	80	5
1406552	3/16	0.1875	27.5	80	3/16
1406569	#12	0.1890	27.5	80	5
1405671	(#9)	0.1969	27.5	80	5
1405688	#7	0.2008	27.5	82	6
1406581	13/64	0.2031	27.5	82	7/32
1405700	(#4)	0.2087	27.5	82	6
1405716	(#3)	0.2126	27.5	82	6
1406603	7/32	0.2188	30	82	7/32
1405739	(#2)	0.2205	30	82	6
1405751	(#1)	0.2283	30	82	6

EDP NO	Size	Decimal Equivalent	Flute Length	Overall Length	Shank Dia
1406610	15/64	0.2344	30	82	1/4
1406626	1/4	0.2500	32.5	88	1/4
1406632	F	0.2570	35	88	9/32
1406649	17/64	0.2656	35	88	9/32
1405860	I	0.2717	35	88	7
1406661	9/32	0.2812	37.5	94	9/32
1405928	(M)	0.2953	37.5	94	8
1406678	19/64	0.2969	40	94	5/16
1406684	5/16	0.3125	40	94	5/16
1405992	P	0.3228	42.5	100	9
1406690	Q	0.3320	42.5	100	11/32
1406036	(R)	0.3386	45	100	9
1406706	11/32	0.3438	45	100	11/32
1406088	(T)	0.3583	47.5	106	10
1406729	U	0.3680	47.5	106	3/8
1406735	3/8	0.3750	50	106	3/8
1406151	W	0.3858	50	106	10
1406168	(25/64)	0.3898	50	106	10
1406758	Y	0.4040	52.5	116	7/16
1406248	(27/64)	0.4213	55	116	11
1406787	7/16	0.4375	57.5	122	7/16
1406328	(29/64)	0.4528	57.5	122	12
1406363	(15/32)	0.4685	60	122	12
1406408	(31/64)	0.4843	62.5	128	13
1406443	1/2	0.5000	65.0	128	13

Technical Data

DRILLS

DRILLS Cutting Condition

END MILLS

END MILLS Cutting Condition

TAPS

TAPS Cutting Condition

Others

Technical Data

List No.9586 High Performance

SOLID CARBIDE GS COATED



Range 3.0 to 12.7



Utilize high accuracy shape of relief (2rake +XWthinning)
 Coolant Through Solid Carbide Drill
 "S" shaped cutting edge for superior chip removal
 Made from High grade carbide with Composite Multi-layer GS Coating (Al-Ti-Cr based coating)

DRILLS

DRILLS Cutting Condition

END MILLS

END MILLS Cutting Condition

TAPS

TAPS Cutting Condition

Others

EDP NO	Size	Decimal Equivalent	Flute Length	Overall Length	Shank Dia
1387628	3.0	0.1181	28	78	3
1387634	3.1	0.1220	32	86	4
1388573	3.175	0.1250	32	86	1/8
1387640	3.2	0.1260	32	86	4
1387657	3.3	0.1299	32	86	4
1387663	3.4	0.1339	32	86	4
1387670	3.5	0.1378	32	86	4
1387686	3.6	0.1417	36	86	4
1387692	3.7	0.1457	36	86	4
1387708	3.9	0.1535	36	86	4
1387714	4.0	0.1575	36	86	4
1387720	4.1	0.1614	40	98	5
1387737	4.2	0.1654	40	98	5
1387743	4.3	0.1693	40	98	5
1387750	4.4	0.1732	40	98	5
1387766	4.5	0.1772	40	98	5
1387772	4.6	0.1811	44	98	5
1387789	4.7	0.1850	44	98	5
1387795	4.8	0.1890	44	98	5
1387800	4.9	0.1929	44	98	5
1387817	5.0	0.1969	44	98	5
1387823	5.1	0.2008	44	100	6
1387846	5.3	0.2087	44	100	6
1387852	5.4	0.2126	44	100	6
1387869	5.5	0.2165	44	100	6
1387875	5.6	0.2205	48	100	6
1387881	5.7	0.2244	48	100	6
1387898	5.8	0.2283	48	100	6
1387910	6.0	0.2362	48	100	6
1387932	6.2	0.2441	52	109	7
1387949	6.3	0.2480	52	109	7
1388740	6.35	0.2500	52	109	1/4
1387955	6.4	0.2520	52	109	7
1387961	6.5	0.2559	52	109	7
1387978	6.6	0.2598	56	109	7
1387984	6.7	0.2638	56	109	7
1387990	6.8	0.2677	56	109	7
1388005	6.9	0.2717	56	109	7

EDP NO	Size	Decimal Equivalent	Flute Length	Overall Length	Shank Dia
1388011	7.0	0.2756	56	109	7
1388028	7.1	0.2795	60	118	8
1388057	7.4	0.2913	60	118	8
1388063	7.5	0.2953	60	118	8
1388086	7.7	0.3031	64	118	8
1388092	7.8	0.3071	64	118	8
1388108	7.9	0.3110	64	118	8
1388114	8.0	0.3150	64	118	8
1388120	8.1	0.3189	68	127	9
1388137	8.2	0.3228	68	127	9
1388166	8.5	0.3346	68	127	9
1388172	8.6	0.3386	72	127	9
1388189	8.7	0.3425	72	127	9
1388195	8.8	0.3465	72	127	9
1388200	8.9	0.3504	72	127	9
1388217	9.0	0.3543	72	127	9
1388252	9.4	0.3701	76	136	10
1388269	9.5	0.3740	76	136	10
1388859	9.525	0.3750	80	136	3/8
1388303	9.9	0.3898	80	136	10
1388310	10.0	0.3937	80	136	10
1388326	10.1	0.3976	84	149	11
1388332	10.2	0.4016	84	149	11
1388349	10.3	0.4055	84	149	11
1388361	10.5	0.4134	84	149	11
1388384	10.7	0.4213	88	149	11
1388390	10.8	0.4252	88	149	11
1388412	11.0	0.4331	88	149	11
1388435	11.2	0.4409	92	158	12
1388441	11.3	0.4449	92	158	12
1388464	11.5	0.4528	92	158	12
1388487	11.7	0.4606	96	158	12
1388493	11.8	0.4646	96	158	12
1388509	11.9	0.4685	96	158	12
1388515	12.0	0.4724	96	158	12
1388521	12.1	0.4764	100	167	13
1388550	12.5	0.4921	100	167	13
1388945	12.7	0.5000	104	167	1/2

List No.9587 High Performance



Range 1/8 to 1/2

SOLID CARBIDE GS COATED



Utilize high accuracy shape of relief (2rake +XWthinning)
Coolant Through Solid Carbide Drill
"S" shaped cutting edge for superior chip removal
Made from High grade carbide with Composite Multi-layer GS Coating (Al-Ti-Cr based coating)

() closest Fractional size

EDP NO	Size	Decimal Equivalent	Flute Length	Overall Length	Shank Dia
1388573	1/8	0.1250	32	86	1/8
1388580	#30	0.1285	32	86	5/32
1388596	#29	0.1360	32	86	5/32
1388601	9/64	0.1406	36	86	5/32
1388624	5/32	0.1562	36	86	5/32
1388630	#21	0.1590	40	98	3/16
1387720	(#20)	0.1614	40	98	5
1387737	(#19)	0.1654	40	98	5
1387743	(#18)	0.1693	40	98	5
1388653	11/64	0.1719	40	98	3/16
1387750	(#17)	0.1732	40	98	5
1387766	(#16)	0.1772	40	98	5
1388660	#15	0.1800	44	98	3/16
1387789	#13	0.1850	44	98	5
1388676	3/16	0.1875	44	98	3/16
1387795	#12	0.1890	44	98	5
1387817	(#9)	0.1969	44	98	5
1387823	#7	0.2008	44	100	6
1388704	13/64	0.2031	44	100	7/32
1387846	(#4)	0.2087	44	100	6
1387852	(#3)	0.2126	44	100	6
1388727	7/32	0.2188	48	100	7/32
1387875	(#2)	0.2205	48	100	6
1387898	(#1)	0.2283	48	100	6

EDP NO	Size	Decimal Equivalent	Flute Length	Overall Length	Shank Dia
1388733	15/64	0.2344	48	100	1/4
1388740	1/4	0.2500	52	109	1/4
1388756	F	0.2570	56	109	9/32
1388762	17/64	0.2656	56	109	9/32
1388005	I	0.2717	56	109	7
1388785	9/32	0.2812	60	118	9/32
1388063	(M)	0.2953	60	118	8
1388791	19/64	0.2969	64	118	5/16
1388807	5/16	0.3125	64	118	5/16
1388137	P	0.3228	68	127	9
1388813	Q	0.3320	68	127	11/32
1388172	(R)	0.3386	72	127	9
1388820	11/32	0.3438	72	127	11/32
1388836	23/64	0.3594	76	136	3/8
1388842	U	0.3680	76	136	3/8
1388859	3/8	0.3750	80	136	3/8
1388303	(25/64)	0.3898	80	136	10
1388871	Y	0.4040	84	149	7/16
1388384	(27/64)	0.4213	88	149	11
1388900	7/16	0.4375	92	158	7/16
1388464	(29/64)	0.4528	92	158	12
1388509	(15/32)	0.4685	96	158	12
1388945	1/2	0.5000	104	167	1/2

Technical Data

DRILLS

DRILLS Cutting Condition

END MILLS

END MILLS Cutting Condition

TAPS

TAPS Cutting Condition

Others

List No.9566



SOLID CARBIDE GS COATED



Precision guide hole drills for MQL Long Drills
Coolant Thru Solid Carbide drills
Double margin to provide accurate and straight guide hole for MQL Long Drills

Technical Data

DRILLS

DRILLS Cutting Condition

END MILLS

END MILLS Cutting Condition

TAPS

TAPS Cutting Condition

Others

EDP No	Size D Metric	Decimal Equivalent	Flute Length	Overall Length	Shank Dia	Recommend Long Drill Dia		
						Metric	Decimal	Fractional
1396086	3.05	0.1201	20	72	4	3.00	0.1181	
1401470	3.23	0.1272	20	72	4	3.18	0.1250	1/8
1396166	3.85	0.1516	23	72	4	3.80	0.1496	
1396172	3.95	0.1555	23	72	4	3.90	0.1535	
1396189	4.05	0.1594	25	80	5	4.00	0.1575	
1396200	4.25	0.1673	25	80	5	4.20	0.1654	
1396217	4.35	0.1713	25	80	5	4.30	0.1693	
1396230	4.55	0.1791	28	80	5	4.50	0.1772	
1396246	4.65	0.1831	28	80	5	4.60	0.1811	
1396252	4.75	0.1870	28	80	5	4.70	0.1850	
1396269	4.85	0.1909	28	80	5	4.80	0.1890	
1396275	4.95	0.1949	28	80	5	4.90	0.1929	
1396281	5.05	0.1988	28	82	6	5.00	0.1969	
1396298	5.15	0.2028	28	82	6	5.10	0.2008	
1396326	5.45	0.2146	28	82	6	5.40	0.2126	
1396332	5.55	0.2185	30	82	6	5.50	0.2165	
1396349	5.65	0.2224	30	82	6	5.60	0.2205	
1396355	5.75	0.2264	30	82	6	5.70	0.2244	
1396361	5.85	0.2303	30	82	6	5.80	0.2283	
1396384	6.05	0.2382	33	88	7	6.00	0.2362	

EDP No	Size D Metric	Decimal Equivalent	Flute Length	Overall Length	Shank Dia	Recommend Long Drill Dia		
						Metric	Decimal	Fractional
1396406	6.25	0.2461	33	88	7	6.20	0.2441	
1396429	6.40	0.2520	33	88	7	6.35	0.2500	1/4
1396435	6.45	0.2539	33	88	7	6.40	0.2520	
1396441	6.55	0.2579	35	88	7	6.50	0.2559	
1396470	6.80	0.2677	35	88	7	6.75	0.2657	17/64
1396509	7.05	0.2776	38	94	8	7.00	0.2756	
1396515	7.15	0.2815	38	94	8	7.10	0.2795	
1396544	7.45	0.2933	38	94	8	7.40	0.2913	
1396550	7.55	0.2972	40	94	8	7.50	0.2953	
1396573	7.75	0.3051	40	94	8	7.70	0.3031	
1396580	7.85	0.3091	40	94	8	7.80	0.3071	
1396596	7.95	0.3130	40	94	8	7.90	0.3110	
1396601	8.05	0.3169	43	100	9	8.00	0.3150	
1396618	8.15	0.3209	43	100	9	8.10	0.3189	
1396653	8.55	0.3366	45	100	9	8.50	0.3346	
1396660	8.65	0.3406	45	100	9	8.60	0.3386	
1396682	8.80	0.3465	45	100	9	8.75	0.3445	11/32
1396710	9.05	0.3563	48	108	10	9.00	0.3543	
1396779	9.60	0.3780	50	108	10	9.55	0.3760	3/8
1396820	10.05	0.3957	53	118	11	10.00	0.3937	



Range 1/8 to (11/16)
Range 3.0 to 17.5

SOLID CARBIDE GS COATED COOLANT THRU



List No.9564 10D

Unit : mm

EDP No	Size D		Decimal Equivalent	Flute Length	Overall Length	Shank Dia
	Fractional	Metric				
1386300		3.0	0.1181	41	91	3
1386323	1/8	3.175	0.1250	48	98	1/8
1386369		3.5	0.1378	48	98	4
1386398	#25	3.8	0.1496	54	104	4
1386403		3.9	0.1535	54	104	4
1386410		4.0	0.1575	54	104	4
1386432	(#19)	4.2	0.1654	61	111	5
1386449	(#18)	4.3	0.1693	61	111	5
1386461	(#16)	4.5	0.1772	61	111	5
1386478		4.6	0.1811	68	118	5
1386484	#13	4.7	0.1850	68	118	5
1386490	#12	4.8	0.1890	68	118	5
1386506		4.9	0.1929	68	118	5
1386512	(#9)	5.0	0.1969	68	118	5
1386529	#7	5.1	0.2008	75	125	6
1386558	(#3)	5.4	0.2126	75	125	6
1386564		5.5	0.2165	75	125	6
1386570	(#2)	5.6	0.2205	81	131	6
1386587		5.7	0.2244	81	131	6
1386593	(#1)	5.8	0.2283	81	131	6
1386615		6.0	0.2362	81	131	6
1386638		6.2	0.2441	88	138	7
1386650	1/4	6.35	0.2500	88	138	1/4
1386667		6.4	0.2520	88	138	7
1386673		6.5	0.2559	88	138	7
1386701	17/64	6.75	0.2656	95	145	17/64
1386730		7.0	0.2756	95	145	7
1386747		7.1	0.2795	102	152	8
1386776		7.4	0.2913	102	152	8
1386782	(M)	7.5	0.2953	102	152	8
1386804		7.7	0.3031	108	158	8
1386810		7.8	0.3071	108	158	8
1386827		7.9	0.3110	108	158	8
1386833		8.0	0.3150	108	158	8
1386840		8.1	0.3189	115	165	9
1386885		8.5	0.3346	115	165	9
1386913	11/32	8.73	0.3438	122	172	11/32
1386942		9.0	0.3543	122	172	9
1387009	3/8	9.525	0.3750	135	185	3/8
1387050		10.0	0.3937	135	185	10
1409814		10.3	0.4055	140	205	11
1409820	(7/16)	11.1	0.4370	155	215	12
1409837		11.2	0.4409	155	215	12
1409843	(17/32)	13.5	0.5315	165	215	14
1409850		14.0	0.5512	180	240	14
1409866	9/16	14.28	0.5622	170	220	15
1409872	(11/16)	17.5	0.6890	205	260	18

NOTE : Pilot Hole Drill (L9566) sizes for 10D,15D, 20D, 25D are available and in stock. Please inquire for available sizes.

List No.9536 15D

() closest Fractional size

Unit : mm

EDP No	Size D		Decimal Equivalent	Flute Length	Overall Length	Shank Dia
	Fractional	Metric				
1383892		4.0	0.1575	80	130	4
1383908	(#16)	4.5	0.1772	90	140	5
1383914	(#9)	5.0	0.1969	100	150	5
1383920		5.5	0.2165	110	160	6
1383937		6.0	0.2362	120	170	6
1384016	1/4	6.35	0.2500	130	180	1/4
1383943		6.5	0.2559	130	180	7
1383950		7.0	0.2756	140	190	7
1383966	(M)	7.5	0.2953	150	200	8
1383972		8.0	0.3150	160	210	8
1383989		8.5	0.3346	170	220	9
1383995		9.0	0.3543	180	230	9
1384022	3/8	9.525	0.3750	190	240	3/8
1384000		10.0	0.3937	200	250	10

List No.9536 20D

Unit : mm

EDP No	Size D		Decimal Equivalent	Flute Length	Overall Length	Shank Dia
	Fractional	Metric				
1384039		4.0	0.1575	100	150	4
1384045	(#16)	4.5	0.1772	115	165	5
1384051	(#9)	5.0	0.1969	125	175	5
1384068		5.5	0.2165	140	190	6
1384074		6.0	0.2362	150	200	6
1384154	1/4	6.35	0.2500	165	215	1/4
1384080		6.5	0.2559	165	215	7
1384097		7.0	0.2756	175	225	7
1384102	(M)	7.5	0.2953	190	240	8
1384119		8.0	0.3150	200	250	8
1384125		8.5	0.3346	215	265	9
1384131		9.0	0.3543	225	275	9
1409551		9.3	0.3661	225	275	10
1384160	3/8	9.525	0.3750	240	290	3/8
1384148		10.0	0.3937	250	300	10

List No.9536 25D

Unit : mm

EDP No	Size D		Decimal Equivalent	Flute Length	Overall Length	Shank Dia
	Fractional	Metric				
1384183		4.0	0.1575	120	170	4
1384190	(#16)	4.5	0.1772	135	185	5
1384205	(#9)	5.0	0.1969	150	200	5
1384211		5.5	0.2165	165	215	6
1384228		6.0	0.2362	180	230	6
1384177	1/4	6.35	0.2500	195	245	1/4
1384234		6.5	0.2559	195	245	7
1384240		7.0	0.2756	210	260	7
1384257	(M)	7.5	0.2953	225	275	8
1384263		8.0	0.3150	240	290	8

Drill Dia. D		Tolerance
Above	Up to	
	3	0~0.01
3	6	0~0.012
6		0~0.015

•Tolerance of Shank Dia. : h6 •Point angle : 140°

MQL Drills Recommended Cutting Conditions

1 Guide Hole Drilling

- We recommend pre-drilling of guide holes.
- It is recommended that the pilot hole size be .05mm to .1mm bigger than the MQLPLD.
- Drill depth : 2-3D or deeper.
- Ensure a high precision hole is drilled for the guide.
- We recommend the Aqua Drill 3 Flutes for precision guide hole drilling.
- If the part is slanted or at an angle, use an endmill to mill a flat surface for the guide hole & MQLPLD.

2 Initial cutting with MQL Drill

- Penetrate the pilot hole at reduced RPMs.
- Stay about 2 to 3mm (.07"-1") short of the bottom of the guide hole.

3 Deep Hole Drilling

- Start cutting at the recommended speeds and feeds with continuous feed cycle(no pecking required)

4 Retracting the Drill from the hole

- After the drilling has been completed and drill depth has been achieved, retract the drill at reduced RPM's when exiting the hole.

5 Breaking Through

- When breaking through, the cutting edge can be damaged. Reduce feed rate.
- A feed rate of .005mm-.1mm/rev (.001-.004 IPR) is recommended.

Technical Data

DRILLS

DRILLS Cutting Condition

END MILLS

END MILLS Cutting Condition

TAPS

TAPS Cutting Condition

Others

HIGH PERFORMANCE DRILLS

DIAMOND COATED CARBIDE DRILLS

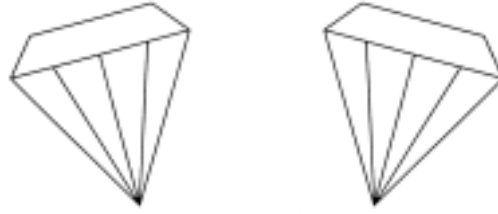
Technical
Data**List No.9501D** Diamond Coated**CARBIDE DIAMOND COATED**

DRILLS

DRILLS
Cutting Condition

Size	Decimal Equivalent	Flute Length	Overall Length
1/16	0.0625	7/8	1 7/8
1/8	0.1250	1 5/8	2 3/4
3/16	0.1875	2 5/16	3 1/2
1/4	0.2500	2 3/4	4
5/16	0.3125	3 1/16	4 1/2
3/8	0.3750	3 5/8	5
7/16	0.4375	4 1/16	5 1/2
1/2	0.5000	4 1/2	6

1 per tube

END MILLS

END MILLS
Cutting Condition

TAPS

TAPS
Cutting Condition

Others

List No.544 High Performance



HSS DLC COATED



Range 1.0 to 13.0

High efficiency drilling of Aluminum Alloy is available.

(Unit) : mm

Size	Decimal Equivalent	Flute Length	Overall Length	Shank Dia.
1.0	0.0394	12	50	3
1.1	0.0433	14	50	3
1.2	0.0472	16	50	3
1.3	0.0512	16	50	3
1.4	0.0551	18	50	3
1.5	0.0591	18	50	3
1.6	0.0630	20	56	3
1.7	0.0669	20	56	3
1.8	0.0709	22	56	3
1.9	0.0748	22	56	3
2.0	0.0787	24	56	3
2.1	0.0827	24	56	3
2.2	0.0866	25	56	3
2.3	0.0906	25	56	3
2.4	0.0945	30	64	3
2.5	0.0984	30	64	3
2.6	0.1024	30	64	3
2.7	0.1063	33	64	3
2.8	0.1102	33	64	3
2.9	0.1142	33	64	3
3.0	0.1181	33	64	3
3.1	0.1220	36	71	4
3.2	0.1260	36	71	4
3.3	0.1299	36	71	4
3.4	0.1339	39	71	4
3.5	0.1378	39	71	4
3.6	0.1417	39	71	4
3.7	0.1457	39	71	4
3.8	0.1496	43	75	4
3.9	0.1535	43	75	4
4.0	0.1575	43	75	4
4.1	0.1614	43	89	6
4.2	0.1654	43	89	6
4.3	0.1693	47	89	6
4.4	0.1732	47	89	6
4.5	0.1772	47	89	6
4.6	0.1811	47	89	6
4.7	0.1850	47	89	6
4.8	0.1890	52	94	6
4.9	0.1929	52	94	6
5.0	0.1969	52	94	6
5.1	0.2008	52	94	6
5.2	0.2047	52	94	6
5.3	0.2087	52	94	6
5.4	0.2126	57	99	6
5.5	0.2165	57	99	6
5.6	0.2205	57	99	6
5.7	0.2244	57	99	6
5.8	0.2283	57	99	6
5.9	0.2323	57	99	6
6.0	0.2362	57	99	6
6.1	0.2402	63	107	8
6.2	0.2441	63	107	8
6.3	0.2480	63	107	8
6.4	0.2520	63	107	8
6.5	0.2559	63	107	8
6.6	0.2598	63	107	8
6.7	0.2638	63	107	8
6.8	0.2677	69	113	8
6.9	0.2717	69	113	8
7.0	0.2756	69	113	8

Size	Decimal Equivalent	Flute Length	Overall Length	Shank Dia.
7.1	0.2795	69	113	8
7.2	0.2835	69	113	8
7.3	0.2874	69	113	8
7.4	0.2913	69	113	8
7.5	0.2953	69	113	8
7.6	0.2992	75	119	8
7.7	0.3031	75	119	8
7.8	0.3071	75	119	8
7.9	0.3110	75	119	8
8.0	0.3150	75	119	8
8.1	0.3189	75	125	10
8.2	0.3228	75	125	10
8.3	0.3268	75	125	10
8.4	0.3307	75	125	10
8.5	0.3346	75	125	10
8.6	0.3386	81	131	10
8.7	0.3425	81	131	10
8.8	0.3465	81	131	10
8.9	0.3504	81	131	10
9.0	0.3543	81	131	10
9.1	0.3583	81	131	10
9.2	0.3622	81	131	10
9.3	0.3661	81	131	10
9.4	0.3701	81	131	10
9.5	0.3740	81	131	10
9.6	0.3780	87	137	10
9.7	0.3819	87	137	10
9.8	0.3858	87	137	10
9.9	0.3898	87	137	10
10.0	0.3937	87	137	10
10.1	0.3976	87	144	12
10.2	0.4016	87	144	12
10.3	0.4055	87	144	12
10.4	0.4094	87	144	12
10.5	0.4134	87	144	12
10.6	0.4173	87	144	12
10.7	0.4213	94	151	12
10.8	0.4252	94	151	12
10.9	0.4291	94	151	12
11.0	0.4331	94	151	12
11.1	0.4370	94	151	12
11.2	0.4409	94	151	12
11.3	0.4449	94	151	12
11.4	0.4488	94	151	12
11.5	0.4528	94	151	12
11.6	0.4567	94	151	12
11.7	0.4606	94	151	12
11.8	0.4646	94	151	12
11.9	0.4685	101	158	12
12.0	0.4724	101	158	12
12.1	0.4764	101	158	12
12.2	0.4803	101	158	12
12.3	0.4843	101	158	12
12.4	0.4882	101	158	12
12.5	0.4921	101	158	12
12.6	0.4961	101	158	12
12.7	0.5000	101	158	12
12.8	0.5039	101	158	12
12.9	0.5079	101	158	12
13.0	0.5118	101	158	12

1 per tube

* JAPAN STOCK ITEM : Please allow 2-3 weeks delivery

Technical Data

DRILLS

DRILLS Cutting Condition

END MILLS

END MILLS Cutting Condition

TAPS

TAPS Cutting Condition

Others

List No.9524 High Performance

Range 0.5 to 1.9

SOLID CARBIDE DLC COATED

High-speed wet processing and dry processing of Aluminum
Alloy are available in small diameter.

(Unit) : mm

Size	Decimal Equivalent	Flute Length	Overall Length	Shank Diameter
0.5	0.0197	6	44	3
0.6	0.0236	7	44	3
0.7	0.0276	9	44	3
0.8	0.0315	10	44	3
0.9	0.0354	11	44	3
1.0	0.0394	12	47	3
1.1	0.0433	14	47	3
1.2	0.0472	15	47	3
1.3	0.0512	15	47	3
1.4	0.0551	15	47	3
1.5	0.0591	15	47	3
1.6	0.0630	15	47	3
1.7	0.0669	15	47	3
1.8	0.0709	15	47	3
1.9	0.0748	15	47	3

1 per tube

* JAPAN STOCK ITEM : Please allow 2-3 weeks delivery

Technical
Data

DRILLS

DRILLS
Cutting Condition

END MILLS

END MILLS
Cutting Condition

TAPS

TAPS
Cutting Condition

Others

List No.9520 High Performance



Range 2.0 to 12.0

SOLID CARBIDE DLC COATED



High-speed wet processing and dry processing of Aluminum Alloy are available.

(Unit) : mm

Size	Decimal Equivalent	Flute Length	Overall Length	Shank Dia.
2.0	0.0787	15	47	3
2.1	0.0827	15	47	3
2.2	0.0866	16	48	3
2.3	0.0906	16	48	3
2.4	0.0945	17	49	3
2.5	0.0984	17	49	3
2.6	0.1024	17	49	3
2.7	0.1063	19	51	3
2.8	0.1102	19	51	3
2.9	0.1142	19	51	3
3.0	0.1181	19	51	3
3.1	0.1220	21	53	4
3.2	0.1260	21	53	4
3.3	0.1299	21	53	4
3.4	0.1339	24	56	4
3.5	0.1378	24	56	4
3.6	0.1417	24	56	4
3.7	0.1457	24	56	4
3.8	0.1496	27	59	4
3.9	0.1535	27	59	4
4.0	0.1575	27	59	4
4.1	0.1614	27	71	6
4.2	0.1654	27	71	6
4.3	0.1693	31	75	6
4.4	0.1732	31	75	6
4.5	0.1772	31	75	6
4.6	0.1811	31	75	6
4.7	0.1850	31	75	6
4.8	0.1890	33	77	6
4.9	0.1929	33	77	6
5.0	0.1969	38	82	6
5.1	0.2008	38	82	6
5.2	0.2047	38	82	6
5.3	0.2087	38	82	6

Size	Decimal Equivalent	Flute Length	Overall Length	Shank Dia.
5.4	0.2126	38	82	6
5.5	0.2165	38	82	6
5.6	0.2205	41	85	6
5.7	0.2244	41	85	6
5.8	0.2283	41	85	6
5.9	0.2323	41	85	6
6.0	0.2362	41	85	6
6.1	0.2402	41	85	8
6.2	0.2441	41	85	8
6.3	0.2480	41	85	8
6.4	0.2520	41	85	8
6.5	0.2559	41	85	8
6.6	0.2598	43	87	8
6.7	0.2638	43	87	8
6.8	0.2677	43	87	8
6.9	0.2717	43	87	8
7.0	0.2756	43	87	8
7.1	0.2795	45	89	8
7.2	0.2835	45	89	8
7.3	0.2874	45	89	8
7.4	0.2913	45	89	8
7.5	0.2953	45	89	8
7.6	0.2992	48	92	8
7.7	0.3031	48	92	8
7.8	0.3071	48	92	8
7.9	0.3110	48	92	8
8.0	0.3150	48	92	8
8.1	0.3189	53	103	10
8.2	0.3228	53	103	10
8.3	0.3268	53	103	10
8.4	0.3307	53	103	10
8.5	0.3346	53	103	10
8.6	0.3386	55	105	10
8.7	0.3425	55	105	10

Size	Decimal Equivalent	Flute Length	Overall Length	Shank Dia.
8.8	0.3465	55	105	10
8.9	0.3504	55	105	10
9.0	0.3543	55	105	10
9.1	0.3583	58	108	10
9.2	0.3622	58	108	10
9.3	0.3661	58	108	10
9.4	0.3701	58	108	10
9.5	0.3740	58	108	10
9.6	0.3780	60	110	10
9.7	0.3819	60	110	10
9.8	0.3858	60	110	10
9.9	0.3898	60	110	10
10.0	0.3937	60	110	10
10.1	0.3976	66	123	12
10.2	0.4016	66	123	12
10.3	0.4055	66	123	12
10.4	0.4094	66	123	12
10.5	0.4134	66	123	12
10.6	0.4173	68	125	12
10.7	0.4213	68	125	12
10.8	0.4252	68	125	12
10.9	0.4291	68	125	12
11.0	0.4331	68	125	12
11.1	0.4370	71	128	12
11.2	0.4409	71	128	12
11.3	0.4449	71	128	12
11.4	0.4488	71	128	12
11.5	0.4528	71	128	12
11.6	0.4567	73	130	12
11.7	0.4606	73	130	12
11.8	0.4646	73	130	12
11.9	0.4685	73	130	12
12.0	0.4724	73	130	12

1 per tube

* JAPAN STOCK ITEM : Please allow 2-3 weeks delivery

Technical Data

DRILLS

DRILLS Cutting Condition

END MILLS

END MILLS Cutting Condition

TAPS

TAPS Cutting Condition

Others

STRAIGHT SHANK JOBBERS LENGTH DRILL / METRIC SIZES

List No.500 General Purpose



Bright Finish 0.2 to 1.95 mm

Black Oxide 2.0 to 17.5 mm

HIGH SPEED STEEL



Used in wide variety of normal conditions. Will work in a broad range of materials in both machine and portable drilling.

(Unit) : mm

Size	Decimal Equivalent	Flute Length	Overall Length
0.20	0.0079	3	19
0.22	0.0087	3.5	20
0.25	0.0098	3.5	20
0.28	0.0110	3.5	20
0.30	0.0118	3.5	20
0.32	0.0126	5.5	24
0.35	0.0138	5.5	24
0.38	0.0150	5.5	24
0.40	0.0157	5.5	24
0.42	0.0165	7.5	27
0.45	0.0177	7.5	27
0.48	0.0189	7.5	27
0.50	0.0197	7.5	30
0.55	0.0217	8.5	30
0.60	0.0236	8.5	30
0.65	0.0256	10	32
0.70	0.0276	10	32
0.75	0.0295	11	34
0.80	0.0315	11	34
0.85	0.0335	13	36
0.90	0.0354	13	36
0.95	0.0374	18	40
1.00	0.0394	18	40
1.05	0.0413	20	42
1.10	0.0433	20	42
1.15	0.0453	20	42
1.20	0.0472	20	42
1.25	0.0492	22	45
1.30	0.0512	22	45
1.35	0.0531	23	48
1.40	0.0551	23	48
1.45	0.0571	23	48
1.50	0.0591	23	48
1.55	0.0610	25	50
1.60	0.0630	25	50
1.65	0.0650	25	50
1.70	0.0669	25	50
1.75	0.0689	28	52
1.80	0.0709	28	52
1.85	0.0728	28	52
1.90	0.0748	28	52
1.95	0.0768	29	55
2.00	0.0787	29	55
2.05	0.0807	29	55
2.10	0.0827	29	55
2.15	0.0846	29	55
2.20	0.0866	33	58
2.25	0.0886	33	58
2.30	0.0906	33	58
2.35	0.0925	33	58
2.40	0.0945	35	61
2.45	0.0965	35	61
2.50	0.0984	35	61
2.55	0.1004	37	64
2.60	0.1024	37	64
2.65	0.1043	37	64
2.70	0.1063	37	64
2.75	0.1083	39	67

Size	Decimal Equivalent	Flute Length	Overall Length
2.80	0.1102	39	67
2.85	0.1122	39	67
2.90	0.1142	42	71
2.95	0.1161	42	71
3.00	0.1181	42	71
3.10	0.1220	42	71
3.20	0.1260	42	71
3.25	0.1280	42	71
3.30	0.1299	45	73
3.40	0.1339	45	73
3.50	0.1378	45	73
3.60	0.1417	48	76
3.70	0.1457	48	76
3.75	0.1476	48	76
3.80	0.1496	48	76
3.90	0.1535	51	79
4.00	0.1575	54	83
4.10	0.1614	54	83
4.20	0.1654	54	83
4.25	0.1673	54	83
4.30	0.1693	54	83
4.40	0.1732	56	86
4.50	0.1772	56	86
4.60	0.1811	56	86
4.70	0.1850	59	89
4.75	0.1870	59	89
4.80	0.1890	59	89
4.90	0.1929	62	92
5.00	0.1969	62	92
5.10	0.2008	62	92
5.20	0.2047	64	92
5.25	0.2067	64	95
5.30	0.2087	64	95
5.40	0.2126	64	95
5.50	0.2165	64	95
5.60	0.2205	67	98
5.70	0.2244	67	98
5.75	0.2264	67	98
5.80	0.2283	67	98
5.90	0.2323	67	98
6.00	0.2362	70	102
6.10	0.2402	70	102
6.20	0.2441	70	102
6.25	0.2461	70	102
6.30	0.2480	70	102
6.40	0.2520	73	105
6.50	0.2559	73	105
6.60	0.2598	73	105
6.70	0.2638	73	105
6.75	0.2657	73	105
6.80	0.2677	73	105
6.90	0.2717	73	105
7.00	0.2756	73	105
7.10	0.2795	75	108
7.20	0.2835	75	108
7.25	0.2854	75	108
7.30	0.2874	75	108
7.40	0.2913	78	111

Size	Decimal Equivalent	Flute Length	Overall Length
7.50	0.2953	78	111
7.60	0.2992	78	111
7.70	0.3031	81	114
7.75	0.3051	81	114
7.80	0.3071	81	114
7.90	0.3110	81	114
8.00	0.3150	81	114
8.10	0.3189	84	117
8.20	0.3228	84	117
8.25	0.3248	84	117
8.30	0.3268	84	117
8.40	0.3307	87	121
8.50	0.3346	87	121
8.60	0.3386	87	121
8.70	0.3425	87	121
8.75	0.3445	89	124
8.80	0.3465	89	124
8.90	0.3504	89	124
9.00	0.3543	89	124
9.10	0.3583	89	124
9.20	0.3622	92	127
9.25	0.3642	92	127
9.30	0.3661	92	127
9.40	0.3701	92	127
9.50	0.3740	92	127
9.60	0.3780	95	130
9.70	0.3819	95	130
9.75	0.3839	95	130
9.80	0.3858	95	130
9.90	0.3898	95	130
10.00	0.3937	95	130
10.20	0.4016	98	133
10.25	0.4035	98	133
10.50	0.4134	100	137
10.75	0.4232	103	140
10.80	0.4252	103	140
11.00	0.4331	103	140
11.20	0.4409	106	143
11.25	0.4429	106	143
11.50	0.4528	106	143
11.75	0.4626	109	146
11.80	0.4646	109	146
12.00	0.4724	111	149
12.20	0.4803	111	149
12.25	0.4823	111	149
12.50	0.4921	114	152
12.75	0.5020	114	152
12.80	0.5039	114	152
13.00	0.5118	114	152
13.50	0.5315	122	168
14.00	0.5512	122	168
14.50	0.5709	122	168
15.00	0.5906	132	181
15.50	0.6102	132	181
16.00	0.6299	132	181
16.50	0.6496	132	181
17.00	0.6693	143	194
17.50	0.6890	143	194

0.2 to 8.0 in package of 10, 8.1 to 13.0 in package of 5, 13.5 to 17.50 in package of 2

Technical Data

DRILLS

DRILLS Cutting Condition

END MILLS

END MILLS Cutting Condition

TAPS

TAPS Cutting Condition

Others

STRAIGHT SHANK COBALT DRILL / METRIC SIZES

JAPAN STOCK ITEM*

List No.6520 General Purpose



HIGH SPEED STEEL COBALT Black Oxide



Bright Finish 0.5 to 1.9 mm

This is general purpose cobalt HSS drills.

Black Oxide 2.0 to 13.0 mm

(Unit) : mm

Drill Dia.	Decimal Equivalent	Flute Length	Overall Length
0.5	0.0197	5	30
0.6	0.0236	5.5	30
0.7	0.0276	7.5	32
0.8	0.0315	8	34
0.9	0.0354	9	36
1.0	0.0394	10	40
1.1	0.0433	11	42
1.2	0.0472	13	42
1.3	0.0512	13	45
1.4	0.0551	14.5	48
1.5	0.0591	14.5	48
1.6	0.0630	16	50
1.7	0.0669	16	50
1.8	0.0709	17.5	52
1.9	0.0748	17.5	52
2.0	0.0787	20	55
2.1	0.0827	20	55
2.2	0.0866	23	58
2.3	0.0906	23	58
2.4	0.0945	24.5	61
2.5	0.0984	24.5	61
2.6	0.1024	26	64
2.7	0.1063	26	64
2.8	0.1102	27	67
2.9	0.1142	29.5	71
3.0	0.1181	29.5	71
3.1	0.1220	29.5	71
3.2	0.1260	29.5	71
3.3	0.1299	31.5	73
3.4	0.1339	31.5	73
3.5	0.1378	31.5	73
3.6	0.1417	33.5	76
3.7	0.1457	33.5	76
3.8	0.1496	33.5	76
3.9	0.1535	36	79
4.0	0.1575	38	83
4.1	0.1614	38	83
4.2	0.1654	38	83
4.3	0.1693	38	83
4.4	0.1732	39	86
4.5	0.1772	39	86
4.6	0.1811	39	86

Drill Dia.	Decimal Equivalent	Flute Length	Overall Length
4.7	0.1850	41	89
4.8	0.1890	41	89
4.9	0.1929	43	92
5.0	0.1969	43	92
5.1	0.2008	43	92
5.2	0.2047	45	95
5.3	0.2087	45	95
5.4	0.2126	45	95
5.5	0.2165	45	95
5.6	0.2205	47	98
5.7	0.2244	47	98
5.8	0.2283	47	98
5.9	0.2323	47	98
6.0	0.2362	49	102
6.1	0.2402	49	102
6.2	0.2441	49	102
6.3	0.2480	49	102
6.4	0.2520	51	105
6.5	0.2559	51	105
6.6	0.2598	51	105
6.7	0.2638	51	105
6.8	0.2677	51	105
6.9	0.2717	51	105
7.0	0.2756	51	105
7.1	0.2795	53	108
7.2	0.2835	53	108
7.3	0.2874	53	108
7.4	0.2913	55	111
7.5	0.2953	55	111
7.6	0.2992	55	111
7.7	0.3031	57	114
7.8	0.3071	57	114
7.9	0.3110	57	114
8.0	0.3150	57	114
8.1	0.3189	59	117
8.2	0.3228	59	117
8.3	0.3268	59	117
8.4	0.3307	61	121
8.5	0.3346	61	121
8.6	0.3386	61	121
8.7	0.3425	61	121
8.8	0.3465	63	124

Drill Dia.	Decimal Equivalent	Flute Length	Overall Length
8.9	0.3504	63	124
9.0	0.3543	63	124
9.1	0.3583	63	124
9.2	0.3622	65	127
9.3	0.3661	65	127
9.4	0.3701	65	127
9.5	0.3740	65	127
9.6	0.3780	67	130
9.7	0.3819	67	130
9.8	0.3858	67	130
9.9	0.3898	67	130
10.0	0.3937	67	130
10.1	0.3976	69	133
10.2	0.4016	69	133
10.3	0.4055	69	133
10.4	0.4094	69	133
10.5	0.4134	70	137
10.6	0.4173	70	137
10.7	0.4213	70	137
10.8	0.4252	72	140
10.9	0.4291	72	140
11.0	0.4331	72	140
11.1	0.4370	72	140
11.2	0.4409	75	143
11.3	0.4449	75	143
11.4	0.4488	75	143
11.5	0.4528	75	143
11.6	0.4567	77	146
11.7	0.4606	77	146
11.8	0.4646	77	146
11.9	0.4685	77	146
12.0	0.4724	78	149
12.1	0.4764	78	149
12.2	0.4803	78	149
12.3	0.4843	78	149
12.4	0.4882	80	152
12.5	0.4921	80	152
12.6	0.4961	80	152
12.7	0.5000	80	152
12.8	0.5039	80	152
12.9	0.5079	80	152
13.0	0.5118	80	152

0.5 to 8.0 in package 10, 8.1 to 13.0 in package 5

* JAPAN STOCK ITEM : Please allow 2-3 weeks delivery

Technical Data

DRILLS

DRILLS Cutting Condition

END MILLS

END MILLS Cutting Condition

TAPS

TAPS Cutting Condition

Others

Technical Data

List No.520P General Purpose



Range 0.5 to 13.0 mm

HIGH SPEED STEEL-TIN COATED



Used for high speed drilling. TiN coated.

(Unit) : mm

DRILLS

DRILLS Cutting Condition

END MILLS

END MILLS Cutting Condition

TAPS

TAPS Cutting Condition

Others

Drill Dia.	Decimal Equivalent	Flute Length	Overall Length
0.5	0.0197	6	22
0.6	0.0236	7	24
0.7	0.0276	9	28
0.8	0.0315	10	30
0.9	0.0354	11	32
1.0	0.0394	12	34
1.1	0.0433	14	36
1.2	0.0472	16	38
1.3	0.0512	16	38
1.4	0.0551	18	40
1.5	0.0591	18	40
1.6	0.0630	20	43
1.7	0.0669	20	43
1.8	0.0709	22	46
1.9	0.0748	22	46
2.0	0.0787	24	49
2.1	0.0827	24	49
2.2	0.0866	27	53
2.3	0.0906	27	53
2.4	0.0945	30	57
2.5	0.0984	30	57
2.6	0.1024	30	57
2.7	0.1063	33	61
2.8	0.1102	33	61
2.9	0.1142	33	61
3.0	0.1181	33	61
3.1	0.1220	36	65
3.2	0.1260	36	65
3.3	0.1299	36	65
3.4	0.1339	39	70
3.5	0.1378	39	70
3.6	0.1417	39	70
3.7	0.1457	39	70
3.8	0.1496	43	75
3.9	0.1535	43	75
4.0	0.1575	43	75
4.1	0.1614	43	75
4.2	0.1654	43	75
4.3	0.1693	47	80
4.4	0.1732	47	80
4.5	0.1772	47	80
4.6	0.1811	47	80

Drill Dia.	Decimal Equivalent	Flute Length	Overall Length
4.7	0.1850	47	80
4.8	0.1890	52	86
4.9	0.1929	52	86
5.0	0.1969	52	86
5.1	0.2008	52	86
5.2	0.2047	52	86
5.3	0.2087	52	86
5.4	0.2126	57	93
5.5	0.2165	57	93
5.6	0.2205	57	93
5.7	0.2244	57	93
5.8	0.2283	57	93
5.9	0.2323	57	93
6.0	0.2362	57	93
6.1	0.2402	63	101
6.2	0.2441	63	101
6.3	0.2480	63	101
6.4	0.2520	63	101
6.5	0.2559	63	101
6.6	0.2598	63	101
6.7	0.2638	63	101
6.8	0.2677	69	109
6.9	0.2717	69	109
7.0	0.2756	69	109
7.1	0.2795	69	109
7.2	0.2835	69	109
7.3	0.2874	69	109
7.4	0.2913	69	109
7.5	0.2953	69	109
7.6	0.2992	75	117
7.7	0.3031	75	117
7.8	0.3071	75	117
7.9	0.3110	75	117
8.0	0.3150	75	117
8.1	0.3189	75	117
8.2	0.3228	75	117
8.3	0.3268	75	117
8.4	0.3307	75	117
8.5	0.3346	75	117
8.6	0.3386	81	125
8.7	0.3425	81	125
8.8	0.3465	81	125

Drill Dia.	Decimal Equivalent	Flute Length	Overall Length
8.9	0.3504	81	125
9.0	0.3543	81	125
9.1	0.3583	81	125
9.2	0.3622	81	125
9.3	0.3661	81	125
9.4	0.3701	81	125
9.5	0.3740	81	125
9.6	0.3780	87	133
9.7	0.3819	87	133
9.8	0.3858	87	133
9.9	0.3898	87	133
10.0	0.3937	87	133
10.1	0.3976	87	133
10.2	0.4016	87	133
10.3	0.4055	87	133
10.4	0.4094	87	133
10.5	0.4134	87	133
10.6	0.4173	87	133
10.7	0.4213	94	142
10.8	0.4252	94	142
10.9	0.4291	94	142
11.0	0.4331	94	142
11.1	0.4370	94	142
11.2	0.4409	94	142
11.3	0.4449	94	142
11.4	0.4488	94	142
11.5	0.4528	94	142
11.6	0.4567	94	142
11.7	0.4606	94	142
11.8	0.4646	94	142
11.9	0.4685	101	151
12.0	0.4724	101	151
12.1	0.4764	101	151
12.2	0.4803	101	151
12.3	0.4843	101	151
12.4	0.4882	101	151
12.5	0.4921	101	151
12.6	0.4961	101	151
12.7	0.5000	101	151
12.8	0.5039	101	151
12.9	0.5079	101	151
13.0	0.5118	101	151

0.5 to 1.9 in package 10, 2.0 to 13.0 in package 1

* JAPAN STOCK ITEM : Please allow 2-3 weeks delivery

STRAIGHT SHANK JOBBERS LENGTH DRILLS / FRACTIONAL SIZES / WIRE GAUGE SIZES / LETTER SIZES

Technical Data

DRILLS

DRILLS Cutting Condition

END MILLS

END MILLS Cutting Condition

TAPS

TAPS Cutting Condition

Others

List No.501 General Purpose



Fractional : Range 3/64" to 11/16"
Wire : Range #1 to #60
Letter : Range A to Z

HIGH SPEED STEEL Black Oxide



Used in wide variety of normal conditions. Will work in a broad range of materials in both machine and portable drilling.

List No.501A General Purpose



Fractional : Range 1/64" to 11/16"
Wire : Range #1 to #80
Letter : Range A to Z

HIGH SPEED STEEL Bright Finish



Used in wide variety of normal conditions. Will work in a broad range of materials in both machine and portable drilling.

List No.6501 Aircraft NAS907-J



Fractional : Range 1/64" to 1/2"
Wire : Range #1 to #80
Letter : Range A to Z

HIGH SPEED STEEL COBALT Black Oxide



Manufactured with 135° Split Point.

List No.501P General Purpose



Fractional : Range 1/16" to 1/2"
Wire : Range #1 to #52

HIGH SPEED STEEL-TIN COATED



Used for high speed drilling. TIN coated.

List No.517P Parabolic



Fractional : Range 1/16" to 1/2"
Wire : Range #1 to #52

HIGH SPEED STEEL-TIN COATED



Used for drilling for 7D deep holes. Parabolic style gives maximum chip removal with no chip clogging. Suitable for hard material. TIN coated.

Fractional	Size		Decimal Equivalent	Flute Length	Overall Length
	Wire	Letter			
1/64	#80		0.0135	1/8	3/4
	#79		0.0145	1/8	3/4
			0.0156	3/16	3/4
	#78		0.0160	3/16	7/8
	#77		0.0180	3/16	7/8
	#76		0.0200	3/16	7/8
	#75		0.0210	1/4	1
	#74		0.0225	1/4	1
	#73		0.0240	5/16	1 1/8
	#72		0.0250	5/16	1 1/8
1/32	#71		0.0260	3/8	1 1/4
	#70		0.0280	3/8	1 1/4
	#69		0.0292	1/2	1 3/8
	#68		0.0310	1/2	1 3/8
			0.0313	1/2	1 3/8
	#67		0.0320	1/2	1 3/8
	#66		0.0330	1/2	1 3/8
	#65		0.0350	5/8	1 1/2
	#64		0.0360	5/8	1 1/2
	#63		0.0370	5/8	1 1/2
3/64	#62		0.0380	5/8	1 1/2
	#61		0.0390	11/16	1 5/8
	#60		0.0400	11/16	1 5/8
	#59		0.0410	11/16	1 5/8
	#58		0.0420	11/16	1 5/8
	#57		0.0430	3/4	1 3/4
	#56		0.0465	3/4	1 3/4
			0.0469	3/4	1 3/4
	#55		0.0520	7/8	1 7/8
	#54		0.0550	7/8	1 7/8
1/16	#53		0.0595	7/8	1 7/8
			0.0625	7/8	1 7/8
	#52		0.0635	7/8	1 7/8
	#51		0.0670	1	2
	#50		0.0700	1	2
	#49		0.0730	1	2
	#48		0.0760	1	2
			0.0781	1	2
	#47		0.0785	1	2
	#46		0.0810	1 1/8	2 1/8
5/64	#45		0.0820	1 1/8	2 1/8
	#44		0.0860	1 1/8	2 1/8
	#43		0.0890	1 1/4	2 1/4
	#42		0.0935	1 1/4	2 1/4
			0.0938	1 1/4	2 1/4
	#41		0.0960	1 3/8	2 3/8
	#40		0.0980	1 3/8	2 3/8
	#39		0.0995	1 3/8	2 3/8
	#38		0.1015	1 7/16	2 1/2
	#37		0.1040	1 7/16	2 1/2
7/64	#36		0.1065	1 7/16	2 1/2
			0.1094	1 1/2	2 5/8
	#35		0.1100	1 1/2	2 5/8
	#34		0.1110	1 1/2	2 5/8

**STRAIGHT SHANK JOBBERS LENGTH DRILLS /
List No.501, 501A, 6501, 501P, 517P**

Size			Decimal Equivalent	Flute Length	Overall Length
Fractional	Wire	Letter			
	#33		0.1130	1 1/2	2 5/8
	#32		0.1160	1 5/8	2 3/4
	#31		0.1200	1 5/8	2 3/4
1/8			0.1250	1 5/8	2 3/4
	#30		0.1285	1 5/8	2 3/4
	#29		0.1360	1 3/4	2 7/8
	#28		0.1405	1 3/4	2 7/8
9/64			0.1406	1 3/4	2 7/8
	#27		0.1440	1 7/8	3
	#26		0.1470	1 7/8	3
	#25		0.1495	1 7/8	3
	#24		0.1520	2	3 1/8
	#23		0.1540	2	3 1/8
5/32			0.1563	2	3 1/8
	#22		0.1570	2	3 1/8
	#21		0.1590	2 1/8	3 1/4
	#20		0.1610	2 1/8	3 1/4
	#19		0.1660	2 1/8	3 1/4
	#18		0.1695	2 1/8	3 1/4
	#16		0.1700	2 3/16	3 3/8
11/64			0.1719	2 1/8	3 1/4
	#17		0.1730	2 3/16	3 3/8
	#15		0.1800	2 3/16	3 3/8
	#14		0.1820	2 3/16	3 3/8
	#13		0.1850	2 5/16	3 1/2
3/16			0.1875	2 5/16	3 1/2
	#12		0.1890	2 5/16	3 1/2
	#11		0.1910	2 5/16	3 1/2
	#10		0.1935	2 7/16	3 5/8
	#9		0.1960	2 7/16	3 5/8
	#8		0.1990	2 7/16	3 5/8
	#7		0.2010	2 7/16	3 5/8
13/64			0.2031	2 7/16	3 5/8
	#6		0.2040	2 1/2	3 3/4
	#5		0.2055	2 1/2	3 3/4
	#4		0.2090	2 1/2	3 3/4
	#3		0.2130	2 1/2	3 3/4
7/32			0.2188	2 1/2	3 3/4
	#2		0.2210	2 5/8	3 7/8
	#1		0.2280	2 5/8	3 7/8
		A	0.2344	2 5/8	3 7/8
15/64			0.2344	2 5/8	3 7/8
		B	0.2380	2 3/4	4
		C	0.2420	2 3/4	4
		D	0.2460	2 3/4	4
		E	0.2500	2 3/4	4
1/4			0.2500	2 3/4	4
		F	0.2570	2 7/8	4 1/8

Size			Decimal Equivalent	Flute Length	Overall Length
Fractional	Wire	Letter			
		G	0.2610	2 7/8	4 1/8
17/64			0.2656	2 7/8	4 1/8
		H	0.2660	2 7/8	4 1/8
		I	0.2720	2 7/8	4 1/8
		J	0.2770	2 7/8	4 1/8
		K	0.2810	2 15/16	4 1/4
9/32			0.2813	2 15/16	4 1/4
		L	0.2900	2 15/16	4 1/4
		M	0.2950	3 1/16	4 3/8
19/64			0.2969	3 1/16	4 3/8
		N	0.3020	3 1/16	4 3/8
5/16			0.3125	3 3/16	4 1/2
		O	0.3160	3 3/16	4 1/2
		P	0.3230	3 5/16	4 5/8
21/64			0.3281	3 5/16	4 5/8
		Q	0.3320	3 7/16	4 3/4
		R	0.3390	3 7/16	4 3/4
11/32			0.3438	3 7/16	4 3/4
		S	0.3480	3 1/2	4 7/8
		T	0.3580	3 1/2	4 7/8
23/64			0.3594	3 1/2	4 7/8
		U	0.3680	3 5/8	5
3/8			0.3750	3 5/8	5
		V	0.3770	3 5/8	5
		W	0.3860	3 3/4	5 1/8
25/64			0.3906	3 3/4	5 1/8
		X	0.3970	3 3/4	5 1/8
		Y	0.4040	3 7/8	5 1/4
13/32			0.4063	3 7/8	5 1/4
		Z	0.4130	3 7/8	5 1/4
27/64			0.4219	3 15/16	5 3/8
7/16			0.4375	4 1/16	5 1/2
29/64			0.4531	4 3/16	5 5/8
15/32			0.4688	4 5/16	5 3/4
31/64			0.4844	4 3/8	5 7/8
1/2			0.5000	4 1/2	6
33/64			0.5156	4 13/16	6 5/8
17/32			0.5313	4 13/16	6 5/8
35/64			0.5469	4 13/16	6 5/8
9/16			0.5625	4 13/16	6 5/8
37/64			0.5781	4 13/16	6 5/8
19/32			0.5938	5 3/16	7 1/8
39/64			0.6094	5 3/16	7 1/8
5/8			0.6250	5 3/16	7 1/8
41/64			0.6406	5 3/16	7 1/8
21/32			0.6563	5 3/16	7 1/8
43/64			0.6719	5 5/8	7 5/8
11/16			0.6875	5 5/8	7 5/8

Fractional sizes : 1/64 to 5/16 in package of 10; 21/64 to 1/2 in packages of 5. 33/64 to 11/16 in package of 2.

Wire gauge sizes : All Sizes in Packages of 10

Letter sizes : A to N in package of 10, O to Z in package of 5

Technical Data

DRILLS

DRILLS
Cutting Condition

END MILLS

END MILLS
Cutting Condition

TAPS

TAPS
Cutting Condition

Others

SCREW MACHINE LENGTH / FRACTIONAL SIZES / WIRE GAUGE SIZES / LETTER SIZES

Technical Data

DRILLS

DRILLS Cutting Condition

END MILLS

END MILLS Cutting Condition

TAPS

TAPS Cutting Condition

Others

List No.561 General Purpose



Fractional : Range 3/64" to 2"
Wire : Range #1 to #60
Letter : Range A to Z

HIGH SPEED STEEL Bright Finish



Manufactured with short overall and flute length.

List No.561P General Purpose



Fractional : Range 1/16" to 1/2"
Wire : Range #1 to #52

HIGH SPEED STEEL-TIN COATED



Manufactured with short overall and flute length with TiN coated.

List No.563 Aircraft NAS907-C



Fractional : Range 3/64" to 1/2"
Wire : Range #1 to #52
Letter : Range A to Z

HIGH SPEED STEEL Black Oxide



Standard NAS907 Type C. Manufactured with short overall and flute length.

List No.6563 Aircraft NAS907-C



Fractional : **Bright Finish** 3/64 to 7/64
Black Oxide 1/8 to 1/2
Wire : **Bright Finish** #32 to #52
Black Oxide #1 to #31
Letter : Range A to Z

HIGH SPEED STEEL COBALT



Standard NAS907 Type C. Manufactured with short overall and flute length.

Fractional	Size		Decimal Equivalent	Flute Length	Overall Length	Shank Diameter
	Wire	Letter				
	#60		0.0400	1/2	1 3/8	#60
	#59		0.0410	1/2	1 3/8	#59
	#58		0.0420	1/2	1 3/8	#58
	#57		0.0430	1/2	1 3/8	#57
	#56		0.0465	1/2	1 3/8	#56
3/64			0.0469	1/2	1 3/8	3/64
	#55		0.0520	5/8	1 5/8	#55
	#54		0.0550	5/8	1 5/8	#54
	#53		0.0595	5/8	1 5/8	#53
1/16			0.0625	5/8	1 5/8	1/16
	#52		0.0635	11/16	1 11/16	#52
	#51		0.0670	11/16	1 11/16	#51
	#50		0.0700	11/16	1 11/16	#50
	#49		0.0730	11/16	1 11/16	#49
	#48		0.0760	11/16	1 11/16	#48
5/64			0.0781	11/16	1 11/16	5/64
	#47		0.0785	3/4	1 3/4	#47
	#46		0.0810	3/4	1 3/4	#46
	#45		0.0820	3/4	1 3/4	#45
	#44		0.0860	3/4	1 3/4	#44
	#43		0.0890	3/4	1 3/4	#43
	#42		0.0935	3/4	1 3/4	#42
3/32			0.0938	3/4	1 3/4	3/32
	#41		0.0960	13/16	1 13/16	#41
	#40		0.0980	13/16	1 13/16	#40
	#39		0.0995	13/16	1 13/16	#39
	#38		0.1015	13/16	1 13/16	#38
	#37		0.1040	13/16	1 13/16	#37
	#36		0.1065	13/16	1 13/16	#36
7/64			0.1094	13/16	1 13/16	7/64
	#35		0.1100	7/8	1 7/8	#35
	#34		0.1110	7/8	1 7/8	#34
	#33		0.1130	7/8	1 7/8	#33
	#32		0.1160	7/8	1 7/8	#32
	#31		0.1200	7/8	1 7/8	#31
1/8			0.1250	7/8	1 7/8	1/8
	#30		0.1285	15/16	1 15/16	#30
	#29		0.1360	15/16	1 15/16	#29
	#28		0.1405	15/16	1 15/16	#28
9/64			0.1406	15/16	1 15/16	9/64
	#27		0.1440	1	2 1/16	#27
	#26		0.1470	1	2 1/16	#26
	#25		0.1495	1	2 1/16	#25
	#24		0.1520	1	2 1/16	#24
	#23		0.1540	1	2 1/16	#23
5/32			0.1563	1	2 1/16	5/32
	#22		0.1570	1 1/16	2 1/8	#22
	#21		0.1590	1 1/16	2 1/8	#21
	#20		0.1610	1 1/16	2 1/8	#20
	#19		0.1660	1 1/16	2 1/8	#19
	#18		0.1695	1 1/16	2 1/8	#18
11/64			0.1719	1 1/16	2 1/8	11/64
	#17		0.1730	1 1/8	2 3/16	#17
	#16		0.1770	1 1/8	2 3/16	#16
	#15		0.1800	1 1/8	2 3/16	#15
	#14		0.1820	1 1/8	2 3/16	#14
	#13		0.1850	1 1/8	2 3/16	#13
3/16			0.1875	1 1/8	2 3/16	3/16
	#12		0.1890	1 3/16	2 1/4	#12

**SCREW MACHINE LENGTH /
List No.561, 561P, 563, 6563**

Size			Decimal Equivalent	Flute Length	Overall Length	Shank Diameter
Fractional	Wire	Letter				
	#11		0.1910	1 3/16	2 1/4	#11
	#10		0.1935	1 3/16	2 1/4	#10
	#9		0.1960	1 3/16	2 1/4	#9
	#8		0.1990	1 3/16	2 1/4	#8
	#7		0.2010	1 3/16	2 1/4	#7
13/64			0.2031	1 3/16	2 1/4	13/64
	#6		0.2040	1 1/4	2 3/8	#6
	#5		0.2055	1 1/4	2 3/8	#5
	#4		0.2090	1 1/4	2 3/8	#4
	#3		0.2130	1 1/4	2 3/8	#3
7/32			0.2188	1 1/4	2 3/8	7/32
	#2		0.2210	1 5/16	2 7/16	#2
	#1		0.2285	1 5/16	2 7/16	#1
		A	0.2340	1 5/16	2 7/16	A
15/64			0.2344	1 5/16	2 7/16	15/64
		B	0.2380	1 3/8	2 1/2	B
		C	0.2420	1 3/8	2 1/2	C
		D	0.2460	1 3/8	2 1/2	D
1/4			0.2500	1 3/8	2 1/2	1/4
		E	0.2500	1 3/8	2 1/2	E
		F	0.2570	1 7/16	2 5/8	F
		G	0.2610	1 7/16	2 5/8	G
17/64			0.2656	1 7/16	2 5/8	17/64
		H	0.2660	1 1/2	2 11/16	H
		I	0.2720	1 1/2	2 11/16	I
		J	0.2770	1 1/2	2 11/16	J
		K	0.2810	1 1/2	2 11/16	K
9/32			0.2813	1 1/2	2 11/16	9/32
		L	0.2900	1 9/16	2 3/4	L
		M	0.2950	1 9/16	2 3/4	M
19/64			0.2969	1 9/16	2 3/4	19/64
		N	0.3020	1 5/8	2 13/16	N
5/16			0.3125	1 5/8	2 13/16	5/16
		O	0.3160	1 11/16	2 15/16	O
		P	0.3230	1 11/16	2 15/16	P
21/64			0.3281	1 11/16	2 15/16	21/64
		Q	0.3320	1 11/16	3	Q
		R	0.3390	1 11/16	3	R
11/32			0.3438	1 11/16	3	11/32
		S	0.3480	1 3/4	3 1/16	S
		T	0.3580	1 3/4	3 1/16	T
23/64			0.3594	1 3/4	3 1/16	23/64
		U	0.3680	1 13/16	3 1/8	U
3/8			0.3750	1 13/16	3 1/8	3/8
		V	0.3770	1 7/8	3 1/4	V
		W	0.3860	1 7/8	3 1/4	W
25/64			0.3906	1 7/8	3 1/4	25/64
		X	0.3970	1 15/16	3 5/16	X
		Y	0.4040	1 15/16	3 5/16	Y
13/32			0.4063	1 5/16	3 5/16	13/32
		Z	0.4130	2	3 3/8	Z
27/64			0.4219	2	3 3/8	27/64
7/16			0.4375	2 1/16	3 7/16	7/16

Size			Decimal Equivalent	Flute Length	Overall Length	Shank Diameter
Fractional	Wire	Letter				
29/64			0.4531	2 1/8	3 9/16	29/64
15/32			0.4688	2 1/8	3 5/8	15/32
31/64			0.4844	2 3/16	3 11/16	31/64
1/2			0.5000	2 1/4	3 3/4	1/2
33/64			0.5156	2 3/8	3 7/8	33/64
17/32			0.5313	2 3/8	3 7/8	17/32
35/64			0.5469	2 1/2	4	35/64
9/16			0.5625	2 1/2	4	9/16
37/64			0.5781	2 5/8	4 1/8	37/64
19/32			0.5938	2 5/8	4 1/8	19/32
39/64			0.6094	2 3/4	4 1/4	39/64
5/8			0.6250	2 3/4	4 1/4	5/8
41/64			0.6406	2 7/8	4 1/2	41/64
21/32			0.6563	2 7/8	4 1/2	21/32
43/64			0.6719	2 7/8	4 5/8	43/64
11/16			0.6875	2 7/8	4 5/8	11/16
45/64			0.7031	3	4 3/4	45/64
23/32			0.7188	3	4 3/4	23/32
47/64			0.7344	3 1/8	5	47/64
3/4			0.7500	3 1/8	5	3/4
49/64			0.7656	3 1/4	5 1/8	49/64
25/32			0.7813	3 1/4	5 1/8	25/32
51/64			0.7969	3 3/8	5 1/4	51/64
13/16			0.8125	3 3/8	5 1/4	13/16
53/64			0.8281	3 1/2	5 3/8	53/64
27/32			0.8438	3 1/2	5 3/8	27/32
55/64			0.8594	3 1/2	5 1/2	55/64
7/8			0.8750	3 1/2	5 1/2	7/8
57/64			0.8906	3 5/8	5 5/8	57/64
29/32			0.9063	3 5/8	5 5/8	29/32
59/64			0.9219	3 3/4	5 3/4	59/64
15/16			0.9375	3 3/4	5 3/4	15/16
61/64			0.9531	3 7/8	5 7/8	61/64
31/32			0.9688	3 7/8	5 7/8	31/32
63/64			0.9844	4	6	63/64
1			1.0000	4	6	1
1 1/16			1.0625	4	6 1/4	1 1/16
1 1/8			1.1250	4	6 3/8	1 1/8
1 3/16			1.1875	4 1/4	6 5/8	1 3/16
1 1/4			1.2500	4 3/8	6 3/4	1 1/4
1 5/16			1.3125	4 3/8	7	1 5/16
1 3/8			1.3750	4 1/2	7 1/8	1 3/8
1 7/16			1.4375	4 3/4	7 3/8	1 7/16
1 1/2			1.5000	4 7/8	7 1/2	1 1/2
1 9/16			1.5625	4 7/8	7 3/4	1 9/16
1 5/8			1.6250	4 7/8	7 3/4	1 5/8
1 11/16			1.6875	5 1/8	8	1 11/16
1 3/4			1.7500	5 1/8	8	1 3/4
1 13/16			1.8125	5 3/8	8 1/4	1 13/16
1 7/8			1.8750	5 5/8	8 1/4	1 7/8
1 15/16			1.9375	5 5/8	8 1/2	1 15/16
2			2.0000	5 5/8	8 1/2	2

Fractional sizes : Sizes 3/64 to 5/16 in Package of 10; 21/64 to 1/2 in Package of 5
 Wire gauge sizes : All sizes in package of 10
 Letter sizes : A to N in package of 10; O to Z in package of 5

Technical Data

DRILLS

DRILLS Cutting Condition

END MILLS

END MILLS Cutting Condition

TAPS

TAPS Cutting Condition

Others

Technical Data

DRILLS

DRILLS Cutting Condition

END MILLS

END MILLS Cutting Condition

TAPS

TAPS Cutting Condition

Others

List No.531 General Purpose



Range 1/64" to 1/2"

HIGH SPEED STEEL Black Oxide



Used in wide range of materials under normal conditions. These drills are longer in length than jobbers drills.

List No.6531 General Purpose



Range 1/16" to 3/4"

HIGH SPEED STEEL COBALT Black Oxide



Used in Machining hard material, alloy steel, forgings and cast iron.

List No.545P Parabolic Style



Range 1/16" to 1/2"

HIGH SPEED STEEL-TIN COATED



Used for deep hole drilling. Parabolic design gives maximum chip removal with no chip clogging. TiN coated.

STRAIGHT SHANK TAPER LENGTH / FRACTIONAL SIZES
List No.531, 6531, 545P

Size	Decimal Equivalent	Flute Length	Overall Length
1/64	0.0156	5/16	1 1/2
1/32	0.0313	3/4	2
3/64	0.0469	1 1/8	2 1/4
1/16	0.0625	1 3/4	3
5/64	0.0781	2	3 3/4
3/32	0.0938	2 1/4	4 1/4
7/64	0.1094	2 1/2	4 5/8
1/8	0.1250	2 3/4	5 1/8
9/64	0.1406	3	5 3/8
5/32	0.1563	3	5 3/8
11/64	0.1719	3 3/8	5 3/4
3/16	0.1875	3 3/8	5 3/4
13/64	0.2031	3 5/8	6
7/32	0.2188	3 5/8	6
15/64	0.2344	3 3/4	6 1/8
1/4	0.2500	3 3/4	6 1/8
17/64	0.2656	3 7/8	6 1/4
9/32	0.2813	3 7/8	6 1/4
19/64	0.2969	4	6 3/8
5/16	0.3125	4	6 3/8
21/64	0.3281	4 1/8	6 1/2
11/32	0.3438	4 1/8	6 1/2
23/64	0.3594	4 1/4	6 3/4
3/8	0.3750	4 1/4	6 3/4
25/64	0.3906	4 3/8	7
13/32	0.4063	4 3/8	7
27/64	0.4219	4 5/8	7 1/4
7/16	0.4375	4 5/8	7 1/4
29/64	0.4531	4 3/4	7 1/2
15/32	0.4688	4 3/4	7 1/2
31/64	0.4844	4 3/4	7 3/4
1/2	0.5000	4 3/4	7 3/4
33/64	0.5156	4 3/4	8
17/32	0.5313	4 3/4	8
35/64	0.5469	4 7/8	8 1/4
9/16	0.5625	4 7/8	8 1/4
37/64	0.5781	4 7/8	8 3/4
19/32	0.5938	4 7/8	8 3/4
39/64	0.6094	4 7/8	8 3/4
5/8	0.6250	4 7/8	8 3/4
41/64	0.6406	5 1/8	9
21/32	0.6563	5 1/8	9
43/64	0.6719	5 3/8	9 1/4
11/16	0.6875	5 3/8	9 1/4
45/64	0.7031	5 5/8	9 1/2
23/32	0.7188	5 5/8	9 1/2
47/64	0.7344	5 7/8	9 3/4
3/4	0.7500	5 7/8	9 3/4

Sizes to 1/64 to 5/16 in package of 10; 21/64 to 1/2 in package of 5

Technical Data

DRILLS

DRILLS
Cutting Condition

END MILLS

END MILLS
Cutting Condition

TAPS

TAPS
Cutting Condition

Others

STRAIGHT SHANK DRILL-EXTRA LENGTH

Technical Data

List No.551

HIGH SPEED STEEL Bright Finish



Range 1/8 to 1"
Overall Length 12" And 18"



Used in general deep hole drilling.

DRILLS

DRILLS Cutting Condition

END MILLS

END MILLS Cutting Condition

TAPS

TAPS Cutting Condition

Others

Size	Decimal Equivalent	Overall Length	
		12"	18"
		Flute Length	Flute Length
1/8	0.1250	9	—
9/64	0.1406	9	—
5/32	0.1563	9	—
11/64	0.1719	9	—
3/16	0.1875	9	14
13/64	0.2031	9	14
7/32	0.2188	9	14
15/64	0.2344	9	14
1/4	0.2500	9	14
17/64	0.2656	9	14
9/32	0.2813	9	14
19/64	0.2969	9	14
5/16	0.3125	9	14
21/64	0.3281	9	14
11/32	0.3438	9	14
23/64	0.3594	9	14
3/8	0.3750	9	14
25/64	0.3906	9	14
13/32	0.4063	9	14
27/64	0.4219	9	14
7/16	0.4375	9	14

Size	Decimal Equivalent	Overall Length	
		12"	18"
		Flute Length	Flute Length
29/64	0.4531	9	14
15/32	0.4688	9	14
31/64	0.4844	9	14
1/2	0.5000	9	14
33/64	0.5156	9	14
17/32	0.5313	9	14
35/64	0.5469	9	14
9/16	0.5625	9	14
37/64	0.5781	9	14
19/32	0.5938	9	14
39/64	0.6094	9	14
5/8	0.6250	9	14
21/32	0.6563	9	14
11/16	0.6875	9	14
23/32	0.7188	9	14
3/4	0.7500	9	14
13/16	0.8125	9	14
7/8	0.8750	9	14
15/16	0.9375	9	14
1	1.0000	9	14

1 per box

List No.6551

Parabolic Tang Drive

HIGH SPEED STEEL COBALT Black Oxide



Range 3/16 to 1/2
Overall Length 10"



Used in deep hole drilling for tougher high tensile materials.

Size	Decimal Equivalent	Flute Length	Overall Length
3/16	0.1875	7	10
13/64	0.2031	7	10
7/32	0.2188	7	10
15/64	0.2344	7	10
1/4	0.2500	7	10
17/64	0.2656	7	10
9/32	0.2813	7	10
19/64	0.2969	7	10
5/16	0.3125	7	10
21/64	0.3281	7	10
11/32	0.3438	7	10

Size	Decimal Equivalent	Flute Length	Overall Length
23/64	0.3594	7	10
3/8	0.3750	7	10
25/64	0.3906	7	10
13/32	0.4063	7	10
27/64	0.4219	7	10
7/16	0.4375	7	10
29/64	0.4531	7	10
15/32	0.4688	7	10
31/64	0.4844	7	10
1/2	0.5000	7	10

1 per box

List No.581



Range 3/8 to 1 1/2

M35 COBALT Bright Finish



Used in heavy-duty applications. Delivers coolant to the point permit higher speeds and feeds and reduce high temperatures.

Size	Decimal Equivalent	Flute Length	Overall Length
3/8	0.3750	4 1/4	6 3/4
25/64	0.3906	4 3/8	7
13/32	0.4063	4 3/8	7
27/64	0.4219	4 5/8	7 1/4
7/16	0.4375	4 5/8	7 1/4
29/64	0.4531	4 7/8	7 1/2
15/32	0.4688	4 7/8	7 1/2
31/64	0.4844	5	7 3/4
1/2	0.5000	5	7 3/4
33/64	0.5156	5 1/4	8
17/32	0.5313	5 1/4	8
35/64	0.5469	5 3/8	8 1/4
9/16	0.5625	5 3/8	8 1/4
37/64	0.5781	5 5/8	8 1/2
19/32	0.5938	5 5/8	8 1/2
39/64	0.6094	5 3/4	8 3/4
5/8	0.6250	5 3/4	8 3/4
41/64	0.6406	5 7/8	9
21/32	0.6563	5 7/8	9
43/64	0.6719	6	9 1/4
11/16	0.6875	6	9 1/4
45/64	0.7031	6 3/16	9 1/2
23/32	0.7188	6 3/16	9 1/2
47/64	0.7344	6 3/8	9 3/4
3/4	0.7500	6 3/8	9 3/4
49/64	0.7656	6 1/2	9 7/8
25/32	0.7813	6 1/2	9 7/8
51/64	0.7969	6 5/8	10

Size	Decimal Equivalent	Flute Length	Overall Length
13/16	0.8125	6 5/8	10
53/64	0.8281	6 3/4	10 1/4
27/32	0.8438	6 3/4	10 1/4
55/64	0.8594	7	10 1/2
7/8	0.8750	7	10 1/2
57/64	0.8906	7	10 5/8
29/32	0.9063	7	10 5/8
59/64	0.9219	7	10 3/4
15/16	0.9375	7	10 3/4
61/64	0.9531	7 1/8	10 7/8
31/32	0.9688	7 1/8	10 7/8
63/64	0.9844	7 3/16	11
1	1.0000	7 3/16	11
1 1/64	1.0156	7 5/16	11 1/8
1 1/32	1.0313	7 5/16	11 1/8
1 3/64	1.0469	7 3/8	11 1/4
1 1/16	1.0625	7 3/8	11 1/4
1 3/32	1.0938	7 5/8	11 1/2
1 1/8	1.1250	7 7/8	11 3/4
1 5/32	1.1563	8	11 7/8
1 3/16	1.1875	8 1/8	12
1 7/32	1.2188	8 1/8	12 1/8
1 1/4	1.2500	8 1/2	12 1/2
1 5/16	1.3125	9 1/4	14 1/4
1 3/8	1.3750	9 1/2	14 1/2
1 7/16	1.4375	9 5/8	14 3/4
1 1/2	1.5000	9 7/8	15

1 per box

Technical Data

DRILLS

DRILLS Cutting Condition

END MILLS

END MILLS Cutting Condition

TAPS

TAPS Cutting Condition

Others

TAPER SHANK DRILLS / REGULAR SHANKS / FRACTIONAL

List No.601 General Purpose

HIGH SPEED STEEL Black Oxide



Range 1/8" to 3 1/2"



Used in cast iron, steel, forgings, and other materials.

Technical Data

DRILLS

DRILLS Cutting Condition

END MILLS

END MILLS Cutting Condition

TAPS

TAPS Cutting Condition

Others

	Size	Decimal Equivalent	Flute Length	Overall Length	Taper Shank
*	1/8	0.1250	1 7/8	5 1/8	1
*	9/64	0.1406	2 1/8	5 3/8	1
*	5/32	0.1563	2 1/8	5 3/8	1
*	11/64	0.1719	2 1/2	5 3/4	1
*	3/16	0.1875	2 1/2	5 3/4	1
*	13/64	0.2031	2 3/4	6	1
*	7/32	0.2188	2 3/4	6	1
*	15/64	0.2344	2 7/8	6 1/8	1
*	1/4	0.2500	2 7/8	6 1/8	1
*	17/64	0.2656	3	6 1/4	1
	9/32	0.2813	3	6 1/4	1
	19/64	0.2969	3 1/8	6 3/8	1
	5/16	0.3125	3 1/8	6 3/8	1
	21/64	0.3281	3 1/4	6 1/2	1
	11/32	0.3438	3 1/4	6 1/2	1
	23/64	0.3594	3 1/2	6 3/4	1
	3/8	0.3750	3 1/2	6 3/4	1
	25/64	0.3906	3 5/8	7	1
	13/32	0.4063	3 5/8	7	1
	27/64	0.4219	3 7/8	7 1/4	1
	7/16	0.4375	3 7/8	7 1/4	1
	29/64	0.4531	4 1/8	7 1/2	1
	15/32	0.4688	4 1/8	7 1/2	1
	31/64	0.4844	4 3/8	8 1/4	2
	1/2	0.5000	4 3/8	8 1/4	2
	33/64	0.5156	4 5/8	8 1/2	2
	17/32	0.5313	4 5/8	8 1/2	2
	35/64	0.5469	4 7/8	8 3/4	2
	9/16	0.5625	4 7/8	8 3/4	2
	37/64	0.5781	4 7/8	8 3/4	2
	19/32	0.5938	4 7/8	8 3/4	2
	39/64	0.6094	4 7/8	8 3/4	2
	5/8	0.6250	4 7/8	8 3/4	2
	41/64	0.6406	5 1/8	9	2
	21/32	0.6563	5 1/8	9	2
	43/64	0.6719	5 3/8	9 1/4	2
	11/16	0.6875	5 3/8	9 1/4	2
	45/64	0.7031	5 5/8	9 1/2	2
	23/32	0.7188	5 5/8	9 1/2	2
	47/64	0.7344	5 7/8	9 3/4	2
	3/4	0.7500	5 7/8	9 3/4	2
	49/64	0.7656	6	9 7/8	2
	25/32	0.7813	6	9 7/8	2
	51/64	0.7969	6 1/8	10 3/4	3
	13/16	0.8125	6 1/8	10 3/4	3
	53/64	0.8281	6 1/8	10 3/4	3
	27/32	0.8438	6 1/8	10 3/4	3
	55/64	0.8594	6 1/8	10 3/4	3

	Size	Decimal Equivalent	Flute Length	Overall Length	Taper Shank
	7/8	0.8750	6 1/8	10 3/4	3
	57/64	0.8906	6 1/8	10 3/4	3
	29/32	0.9063	6 1/8	10 3/4	3
	59/64	0.9219	6 1/8	10 3/4	3
	15/16	0.9375	6 1/8	10 3/4	3
	61/64	0.9531	6 3/8	11	3
	31/32	0.9688	6 3/8	11	3
	63/64	0.9844	6 3/8	11	3
	1	1.0000	6 3/8	11	3
	1 1/64	1.0156	6 1/2	11 1/8	3
	1 1/32	1.0313	6 1/2	11 1/8	3
	1 3/64	1.0469	6 5/8	11 1/4	3
	1 1/16	1.0625	6 5/8	11 1/4	3
	1 5/64	1.0781	6 7/8	12 1/2	4
	1 3/32	1.0938	6 7/8	12 1/2	4
	1 7/64	1.1094	7 1/8	12 3/4	4
	1 1/8	1.1250	7 1/8	12 3/4	4
	1 9/64	1.1406	7 1/4	12 7/8	4
	1 5/32	1.1563	7 1/4	12 7/8	4
	1 11/64	1.1719	7 3/8	13	4
	1 3/16	1.1875	7 3/8	13	4
	1 13/64	1.2031	7 1/2	13 1/8	4
	1 7/32	1.2188	7 1/2	13 1/8	4
	1 15/64	1.2344	7 7/8	13 1/2	4
	1 1/4	1.2500	7 7/8	13 1/2	4
	1 17/64	1.2656	8 1/2	14 1/8	4
	1 9/32	1.2813	8 1/2	14 1/8	4
	1 19/64	1.2969	8 5/8	14 1/4	4
	1 5/16	1.3125	8 5/8	14 1/4	4
	1 21/64	1.3281	8 3/4	14 3/8	4
	1 11/32	1.3438	8 3/4	14 3/8	4
	1 23/64	1.3594	8 7/8	14 1/2	4
	1 3/8	1.3750	8 7/8	14 1/2	4
	1 25/64	1.3906	9	14 5/8	4
	1 13/32	1.4063	9	14 5/8	4
	1 27/64	1.4219	9 1/8	14 3/4	4
	1 7/16	1.4375	9 1/8	14 3/4	4
	1 29/64	1.4531	9 1/4	14 7/8	4
	1 15/32	1.4688	9 1/4	14 7/8	4
	1 31/64	1.4844	9 3/8	15	4
	1 1/2	1.5000	9 3/8	15	4
	1 33/64	1.5156	9 3/8	16 3/8	5
	1 17/32	1.5313	9 3/8	16 3/8	5
	1 35/64	1.5469	9 5/8	16 5/8	5
	1 9/16	1.5625	9 5/8	16 5/8	5
	1 37/64	1.5781	9 7/8	16 5/8	5
	1 19/32	1.5938	9 7/8	16 7/8	5
	1 39/64	1.6094	10	17	5

	Size	Decimal Equivalent	Flute Length	Overall Length	Taper Shank
	1 5/8	1.6250	10	17	5
	1 41/64	1.6406	10 1/8	17 1/8	5
	1 21/32	1.6563	10 1/8	17 1/8	5
	1 43/64	1.6719	10 1/8	17 1/8	5
	1 11/16	1.6875	10 1/8	17 1/8	5
	1 45/64	1.7031	10 1/8	17 1/8	5
	1 23/32	1.7188	10 1/8	17 1/8	5
	1 47/64	1.7344	10 1/8	17 1/8	5
	1 3/4	1.7500	10 1/8	17 1/8	5
	1 25/32	1.7813	10 1/8	17 1/8	5
	1 13/16	1.8125	10 1/8	17 1/8	5
	1 27/32	1.8438	10 1/8	17 1/8	5
	1 7/8	1.8750	10 3/8	17 3/8	5
	1 29/32	1.9063	10 3/8	17 3/8	5
	1 15/16	1.9375	10 3/8	17 3/8	5
	1 31/32	1.9688	10 3/8	17 3/8	5
	2	2.0000	10 3/8	17 3/8	5
	2 1/32	2.0313	10 3/8	17 3/8	5
	2 1/16	2.0625	10 1/4	17 3/8	5
	2 3/32	2.0938	10 1/4	17 3/8	5
	2 1/8	2.1250	10 1/4	17 3/8	5
	2 5/32	2.1563	10 1/4	17 3/8	5
	2 3/16	2.1875	10 1/4	17 3/8	5
	2 7/32	2.2188	10 1/8	17 3/8	5
	2 1/4	2.2500	10 1/8	17 3/8	5
	2 5/16	2.3125	10 1/8	17 3/8	5
	2 3/8	2.3750	10 1/8	17 3/8	5
	2 7/16	2.4375	11 1/4	18 3/4	5
	2 1/2	2.5000	11 1/4	18 3/4	5
	2 9/16	2.5625	11 7/8	19 1/2	5
	2 5/8	2.6250	11 7/8	19 1/2	5
	2 11/16	2.6875	12 3/4	20 3/8	5
	2 3/4	2.7500	12 3/4	20 3/8	5
	2 13/16	2.8125	13 3/8	21 1/8	5
	2 7/8	2.8750	13 3/8	21 1/8	5
	2 15/16	2.9375	14	21 3/4	5
	3	3.0000	14	21 3/4	5
	3 1/16	3.0625	14 5/8	24 1/2	6
	3 1/8	3.1250	14 5/8	24 1/2	6
	3 3/16	3.1875	14 5/8	24 1/2	6
	3 1/4	3.2500	15 1/2	25 1/2	6
	3 5/16	3.3125	15 1/2	25 1/2	6
	3 3/8	3.3750	15 1/2	25 1/2	6
	3 7/16	3.4375	15 1/2	25 1/2	6
	3 1/2	3.5000	16 3/8	26 1/2	6

* item will be discontinued, after stock has depleted.

1 per box

List No.651 Taper Shank Drills

HIGH SPEED STEEL **Bright Finish**



Range 1/4 to 2 1/2
Overall Length 18" and 24"

Used for deep hole drilling with Taper Shank.

Size	Decimal Equivalent	Overall Length		Taper Shank
		18"	24"	
		Flute Length	Flute Length	
1/4	0.2500	14	—	1
17/64	0.2656	14	—	1
9/32	0.2813	14	—	1
19/64	0.2969	14	—	1
5/16	0.3125	14	20	1
21/64	0.3281	14	—	1
11/32	0.3438	14	—	1
23/64	0.3594	14	—	1
3/8	0.3750	14	20	1
25/64	0.3906	14	—	1
13/32	0.4063	14	—	1
27/64	0.4219	14	—	1
7/16	0.4375	14	20	1
29/64	0.4531	14	—	1
15/32	0.4688	14	—	1
31/64	0.4844	14	—	2
1/2	0.5000	14	20	2
33/64	0.5156	14	20	2
17/32	0.5313	14	20	2
35/64	0.5469	14	—	2
9/16	0.5625	14	20	2
37/64	0.5781	14	20	2
19/32	0.5938	14	20	2
39/64	0.6094	14	—	2
5/8	0.6250	14	20	2
41/64	0.6406	14	—	2
21/32	0.6563	14	20	2
43/64	0.6719	14	—	2
11/16	0.6875	14	20	2
45/64	0.7031	14	—	2
23/32	0.7188	14	20	2
47/64	0.7344	14	—	2
3/4	0.7500	14	20	2
49/64	0.7656	14	—	2
25/32	0.7813	14	20	2
51/64	0.7969	13	—	3
13/16	0.8125	13	19	3
53/64	0.8281	13	—	3

Size	Decimal Equivalent	Overall Length		Taper Shank
		18"	24"	
		Flute Length	Flute Length	
27/32	0.8438	13	19	3
55/64	0.8594	13	—	3
7/8	0.8750	13	19	3
57/64	0.8906	13	—	3
29/32	0.9063	13	19	3
59/64	0.9219	13	—	3
15/16	0.9375	13	19	3
61/64	0.9531	13	—	3
31/32	0.9688	13	19	3
63/64	0.9844	13	—	3
1	1.0000	13	19	3
1 1/32	1.0313	13	—	3
1 1/16	1.0625	13	19	3
1 3/32	1.0938	12	—	4
1 1/8	1.1250	12	19	4
1 5/32	1.1563	12	18	4
1 3/16	1.1875	12	18	4
1 7/32	1.2188	12	18	4
1 1/4	1.2500	12	18	4
1 9/32	1.2813	12	—	4
1 5/16	1.3125	12	18	4
1 11/32	1.3438	12	—	4
1 3/8	1.3750	12	18	4
1 13/32	1.4063	12	—	4
1 7/16	1.4375	12	18	4
1 1/2	1.5000	12	18	4
1 9/16	1.5625	10 1/2	17	5
1 5/8	1.6250	10 1/2	17	5
1 11/16	1.6875	10 1/2	17	5
1 3/4	1.7500	10 1/2	17	5
1 7/8	1.8750	10 1/2	17	5
2	2.0000	10 1/2	17	5
2 1/16	2.0625	—	17	5
2 1/8	2.1250	—	17	5
2 1/4	2.2500	—	17	5
2 3/8	2.3750	—	17	5
2 1/2	2.5000	—	17	5

1 per box

Technical Data

DRILLS

DRILLS
Cutting Condition

END MILLS

END MILLS
Cutting Condition

TAPS

TAPS
Cutting Condition

Others

List No.683



Range 3/8 to 1 1/2

M35 COBALT Bright Finish



Used in heavy-duty applications. Delivers coolant to the point permit higher speeds and feeds and reduce high temperatures.

Size	Decimal Equivalent	Flute Length	Overall Length	Shank Taper
3/8	0.3750	4 1/4	8 1/8	2
25/64	0.3906	4 3/8	8 1/4	2
13/32	0.4063	4 3/8	8 1/4	2
27/64	0.4219	4 5/8	8 1/2	2
7/16	0.4375	4 5/8	8 1/2	2
29/64	0.4531	4 7/8	8 3/4	2
15/32	0.4688	4 7/8	8 3/4	2
31/64	0.4844	5	9 5/8	3
1/2	0.5000	5	9 5/8	3
33/64	0.5156	5 1/8	9 3/4	3
17/32	0.5313	5 1/8	9 3/4	3
35/64	0.5469	5 1/4	9 7/8	3
9/16	0.5625	5 1/4	9 7/8	3
37/64	0.5781	5 1/2	10 1/8	3
19/32	0.5938	5 1/2	10 1/8	3
39/64	0.6094	5 5/8	10 1/4	3
5/8	0.6250	5 5/8	10 1/4	3
41/64	0.6406	5 3/4	10 3/8	3
21/32	0.6563	5 3/4	10 3/8	3
43/64	0.6719	5 7/8	10 1/2	3
11/16	0.6875	5 7/8	10 1/2	3
45/64	0.7031	6 1/8	10 3/4	3
23/32	0.7188	6 1/8	10 3/4	3
47/64	0.7344	6 1/4	10 7/8	3
3/4	0.7500	6 1/4	10 7/8	3

Size	Decimal Equivalent	Flute Length	Overall Length	Shank Taper
49/64	0.7656	6 3/8	11	3
25/32	0.7813	6 3/8	11	3
51/64	0.7969	6 1/2	11 1/8	3
13/16	0.8125	6 1/2	11 1/8	3
53/64	0.8281	6 5/8	11 1/4	3
27/32	0.8438	6 5/8	11 1/4	3
55/64	0.8594	6 7/8	11 1/2	3
7/8	0.8750	6 7/8	11 1/2	3
57/64	0.8906	6 7/8	11 1/2	3
29/32	0.9063	6 7/8	11 1/2	3
59/64	0.9219	6 7/8	11 1/2	3
15/16	0.9375	6 7/8	11 1/2	3
61/64	0.9531	7	11 5/8	3
31/32	0.9688	7	11 5/8	3
63/64	0.9844	7 1/8	11 3/4	3
1	1.0000	7 1/8	11 3/4	3
1 1/16	1.0625	7 1/4	12 7/8	4
1 1/8	1.1250	7 3/4	13 3/8	4
1 3/16	1.1875	8	13 5/8	4
1 1/4	1.2500	8 1/4	13 7/8	4
1 5/16	1.3125	9 1/8	14 3/4	4
1 3/8	1.3750	9 3/8	15	4
1 7/16	1.4375	9 1/2	15 1/8	4
1 1/2	1.5000	9 3/4	15 3/8	4

1 per box

Technical Data

DRILLS

DRILLS Cutting Condition

END MILLS

END MILLS Cutting Condition

TAPS

TAPS Cutting Condition

Others

List No.575



Shank Diameter 1/2" by 2 1/2" long
Range 1/2" to 1 1/2"

HIGH SPEED STEEL Bright Finish



Used for general purpose drilling when 1/2" shank is required.
Used in drill presses and portable electric drills.

Size	Decimal Equivalent	Flute Length	Overall Length
1/2	.5000	3 1/8	6
33/64	.5156	3 1/8	6
17/32	.5312	3 1/8	6
35/64	.5469	3 1/8	6
9/16	.5625	3 1/8	6
37/64	.5781	3 1/8	6
19/32	.5938	3 1/8	6
39/64	.6094	3 1/8	6
5/8	.6250	3 1/8	6
41/64	.6406	3 1/8	6
21/32	.6562	3 1/8	6
43/64	.6719	3 1/8	6
11/16	.6875	3 1/8	6
45/64	.7031	3 1/8	6
23/32	.7187	3 1/8	6
47/64	.7344	3 1/8	6
3/4	.7500	3 1/8	6
49/64	.7656	3	6
25/32	.7812	3	6
51/64	.7969	3	6
13/16	.8125	3	6
53/64	.8281	3	6
27/32	.8438	3	6
55/64	.8594	3	6
7/8	.8750	6	6

Size	Decimal Equivalent	Flute Length	Overall Length
57/64	.8906	3	6
29/32	.9062	3	6
59/64	.9219	3	6
15/16	.9375	3	6
61/64	.9531	3	6
31/32	.9687	3	6
63/64	.9844	3	6
1	1.0000	3	6
1 1/32	1.0312	3	6
1 1/16	1.0625	3	6
1 3/32	1.0938	3	6
1 1/8	1.1250	3	6
1 5/32	1.1562	3	6
1 3/16	1.1875	3	6
1 7/32	1.2188	3	6
1 1/4	1.2500	3	6
1 9/32	1.2812	2 3/4	6
1 5/16	1.3125	2 3/4	6
1 11/32	1.3438	2 3/4	6
1 3/8	1.3750	2 3/4	6
1 13/32	1.4062	2 3/4	6
1 7/16	1.4375	2 3/4	6
1 15/32	1.4688	2 3/4	6
1 1/2	1.5000	2 3/4	6

1 per box

Technical Data

DRILLS

DRILLS Cutting Condition

END MILLS

END MILLS Cutting Condition

TAPS

TAPS Cutting Condition

Others

Technical
Data

DRILLS

DRILLS
Cutting Condition

END MILLS

END MILLS
Cutting Condition

TAPS

TAPS
Cutting Condition

Others

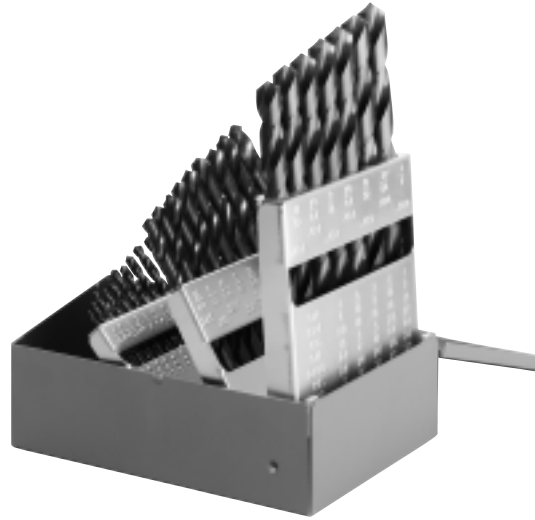
List No.599 General Purpose**Black Oxide**

HIGH SPEED DRILLS SETS (L501, L501A)	SET NO.
Fractional Sizes	
1/16" To 1/4" By 64ths	S13
1/16" To 1/2" By 32nds	S15
1/16" To 3/8" By 64ths	S21
1/16" To 1/2" By 64ths	S29
Wire Gauge Sizes	
No.1 To No.60	S60
No.61 To No. 80	S20
Letter Sizes	
A To Z	S26
Combination Sizes	
S29, S60, S26	S115
COBALT DRILL SETS (L6501)	SET NO.
Fractional Sizes	
1/16" To 1/2" By 64ths	C29

STANDARD DRILLING CONDITION

SG-ESS Drills List No. 7572P, 7573P

Workpiece Material			Structural Steels, Carbon Steels		Alloy Steels		Mold Steels Stainless Steels 300-400 series		Nickel Alloys, Titanium Alloys		Cast Irons		Aluminum Alloys, Copper Alloys, Nonferrous Alloys	
Speed (SFM)			115 - 135 SFM		95 - 105 SFM		40 - 50 SFM		20 SFM		130 - 150 SFM		200 - 230 SFM	
Drill Diameter			115 - 135 SFM		95 - 105 SFM		40 - 50 SFM		20 SFM		130 - 150 SFM		200 - 230 SFM	
Fractional	Metric mm	Decimal	RPM	Feed (IPR)	RPM	Feed (IPR)	RPM	Feed (IPR)	RPM	Feed (IPR)	RPM	Feed (IPR)	RPM	Feed (IPR)
—	2	0.0787	6,000	0.003	4,800	0.002	2,100	0.002	950	0.001	6,800	0.003	10,500	0.003
3/32	2.381	0.0938	5,000	0.003	4,000	0.003	1,800	0.003	800	0.001	5,700	0.004	8,700	0.004
—	3	0.1181	4,000	0.004	3,200	0.004	1,500	0.004	650	0.001	4,500	0.005	7,000	0.005
1/8	3.175	0.1250	3,800	0.005	3,000	0.004	1,400	0.004	600	0.002	4,250	0.006	6,500	0.006
5/32	3.969	0.1563	3,000	0.006	2,400	0.005	1,100	0.004	500	0.002	3,400	0.007	5,200	0.007
3/16	4.763	0.1875	2,500	0.007	2,000	0.005	900	0.004	400	0.002	2,850	0.008	4,300	0.008
—	5	0.1969	2,500	0.007	1,900	0.006	850	0.004	350	0.002	2,700	0.008	4,100	0.008
1/4	6.35	0.2500	1,900	0.008	1,500	0.007	700	0.005	300	0.003	2,100	0.010	3,200	0.009
5/16	7.938	0.3125	1,500	0.009	1,200	0.008	550	0.007	250	0.003	1,750	0.012	2,600	0.011
—	8	0.3150	1,500	0.009	1,200	0.008	550	0.007	250	0.003	1,700	0.012	2,600	0.012
3/8	9.525	0.3750	1,250	0.010	1,000	0.009	450	0.008	200	0.004	1,450	0.012	2,200	0.013
—	10	0.3937	1,200	0.010	950	0.009	450	0.008	200	0.004	1,400	0.013	2,100	0.013
—	12	0.4724	1,000	0.011	800	0.010	350	0.009	150	0.005	1,100	0.014	1,700	0.015
1/2	12.7	0.5000	950	0.011	750	0.010	350	0.009	150	0.005	1,100	0.015	1,650	0.015
—	16	0.6299	750	0.014	600	0.012	250	0.011	120	0.007	850	0.017	1,300	0.017
—	20	0.7874	600	0.016	450	0.014	200	0.012	100	0.008	680	0.020	1,050	0.020
—	25	0.9843	450	0.019	350	0.015	150	0.014	70	0.010	550	0.023	850	0.023
—	32	1.2598	350	0.018	300	0.015	150	0.016	50	0.014	450	0.022	650	0.022

- 1) The above values apply when coolant is used in vertical machine & horizontal machine. When drilling in stainless steel and hard to cut material using pecking.
- 2) Adjust drilling condition when unusual vibration or different sound occurs.
- 3) Recommended feeds and speeds are starting points only. Actual performance will be determined by specific material, the condition of equipment being used and coolant.

Formulas: $RPM = \frac{SFM \times 3.82}{\text{Drill dia.}}$, Feed Rate (in/min) = RPM x IPR

SG-ES Drills List No. 7570P, 7571P

Workpiece Material			Structural Steels, Carbon Steels		Alloy Steels		Die Steels Steels(35-45HRc) 400 Series Stainless Steel		Cast Irons		Aluminum Alloys, Copper Alloys, Nonferrous Alloys	
Speed (SFM)			115 - 135 SFM		95 - 105 SFM		40 - 50 SFM		130 - 150 SFM		200 - 230 SFM	
Drill Diameter			115 - 135 SFM		95 - 105 SFM		40 - 50 SFM		130 - 150 SFM		200 - 230 SFM	
Fractional	Metric mm	Decimal	RPM	Feed (IPR)	RPM	Feed (IPR)	RPM	Feed (IPR)	RPM	Feed (IPR)	RPM	Feed (IPR)
—	2	0.0787	6,000	0.003	4,800	0.002	2,200	0.002	6,800	0.003	10,400	0.003
3/32	2.381	0.0938	5,100	0.003	4,000	0.003	1,800	0.003	5,700	0.004	8,700	0.004
—	3	0.1181	4,100	0.004	3,200	0.004	1,450	0.004	4,500	0.005	6,900	0.005
1/8	3.175	0.1250	3,800	0.005	3,100	0.004	1,375	0.004	4,300	0.006	6,570	0.006
5/32	3.969	0.1563	3,100	0.006	2,450	0.005	1,100	0.004	3,450	0.007	5,300	0.007
3/16	4.763	0.1875	2,550	0.007	2,000	0.005	900	0.004	2,900	0.008	4,400	0.008
—	5	0.1969	2,400	0.007	1,900	0.006	870	0.004	2,700	0.008	4,200	0.008
1/4	6.35	0.2500	1,900	0.008	1,500	0.007	700	0.005	2,100	0.010	3,300	0.009
5/16	7.938	0.3125	1,500	0.009	1,200	0.008	550	0.007	1,750	0.012	2,700	0.011
—	8	0.3150	1,500	0.009	1,200	0.008	550	0.007	1,700	0.012	2,600	0.012
3/8	9.525	0.3750	1,300	0.010	1,000	0.009	500	0.008	1,500	0.012	2,200	0.013
—	10	0.3937	1,200	0.010	950	0.009	450	0.008	1,400	0.013	2,100	0.013
—	12	0.4724	1,000	0.011	800	0.010	400	0.009	1,100	0.014	1,750	0.015
1/2	12.7	0.5000	950	0.011	750	0.010	350	0.009	1,050	0.015	1,650	0.015
—	16	0.6299	750	0.014	600	0.012	300	0.011	850	0.017	1,300	0.017
—	20	0.7874	600	0.016	500	0.014	250	0.012	700	0.020	1,050	0.020
—	25	0.9843	500	0.019	400	0.015	200	0.014	550	0.023	850	0.023
—	32	1.2598	400	0.018	300	0.015	150	0.016	450	0.022	650	0.022

- 1) SG-ES is not recommended for 300-series Stainless Steels.
- 2) SG-ES is suitable for drilling into 400-series Stainless Steels.
- 3) Pilot hole required for deep hole drilling applications. It is recommended to use same diameter pilot drill. The depth of cut for pilot hole is 1 to 2 times drill diameter.
- 4) Use pecking in hard to cut materials.
- 5) Recommended feeds and speeds are starting points only. Actual performance will be determined by specific material, the condition of equipment being used and coolant.

Formulas: $RPM = \frac{SFM \times 3.82}{\text{Drill dia.}}$, Feed Rate (in/min) = RPM x IPR

Technical Data

DRILLS

DRILLS Cutting Condition

END MILLS

END MILLS Cutting Condition

TAPS

TAPS Cutting Condition

Others

SG Drills with Oil Hole List No. 7596P, 7591P

Workpiece Material			Structural Steels, Carbon Steels		Alloy Steels		Die Steels Hardened Steels (35-45HRc)		Stainless Steels		Cast Irons		Aluminum Alloys, Copper Alloys, Nonferrous Alloys	
Speed (SFM)			120 - 130 SFM		105 - 110 SFM		40 - 50 SFM		60 - 70 SFM		130 - 150 SFM		200 - 230 SFM	
Drill Diameter			120 - 130 SFM		105 - 110 SFM		40 - 50 SFM		60 - 70 SFM		130 - 150 SFM		200 - 230 SFM	
Fractional	Metric mm	Decimal	RPM	Feed (IPR)	RPM	Feed (IPR)	RPM	Feed (IPR)	RPM	Feed (IPR)	RPM	Feed (IPR)	RPM	Feed (IPR)
—	5	0.1969	2,400	0.007	1,900	0.006	850	0.005	1,200	0.005	2,700	0.009	4,100	0.009
1/4	6.35	0.2500	1,900	0.008	1,500	0.008	650	0.006	1,000	0.006	2,100	0.011	3,300	0.011
5/16	7.938	0.3125	1,500	0.009	1,250	0.008	550	0.007	800	0.007	1,700	0.013	2,650	0.013
—	8	0.3150	1,500	0.009	1,200	0.009	550	0.009	750	0.008	1,700	0.014	2,600	0.014
3/8	9.525	0.3750	1,250	0.010	1,000	0.010	500	0.009	700	0.009	1,500	0.014	2,200	0.014
—	10	0.3937	1,200	0.010	950	0.011	450	0.010	650	0.010	1,400	0.016	2,000	0.016
—	12	0.4724	1,000	0.011	800	0.011	400	0.010	550	0.010	1,200	0.016	1,700	0.016
1/2	12.7	0.5000	950	0.011	750	0.013	350	0.012	500	0.013	1,100	0.019	1,600	0.019
—	16	0.6299	750	0.014	600	0.014	250	0.014	400	0.015	850	0.021	1,300	0.021
—	20	0.7874	600	0.016	450	0.015	200	0.014	300	0.015	650	0.022	1,000	0.021

- 1) The above values apply when coolant is used in vertical machine & horizontal machine. When drilling in stainless steel and hard to cut material using pecking.
- 2) Adjust drilling condition when unusual vibration or different sound occurs.
- 3) Recommended feeds and speeds are starting points only. Actual performance will be determined by specific material, the condition of equipment being used and coolant.

Formulas: $RPM = \frac{SFM \times 3.82}{\text{Drill dia.}}$, Feed Rate (in/min) = RPM x IPR

UG-Power Drills List No. 6528P, 6517U

Workpiece Material			Structural Steels, Carbon Steels		Alloy Steels		Die Steels Hardened Steels (-40HRc)		Cast Irons		Stainless Steels 300 - 400 Series	
Speed (SFM)			75 - 100 SFM		60 - 80 SFM		45 - 60 SFM		90 - 120 SFM		30 - 40 SFM	
Drill Diameter			75 - 100 SFM		60 - 80 SFM		45 - 60 SFM		90 - 120 SFM		30 - 40 SFM	
Fractional	Metric mm	Decimal	RPM	Feed (IPR)	RPM	Feed (IPR)	RPM	Feed (IPR)	RPM	Feed (IPR)	RPM	Feed (IPR)
—	1	0.0394	8,200	0.001	6,800	0.001	4,850	0.001	9,700	0.002	2,900	0.0006
3/64	1.191	0.0469	6,900	0.002	5,700	0.001	4,100	0.001	8,100	0.002	2,400	0.0008
—	2	0.0787	4,100	0.003	3,400	0.002	2,500	0.002	4,800	0.003	1,400	0.0015
3/32	2.381	0.0938	3,400	0.003	2,800	0.003	2,000	0.003	4,000	0.004	1,200	0.0017
—	3	0.1181	2,700	0.004	2,300	0.004	1,600	0.004	3,200	0.005	950	0.002
1/8	3.175	0.1250	2,500	0.005	2,100	0.004	1,500	0.004	3,000	0.006	900	0.002
5/32	3.969	0.1563	2,000	0.006	1,700	0.005	1,200	0.004	2,500	0.007	700	0.003
3/16	4.763	0.1875	1,700	0.007	1,400	0.005	1,000	0.004	2,000	0.008	600	0.003
—	5	0.1969	1,650	0.007	1,300	0.006	950	0.004	1,900	0.008	550	0.004
1/4	6.35	0.2500	1,300	0.008	1,000	0.007	750	0.005	1,500	0.010	450	0.004
5/16	7.938	0.3125	1,000	0.009	900	0.008	600	0.007	1,300	0.012	400	0.005
—	8	0.3150	1,000	0.009	850	0.008	600	0.007	1,200	0.012	400	0.005
3/8	9.525	0.3750	900	0.010	750	0.009	500	0.008	1,100	0.012	350	0.006
—	10	0.3937	850	0.010	700	0.009	450	0.008	1,000	0.013	350	0.006
13/32	10.319	0.4063	800	0.015	650	0.012	450	0.008	950	0.016	330	0.006
7/16	11.113	0.4375	750	0.015	600	0.013	400	0.009	900	0.017	300	0.007
—	12	0.4724	700	0.011	550	0.010	400	0.009	850	0.014	280	0.007
1/2	12.7	0.5000	650	0.011	550	0.010	380	0.009	800	0.015	280	0.007
—	13	0.5118	600	0.016	500	0.014	350	0.010	750	0.017	250	0.008

- 1) Pilot Hole is required. It is recommended to use same diameter or up to 0.1mm larger than diameter of the long drill. The depth of cut of the pilot hole is 1 to 2 times diameter of the drill diameter.
- 2) Use pecking in hard to cut materials like Stainless Steel & hardened Steels.
- 3) Recommended feeds and speeds are starting points only. Actual performance will be determined by specific material, the condition of equipment being used and coolant.

Formulas: $RPM = \frac{SFM \times 3.82}{\text{Drill dia.}}$, Feed Rate (in/min) = RPM x IPR

Technical Data

DRILLS

DRILLS Cutting Condition

END MILLS

END MILLS Cutting Condition

TAPS

TAPS Cutting Condition

Others

STANDARD DRILLING CONDITION

AG-SUS Short Drills List No. 6596P
AG-SUS Regular Drills List No. 6594P, 6595P

Workpiece Material			Austenitic Stainless Steels 304, 316		Austenitic Stainless Steels 304N		Martensitic Stainless Steels 420, 440		Ferritic Stainless Steels 405, 430		Low Carbon Steels	
Speed (SFM)			40 - 50 SFM		30 - 40 SFM		50 - 60 SFM		50 - 65 SFM		100 - 115 SFM	
Drill Diameter			RPM	Feed (IPR)	RPM	Feed (IPR)	RPM	Feed (IPR)	RPM	Feed (IPR)	RPM	Feed (IPR)
Fractional	Metric mm	Decimal										
—	1	0.0394	4,300	0.001	3,300	0.001	5,300	0.001	5,300	0.001	10,600	0.001
—	2	0.0787	2,100	0.003	1,700	0.002	2,650	0.002	2,650	0.001	5,300	0.003
3/32	2.381	0.0938	1,800	0.003	1,400	0.003	2,240	0.003	2,240	0.001	4,450	0.004
—	3	0.1181	1,400	0.004	1,100	0.004	1,770	0.004	1,750	0.001	3,500	0.005
1/8	3.175	0.1250	1,300	0.005	1,000	0.004	1,680	0.004	1,650	0.002	3,300	0.006
5/32	3.969	0.1563	1,100	0.006	850	0.005	1,340	0.004	1,340	0.002	2,650	0.007
3/16	4.763	0.1875	900	0.007	700	0.005	1,120	0.004	1,120	0.002	2,250	0.008
—	5	0.1969	850	0.007	670	0.006	1,050	0.004	1,060	0.002	2,100	0.008
1/4	6.35	0.2500	650	0.008	530	0.007	840	0.005	840	0.003	1,680	0.010
5/16	7.938	0.3125	550	0.009	420	0.008	670	0.007	650	0.003	1,350	0.012
—	8	0.3150	550	0.009	400	0.008	650	0.007	650	0.003	1,300	0.012
3/8	9.525	0.3750	450	0.010	350	0.009	560	0.008	560	0.004	1,100	0.012
—	10	0.3937	430	0.010	340	0.009	530	0.008	500	0.004	1,000	0.013
—	12	0.4724	360	0.011	280	0.010	440	0.009	450	0.005	850	0.014
1/2	12.7	0.5000	340	0.011	260	0.010	420	0.009	420	0.005	800	0.015
—	16	0.6299	270	0.014	210	0.012	330	0.011	330	0.007	650	0.017
3/4	19.05	0.7500	220	0.016	200	0.015	280	0.016	280	0.016	550	0.015
—	20	0.7874	210	0.016	170	0.014	260	0.012	250	0.008	500	0.020

- 1) The above values apply when coolant is used in vertical machine & horizontal machine.
- 2) Adjust drilling condition when unusual vibration or different sound occurs.
- 3) Recommended feeds and speeds are starting points only. Actual performance will be determined by specific material, the condition of equipment being used and coolant.

Formulas: $RPM = \frac{SFM \times 3.82}{\text{Drill dia.}}$, Feed Rate (in/min) = RPM x IPR

AG-Power Long Drills List No. 6540P, 6541P

Workpiece Material			Structural Steels, Carbon Steels		Alloy Steels		Hardened Steels, (-40 HRc), Tool Steels		Stainless Steels 300-400 Series		Cast Irons	
Speed (SFM)			40 - 80 SFM		25 - 50 SFM		16 - 35 SFM		30 - 40 SFM		42 - 82 SFM	
Drill Diameter			RPM	Feed (IPR)	RPM	Feed (IPR)	RPM	Feed (IPR)	RPM	Feed (IPR)	RPM	Feed (IPR)
Fractional	Metric mm	Decimal										
—	1	0.0394	5,800	0.0007	3,300	0.0007	2,400	0.0005	2,900	0.0006	6,000	0.0008
—	2	0.0787	2,900	0.002	1,600	0.002	1,200	0.002	1,400	0.0015	3,000	0.002
—	3	0.1181	1,950	0.003	1,100	0.003	800	0.002	950	0.002	2,000	0.003
1/8	3.175	0.1250	1,800	0.003	1,000	0.003	750	0.002	900	0.002	1,800	0.003
3/16	4.763	0.1875	1,200	0.005	700	0.005	500	0.004	600	0.003	1,200	0.005
—	5	0.1969	1,100	0.005	650	0.005	480	0.004	550	0.004	1,200	0.006
—	6	0.2362	970	0.006	550	0.006	400	0.005	450	0.004	1,000	0.007
1/4	6.350	0.2500	900	0.006	500	0.006	350	0.005	450	0.004	950	0.008
9/32	7.144	0.2813	800	0.007	450	0.007	350	0.005	400	0.005	850	0.009
5/16	7.938	0.3125	700	0.008	400	0.008	300	0.006	350	0.006	800	0.010
—	8	0.3150	700	0.008	400	0.008	300	0.006	350	0.006	750	0.009
23/64	9	0.3594	650	0.009	350	0.009	250	0.007	300	0.007	700	0.010
—	10	0.3937	600	0.010	350	0.009	250	0.008	300	0.007	650	0.013
—	13	0.5118	550	0.009	300	0.009	200	0.008	250	0.008	600	0.011

- 1) Pilot Hole is required. It is recommended to use same diameter or up to 0.1mm larger than diameter of the long drill. The depth of cut of the pilot hole is 1 to 2 times diameter of the drill diameter.
- 2) Above drilling table is applied to Series 1 & 2. In case of series 3 & 4, reduce the RPM and feed to 80% of table values.
- 3) Use pecking when drilling in Stainless Steel & Hardened Steels.
- 4) Recommended feeds and speeds are starting points only. Actual performance will be determined by specific material, the condition of equipment being used and coolant.

Formulas: $RPM = \frac{SFM \times 3.82}{\text{Drill dia.}}$, Feed Rate (in/min) = RPM x IPR

Technical Data

DRILLS

DRILLS Cutting Condition

END MILLS

END MILLS Cutting Condition

TAPS

TAPS Cutting Condition

Others

AQUA Drills STUB List No. 9550, 9551

Hi-Speed Wet Drilling

Workpiece Material			Carbon Steels Cast Irons		Alloy Steels		Die Steels Hardened Steels (30-40HRc)		Hardened Steels (40-50HRc)		DuctileCast Irons	
Speed (SFM)			330 - 495 SFM		260 - 330 SFM		165 - 230 SFM		100 - 165 SFM		260 - 330 SFM	
Drill Diameter			330 - 495 SFM		260 - 330 SFM		165 - 230 SFM		100 - 165 SFM		260 - 330 SFM	
Fractional	Metric mm	Decimal	RPM	Feed (IPR)	RPM	Feed (IPR)	RPM	Feed (IPR)	RPM	Feed (IPR)	RPM	Feed (IPR)
—	3	0.1181	16,000	0.004	11,000	0.004	7,400	0.004	5,300	0.004	11,000	0.002
5/32	3.969	0.1563	12,000	0.006	8,100	0.005	5,600	0.005	4,000	0.005	8,100	0.003
3/16	4.763	0.1875	10,000	0.007	6,800	0.006	4,700	0.007	3,400	0.006	6,800	0.004
—	5	0.1969	9,600	0.007	6,400	0.007	4,500	0.007	3,200	0.006	6,400	0.004
1/4	6.35	0.2500	7,500	0.009	5,100	0.008	3,500	0.009	2,500	0.007	5,100	0.005
—	8	0.3150	6,000	0.010	4,000	0.011	2,800	0.011	2,000	0.009	4,000	0.006
3/8	9.525	0.3750	5,000	0.012	3,400	0.013	2,400	0.012	1,700	0.010	3,400	0.007
—	10	0.3937	4,800	0.012	3,200	0.012	2,200	0.013	1,600	0.011	3,200	0.008
—	12	0.4724	4,000	0.015	2,700	0.015	1,900	0.015	1,300	0.012	2,700	0.009
1/2	12.7	0.5000	3,800	0.015	2,500	0.015	1,800	0.015	1,300	0.013	2,500	0.010
—	16	0.6299	3,000	0.017	2,000	0.018	1,400	0.018	1,000	0.015	2,000	0.012

Drilling in Dry Condition

Workpiece Material			Carbon Steels Cast Irons		Alloy Steels		Die Steels Hardened Steels (30-40HRc)		Hardened Steels (40-50HRc)		DuctileCast Irons	
Speed (SFM)			215 - 260 SFM		165 - 215 SFM		82 - 112 SFM		49 - 83 SFM		165 - 215 SFM	
Drill Diameter			215 - 260 SFM		165 - 215 SFM		82 - 112 SFM		49 - 83 SFM		165 - 215 SFM	
Fractional	Metric mm	Decimal	RPM	Feed (IPR)	RPM	Feed (IPR)	RPM	Feed (IPR)	RPM	Feed (IPR)	RPM	Feed (IPR)
—	3	0.1181	8,500	0.003	6,900	0.003	3,700	0.003	2,700	0.002	6,900	0.002
5/32	3.969	0.1563	6,400	0.004	5,200	0.004	2,700	0.004	2,000	0.003	5,200	0.003
3/16	4.763	0.1875	5,300	0.005	4,300	0.005	2,300	0.005	1,700	0.004	4,300	0.004
—	5	0.1969	5,100	0.005	4,100	0.005	2,200	0.005	1,600	0.004	4,100	0.004
1/4	6.35	0.2500	4,000	0.006	3,200	0.006	1,700	0.006	1,300	0.005	3,200	0.005
—	8	0.3150	3,200	0.008	2,600	0.008	1,400	0.008	1,000	0.006	2,600	0.006
3/8	9.525	0.3750	2,700	0.009	2,200	0.009	1,100	0.009	850	0.007	2,200	0.007
—	10	0.3937	2,500	0.009	2,100	0.009	1,100	0.009	800	0.007	2,100	0.007
—	12	0.4724	2,100	0.010	1,700	0.011	900	0.011	700	0.008	1,700	0.009
1/2	12.7	0.5000	2,000	0.011	1,600	0.011	850	0.011	630	0.008	1,600	0.010
—	16	0.6299	1,600	0.013	1,300	0.013	700	0.012	500	0.010	1,300	0.012

- 1) Drilling Aluminum Alloys, Light Metals, Stainless Steels are not recommended.
- 2) Use blow air for cooling and chip removal in dry processes.
- 3) Due to sparks during cutting, heat by breakage, or hot chips, there is danger of fire. Take fire prevention measures.
- 4) Adjust drilling condition when unusual vibration or different sound occurs.

Technical
Data

DRILLS

DRILLS
Cutting Condition

END MILLS

END MILLS
Cutting Condition

TAPS

TAPS
Cutting Condition

Others

AQUA Drills Regular List No. 9552

Hi-Speed Wet Drilling

Workpiece Material		Carbon Steels Cast Irons		Alloy Steels		Die Steels Hardened Steels (30-40HRc)		Hardened Steels (40-50HRc)		Ductile Cast Irons	
Speed (SFM)											
Drill Diameter		330 - 495 SFM		260 - 330 SFM		165 - 230 SFM		100 - 165 SFM		260 - 330 SFM	
Metric mm	Decimal	RPM	Feed (IPR)	RPM	Feed (IPR)	RPM	Feed (IPR)	RPM	Feed (IPR)	RPM	Feed (IPR)
3	0.1181	16,000	0.004	11,000	0.004	7,400	0.004	5,300	0.003	11,000	0.002
5	0.1969	9,600	0.006	6,400	0.006	4,500	0.006	3,200	0.005	6,400	0.004
8	0.3150	6,000	0.010	4,000	0.010	2,800	0.010	2,000	0.008	4,000	0.006
10	0.3937	4,800	0.011	3,200	0.011	2,200	0.011	1,600	0.010	3,200	0.007
12	0.4724	4,000	0.013	2,700	0.013	1,900	0.013	1,300	0.011	2,700	0.008
16	0.6299	3,000	0.016	2,000	0.016	1,400	0.016	1,000	0.013	2,000	0.011

Drilling in Dry Condition

Workpiece Material		Carbon Steels Cast Irons		Alloy Steels		Die Steels Hardened Steels (30-40HRc)		Hardened Steels (40-50HRc)		Ductile Cast Irons	
Speed (SFM)											
Drill Diameter		215 - 260 SFM		165 - 215 SFM		82 - 112 SFM		49 - 83 SFM		165 - 215 SFM	
Metric mm	Decimal	RPM	Feed (IPR)	RPM	Feed (IPR)	RPM	Feed (IPR)	RPM	Feed (IPR)	RPM	Feed (IPR)
3	0.1181	8,500	0.003	6,900	0.003	3,700	0.003	2,700	0.002	6,900	0.002
5	0.1969	5,100	0.004	4,100	0.005	2,200	0.004	1,600	0.004	4,100	0.004
8	0.3150	3,200	0.007	2,600	0.007	1,400	0.007	1,000	0.006	2,600	0.006
10	0.3937	2,500	0.008	2,100	0.008	1,100	0.009	800	0.007	2,100	0.007
12	0.4724	2,100	0.009	1,700	0.009	900	0.010	700	0.007	1,700	0.008
16	0.6299	1,600	0.011	1,300	0.012	700	0.011	500	0.009	1,300	0.011

- 1) Drilling Aluminum Alloys, Light Metals, Stainless Steels are not recommended.
- 2) Use blow air for cooling and chip removal in dry processes.
- 3) Due to sparks during cutting, heat by breakage, or hot chips, there is danger of fire. Take fire prevention measures.
- 4) Adjust drilling condition when unusual vibration or different sound occurs.

AQUA Drills 3 Flute List No. 9546

Drilling in Wet Condition

Workpiece Material		Carbon Steels Cast Irons		Alloy Steels		Die Steels Hardened Steels (30-40HRc)		Hardened Steels (40-50HRc)		Ductile Cast Irons	
Speed (SFM)											
Drill Diameter		215 - 260 SFM		160 - 195 SFM		130 - 165 SFM		98 - 130 SFM		132 - 163 SFM	
Metric mm	Decimal	RPM	Feed (IPR)	RPM	Feed (IPR)	RPM	Feed (IPR)	RPM	Feed (IPR)	RPM	Feed (IPR)
3	0.1181	8,500	0.004	6,400	0.004	5,300	0.003	4,200	0.002	5,300	0.002
5	0.1969	5,100	0.006	3,800	0.006	3,200	0.005	2,500	0.004	3,200	0.004
6	0.2362	4,200	0.008	3,200	0.007	2,700	0.006	2,100	0.005	2,700	0.005
8	0.3150	3,200	0.010	2,400	0.009	2,000	0.007	1,600	0.006	2,000	0.006
10	0.3937	2,500	0.011	1,900	0.011	1,600	0.009	1,300	0.007	1,600	0.007
12	0.4724	2,100	0.013	1,600	0.012	1,300	0.010	1,100	0.008	1,300	0.008
14	0.5512	1,820	0.014	1,360	0.014	1,140	0.011	910	0.009	1,140	0.009
16	0.6299	1,600	0.016	1,190	0.015	990	0.013	800	0.009	990	0.010

- 1) For precision drilling, use in wet condition.
- 2) In case of dry condition, reduce the rotation and feed to 70% of table values.
- 3) Use blow air for cooling and chip removal in dry processes.
- 4) Due to sparks during cutting, heat by breakage, or hot chips, there is danger of fire. Take fire prevention measures.
- 5) Adjust drilling condition when unusual vibration or different sound occurs.

AQUA Drills Hard List No. 9548

Workpiece Material		Work Hardness							
Speed (SFM)		50 - 55HRc		55 - 60HRc		60 - 65HRc		65HRc -	
Drill Diameter		98 - 130 SFM		65 - 82 SFM		49 - 66 SFM		33 - 50 SFM	
Metric mm	Decimal	RPM	Feed (IPR)	RPM	Feed (IPR)	RPM	Feed (IPR)	RPM	Feed (IPR)
2	0.0787	6,400	0.0020	4,000	0.0016	3,200	0.0012	2,400	0.0011
3	0.1181	4,200	0.0026	2,700	0.0020	2,100	0.0016	1,600	0.0015
4	0.1575	3,200	0.0032	2,000	0.0024	1,600	0.0016	1,200	0.0016
6	0.2362	2,100	0.0039	1,300	0.0030	1,100	0.0020	800	0.0016
8	0.3150	1,600	0.0047	1,000	0.0039	800	0.0020	600	0.0016
10	0.3937	1,300	0.0048	800	0.0047	640	0.0020	480	0.0016
12	0.4724	1,100	0.0047	660	0.0048	530	0.0020	400	0.0016

- 1) Recommend AQUA Drills Stub, AQUA Drills Regular in drilling work material when hardness is below 50HRc.
- 2) These table values are used in dry & wet conditions, but work material having over 60HRc hardness requires in wet condition.

AQUA Micro Drills List No. 9544

Drilling in Wet Condition

Workpiece Material		Carbon Steels Cast Irons			Alloy Steels			Die Steels Hardened Steels (30-40HRc)			Hardened Steels (40-50HRc)		
Drill Diameter		RPM	Feed (IPR)	Step Feed	RPM	Feed (IPR)	Step Feed	RPM	Feed (IPR)	Step Feed	RPM	Feed (IPR)	Step Feed
Metric mm	Decimal												
0.2	0.0079	31,800	0.0001	0.1D	26,500	0.0001	0.1D	21,200	0.0001	0.1D	12,700	0.0001	0.1D
0.3	0.0118	31,800	0.0001	0.1D	26,500	0.0001	0.1D	21,200	0.0001	0.1D	12,700	0.0001	0.1D
0.4	0.0157	31,800	0.0002	0.1D	25,900	0.0002	0.1D	19,900	0.0002	0.1D	12,700	0.0002	0.1D
0.5	0.0197	31,800	0.0002	0.1D	25,900	0.0002	0.1D	19,100	0.0002	0.1D	12,700	0.0002	0.1D
1.0	0.0394	23,900	0.0006	0.2D-0.5D ^{*)}	15,900	0.0006	0.2D-0.5D ^{*)}	12,700	0.0006	0.2D-0.5D ^{*)}	8,000	0.0005	0.1D
1.5	0.0591	21,200	0.0011	0.2D-0.5D ^{*)}	13,800	0.0011	0.2D-0.5D ^{*)}	9,500	0.0011	0.2D-0.5D ^{*)}	6,400	0.0009	0.1D
1.99	0.0783	19,200	0.0019	0.2D-0.5D ^{*)}	12,800	0.0020	0.2D-0.5D ^{*)}	8,000	0.0020	0.2D-0.5D ^{*)}	5,600	0.0015	0.1D

D: Drill Diameter

Workpiece Material		Hardened Steels (50-55HRc)			Ductile Cast Irons			Stainless Steels		
Drill Diameter		RPM	Feed (IPR)	Step Feed	RPM	Feed (IPR)	Step Feed	RPM	Feed (IPR)	Step Feed
Metric mm	Decimal									
0.2	0.0079	10,600	0.0001	0.1D	31,800	0.0001	0.1D	10,600	0.0001	0.1D
0.3	0.0118	10,600	0.0001	0.1D	31,800	0.0001	0.1D	10,600	0.0001	0.1D
0.4	0.0157	9,900	0.0002	0.1D	31,800	0.0002	0.1D	9,500	0.0002	0.1D
0.5	0.0197	9,500	0.0002	0.1D	31,800	0.0002	0.1D	9,500	0.0002	0.1D
1.0	0.0394	5,600	0.0004	0.1D	19,100	0.0006	0.2D-0.5D ^{*)}	5,600	0.0006	0.1D
1.5	0.0591	4,200	0.0006	0.1D	17,000	0.0011	0.2D-0.5D ^{*)}	4,200	0.0012	0.1D
1.99	0.0783	3,600	0.0008	0.1D	16,000	0.0014	0.2D-0.5D ^{*)}	3,600	0.0015	0.1D

D: Drill Diameter

- 1) These table values are for drilling with water soluble cutting fluid.
- 2) Drill diameters under 1mm must be used in wet condition.
- 3) Adjust drilling condition when unusual vibration or different sound occurs.
- 4) When using low speed machines, use the maximum speed and adjust the feed rate.
- 5) If drilling a deep hole over 3 times drill diameter, use pecking.

* SFM vary largely according the diameter. It is decided that AQUA Micro does not have SFM information.

Technical Data

DRILLS

DRILLS
Cutting Condition

END MILLS

END MILLS
Cutting Condition

TAPS

TAPS
Cutting Condition

Others

AQUA Drills with Mist Hole 3D List No. 9558

Hi-Speed Wet Drilling

Workpiece Material		Carbon Steels Cast Irons		Alloy Steels Pre-Hardened Steels		Mold Steels Hardened Steels (30-40HRc)		Hardened Steels (40-50HRc)		Ductile Cast Irons	
Speed (SFM)											
Drill Diameter		330 - 495 SFM		260 - 330 SFM		165 - 230 SFM		100 - 165 SFM		260 - 330 SFM	
Metric mm	Decimal	RPM	Feed (IPR)	RPM	Feed (IPR)	RPM	Feed (IPR)	RPM	Feed (IPR)	RPM	Feed (IPR)
5	0.1969	9,600	0.007	6,400	0.007	4,500	0.007	3,200	0.006	6,400	0.004
8	0.3150	6,000	0.010	4,000	0.011	2,800	0.011	2,000	0.009	4,000	0.006
10	0.3937	4,800	0.012	3,200	0.012	2,200	0.013	1,600	0.011	3,200	0.008
12	0.4724	4,000	0.015	2,700	0.015	1,900	0.015	1,300	0.012	2,700	0.009
16	0.6299	3,000	0.017	2,000	0.018	1,400	0.018	1,000	0.015	2,000	0.012

Drilling in Semi-Dry (Mist Coolant) Condition

Workpiece Material		Carbon Steels Cast Irons		Alloy Steels Pre-Hardened Steels		Mold Steels Hardened Steels (30-40HRc)		Hardened Steels (40-50HRc)		Ductile Cast Irons	
Speed (SFM)											
Drill Diameter		260 - 300 SFM		164 - 195 SFM		98 - 135 SFM		82 - 100 SFM		164 - 195 SFM	
Metric mm	Decimal	RPM	Feed (IPR)	RPM	Feed (IPR)	RPM	Feed (IPR)	RPM	Feed (IPR)	RPM	Feed (IPR)
5	0.1969	5,800	0.005	3,800	0.005	2,700	0.005	1,900	0.004	3,800	0.004
8	0.3150	3,600	0.008	2,400	0.008	1,700	0.008	1,200	0.007	2,400	0.006
10	0.3937	2,900	0.010	1,900	0.010	1,300	0.010	1,000	0.008	1,900	0.008
12	0.4724	2,400	0.011	1,600	0.011	1,100	0.012	800	0.009	1,600	0.009
16	0.6299	1,800	0.014	1,200	0.014	800	0.013	600	0.011	1,200	0.012

AQUA Drills with Mist Hole 5D List No. 9554

Hi-Speed Wet Drilling

Workpiece Material		Carbon Steels Cast Irons		Alloy Steels Pre-Hardened Steels		Mold Steels Hardened Steels (30-40HRc)		Hardened Steels (40-50HRc)		Ductile Cast Irons	
Speed (SFM)											
Drill Diameter		330 - 495 SFM		260 - 330 SFM		165 - 230 SFM		100 - 165 SFM		260 - 330 SFM	
Metric mm	Decimal	RPM	Feed (IPR)	RPM	Feed (IPR)	RPM	Feed (IPR)	RPM	Feed (IPR)	RPM	Feed (IPR)
5	0.1969	9,600	0.006	6,400	0.006	4,500	0.006	3,200	0.005	6,400	0.004
8	0.3150	6,000	0.010	4,000	0.010	2,800	0.010	2,000	0.008	4,000	0.006
10	0.3937	4,800	0.011	3,200	0.011	2,200	0.011	1,600	0.010	3,200	0.007
12	0.4724	4,000	0.013	2,700	0.013	1,900	0.013	1,300	0.011	2,700	0.008
16	0.6299	3,000	0.016	2,000	0.016	1,400	0.016	1,000	0.013	2,000	0.011

Drilling in Semi-Dry (Mist Coolant) Condition

Workpiece Material		Carbon Steels Cast Irons		Alloy Steels Pre-Hardened Steels		Mold Steels Hardened Steels (30-40HRc)		Hardened Steels (40-50HRc)		Ductile Cast Irons	
Speed (SFM)											
Drill Diameter		260 - 300 SFM		164 - 195 SFM		98 - 135 SFM		82 - 100 SFM		164 - 195 SFM	
Metric mm	Decimal	RPM	Feed (IPR)	RPM	Feed (IPR)	RPM	Feed (IPR)	RPM	Feed (IPR)	RPM	Feed (IPR)
5	0.1969	5,800	0.005	3,800	0.005	2,700	0.005	1,900	0.004	3,800	0.004
8	0.3150	3,600	0.007	2,400	0.008	1,700	0.007	1,200	0.006	2,400	0.006
10	0.3937	2,900	0.009	1,900	0.009	1,300	0.009	1,000	0.007	1,900	0.007
12	0.4724	2,400	0.010	1,600	0.010	1,100	0.011	800	0.008	1,600	0.008
16	0.6299	1,800	0.012	1,200	0.012	800	0.012	600	0.010	1,200	0.011

- 1) Drilling Aluminum Alloys and Light Metals are not recommended.
- 2) Use blow air for cooling and chip removal in dry processes.
- 3) Due to sparks during cutting, heat by breakage, or hot chips, there is danger of fire. Take fire prevention measures.
- 4) Adjust drilling condition when unusual vibration or different sound occurs.

Technical
Data

DRILLS

DRILLS
Cutting Condition

END MILLS

END MILLS
Cutting Condition

TAPS

TAPS
Cutting Condition

Others

AQUA Drills with Mist Hole 7D List No. 9556, 9569

Hi-Speed Wet Drilling

Workpiece Material			Carbon Steels Cast Irons		Alloy Steels		Die Steels Hardened Steels (30-40HRc)		Hardened Steels (40-50HRc)		Ductile Cast Irons	
Speed (SFM)												
Drill Diameter			330 - 495 SFM		260 - 330 SFM		165 - 230 SFM		100 - 165 SFM		260 - 330 SFM	
Fractional	Metric mm	Decimal	RPM	Feed (IPR)	RPM	Feed (IPR)	RPM	Feed (IPR)	RPM	Feed (IPR)	RPM	Feed (IPR)
3/16	4.763	0.1875	10,000	0.005	6,700	0.005	4,700	0.005	3,400	0.004	6,700	0.002
—	5	0.1969	9,600	0.005	6,400	0.005	4,500	0.005	3,200	0.004	6,400	0.003
1/4	6.35	0.2500	7,500	0.007	5,000	0.007	3,500	0.007	2,500	0.005	5,000	0.003
—	8	0.3150	6,000	0.008	4,000	0.008	2,800	0.008	2,000	0.006	4,000	0.004
3/8	9.525	0.3750	5,000	0.009	3,400	0.009	2,300	0.009	1,700	0.007	3,400	0.005
—	10	0.3937	4,800	0.009	3,200	0.009	2,200	0.009	1,600	0.008	3,200	0.005
—	12	0.4724	4,000	0.011	2,700	0.011	1,900	0.011	1,300	0.009	2,700	0.006
1/2	12.7	0.5000	3,800	0.011	2,500	0.011	1,800	0.011	1,250	0.009	2,500	0.006
—	16	0.6299	3,000	0.013	2,000	0.013	1,400	0.013	1,000	0.010	2,000	0.008

Drilling in Semi-Dry (Mist Coolant) Condition

Workpiece Material			Carbon Steels Cast Irons		Alloy Steels		Die Steels Hardened Steels (30-40HRc)		Hardened Steels (40-50HRc)		Ductile Cast Irons	
Speed (SFM)												
Drill Diameter			260 - 300 SFM		164 - 195 SFM		98 - 135 SFM		82 - 100 SFM		164 - 195 SFM	
Fractional	Metric mm	Decimal	RPM	Feed (IPR)	RPM	Feed (IPR)	RPM	Feed (IPR)	RPM	Feed (IPR)	RPM	Feed (IPR)
3/16	4.763	0.1875	6,100	0.004	4,000	0.004	2,800	0.004	2,000	0.003	4,000	0.002
—	5	0.1969	5,800	0.004	3,800	0.004	2,700	0.004	1,900	0.003	3,800	0.003
1/4	6.35	0.2500	4,500	0.005	3,000	0.005	2,100	0.005	1,500	0.004	3,000	0.003
—	8	0.3150	3,600	0.006	2,400	0.006	1,700	0.006	1,200	0.005	2,400	0.004
3/8	9.525	0.3750	3,000	0.007	2,000	0.007	1,400	0.007	1,000	0.005	2,000	0.005
—	10	0.3937	2,900	0.007	1,900	0.007	1,300	0.008	1,000	0.006	1,900	0.005
—	12	0.4724	2,400	0.008	1,600	0.008	1,100	0.008	800	0.006	1,600	0.006
1/2	12.7	0.5000	2,300	0.008	1,500	0.008	1,000	0.009	750	0.006	1,500	0.006
—	16	0.6299	1,800	0.009	1,200	0.009	800	0.009	600	0.007	1,200	0.008

- 1) Drilling Aluminum Alloys and Soft Metals are not recommended.
- 2) Use blow air for cooling and chip removal in dry processes.
- 3) Due to sparks during cutting, heat by breakage, or hot chips, there is danger of fire. Take fire prevention measures.
- 4) Adjust drilling condition when unusual vibration or different sound occurs.

DIAMOND Coated Carbide drills List No. 9501D

Work Material	Speed (SFM)	Feed Rate (IPR)
Aluminum Alloys	130 - 650	.002 - .008
Hi Si-Aluminum Alloys	130 - 300	.001 - .006
Copper Alloys	130 - 650	.002 - .008
Semi-Sinter Ceramics	60 - 250	.001 - .008
High Polymer Material	130 - 650	.001 - .006

- 1) Diamond Coated Drills are used in Nonferrous Metals such as Aluminum, Copper Alloys and FRP.
- 2) Adjust drilling condition when unusual vibration or different sound occurs.

Technical
Data

DRILLS

DRILLS
Cutting Condition

END MILLS

END MILLS
Cutting Condition

TAPS

TAPS
Cutting Condition

Others

Technical Data

DRILLS

DRILLS Cutting Condition

END MILLS

END MILLS Cutting Condition

TAPS

TAPS Cutting Condition

Others

VG OIL HOLE 3D L9588, L9589

Drilling in WET Conditions

Work Material			Cast Irons / Carbon Steels		Alloy Steels		Mold Steels / Hardened Steels (20-30 HRC)		Mold Steels / Hardened Steels (30-35 HRC)		Ductile Cast Irons		Stainless Steel (300-400 Series, 17-4PH, 15-5PH)		Nickel Alloys, Titanium Alloys		Aluminum Casting, Copper Alloys	
Speed (SFM)			RPM	Feed (IPR)	RPM	Feed (IPR)	RPM	Feed (IPR)	RPM	Feed (IPR)	RPM	Feed (IPR)	RPM	Feed (IPR)	RPM	Feed (IPR)	RPM	Feed (IPR)
Fractional	Metric mm	Decimal																
Drill Diameter (mm/inches)			260 - 270 SFM		190 - 200 SFM		160 - 185 SFM		130 - 160 SFM		200 - 225 SFM		130 - 170 SFM		65 - 110 SFM		260 - 400 SFM	
—	3	0.118	8500	0.004	6300	0.004	5300	0.003	4200	0.003	7000	0.004	4200	0.004	3200	0.001	9700	0.004
1/8	3.175	0.125	8000	0.004	6000	0.004	5100	0.003	4000	0.003	6500	0.004	4000	0.004	3100	0.001	9300	0.004
—	4	0.157	6400	0.005	4700	0.005	4000	0.003	3200	0.004	5100	0.005	3200	0.005	2400	0.002	7300	0.005
—	5	0.197	5100	0.006	3800	0.006	3200	0.004	2500	0.004	4100	0.006	2500	0.006	1900	0.002	5900	0.006
—	6	0.236	4300	0.007	3200	0.007	2700	0.005	2100	0.005	3500	0.007	2100	0.007	1700	0.002	4900	0.007
1/4	6.35	0.250	4000	0.008	3000	0.008	2500	0.005	2000	0.005	3200	0.007	2000	0.008	1600	0.002	4600	0.008
—	7	0.276	3650	0.009	2700	0.009	2300	0.005	1800	0.005	3000	0.008	1800	0.009	1350	0.003	4200	0.008
—	8	0.315	3200	0.010	2400	0.009	2000	0.006	1600	0.006	2600	0.009	1600	0.010	1200	0.003	3700	0.009
—	9	0.354	2800	0.011	2100	0.010	1800	0.007	1400	0.006	2300	0.010	1400	0.010	1100	0.003	3300	0.010
3/8	9.525	0.375	2700	0.012	2000	0.010	1700	0.007	1300	0.007	2200	0.010	1350	0.010	1000	0.004	3100	0.011
—	10	0.394	2500	0.012	1900	0.010	1600	0.008	1250	0.007	2100	0.010	1300	0.011	950	0.004	2900	0.011
—	11	0.433	2300	0.013	1700	0.010	1450	0.009	1100	0.008	1900	0.010	1150	0.011	850	0.004	2700	0.012
1/2	12.7	0.500	2000	0.013	1500	0.012	1250	0.010	1000	0.008	1650	0.012	1000	0.013	800	0.004	2300	0.014

VG OIL HOLE 5D L9586, L9587

Drilling in WET Conditions

Work Material			Cast Irons / Carbon Steels		Alloy Steels		Mold Steels / Hardened Steels (20-30 HRC)		Mold Steels / Hardened Steels (30-35 HRC)		Ductile Cast Irons		Stainless Steel (300-400 Series, 17-4PH, 15-5PH)		Nickel Alloys, Titanium Alloys		Aluminum Casting, Copper Alloys	
Speed (SFM)			RPM	Feed (IPR)	RPM	Feed (IPR)	RPM	Feed (IPR)	RPM	Feed (IPR)	RPM	Feed (IPR)	RPM	Feed (IPR)	RPM	Feed (IPR)	RPM	Feed (IPR)
Fractional	Metric mm	Decimal																
Drill Diameter (mm/inches)			260 - 270 SFM		190 - 200 SFM		160 - 185 SFM		130 - 160 SFM		200 - 225 SFM		130 - 170 SFM		65 - 110 SFM		260 - 400 SFM	
—	3	0.118	8500	0.004	6300	0.003	5300	0.002	4200	0.002	7000	0.004	4200	0.003	3200	0.001	9700	0.004
1/8	3.175	0.125	8000	0.004	6000	0.003	5100	0.002	4000	0.002	6500	0.004	4000	0.004	3100	0.001	9300	0.004
—	4	0.157	6400	0.005	4700	0.004	4000	0.003	3200	0.003	5100	0.005	3200	0.004	2400	0.002	7300	0.005
—	5	0.197	5100	0.006	3800	0.005	3200	0.004	2500	0.003	4100	0.006	2500	0.006	1900	0.002	5900	0.006
—	6	0.236	4300	0.007	3200	0.006	2700	0.004	2100	0.004	3500	0.007	2100	0.007	1700	0.002	4900	0.007
1/4	6.35	0.250	4000	0.008	3000	0.007	2500	0.005	2000	0.004	3200	0.007	2000	0.007	1600	0.002	4600	0.008
—	7	0.276	3650	0.009	2700	0.007	2300	0.005	1800	0.005	3000	0.008	1800	0.008	1350	0.003	4200	0.008
—	8	0.315	3200	0.010	2400	0.008	2000	0.006	1600	0.005	2600	0.009	1600	0.009	1200	0.003	3700	0.009
—	9	0.354	2800	0.011	2100	0.009	1800	0.007	1400	0.006	2300	0.010	1400	0.009	1100	0.003	3300	0.010
3/8	9.525	0.375	2700	0.012	2000	0.009	1700	0.007	1300	0.006	2200	0.010	1350	0.009	1000	0.004	3100	0.011
—	10	0.394	2500	0.012	1900	0.009	1600	0.007	1250	0.006	2100	0.010	1300	0.010	950	0.004	2900	0.011
—	11	0.433	2300	0.013	1700	0.009	1450	0.008	1100	0.007	1900	0.010	1150	0.010	850	0.004	2700	0.012
1/2	12.7	0.500	2000	0.013	1500	0.010	1250	0.009	1000	0.007	1650	0.012	1000	0.012	800	0.004	2300	0.014

- NOTE :** 1) Utilize the standard drilling condition shown in catalogs just as general guide, when starting operation.
 2) Adjust drilling conditions when unusual vibration or unusual sound occurs when cutting.
 3) When using low speed machines, use maximum speed and adjust the feed rate.

Formulas : $RPM = \frac{SFM \times 3.82}{\text{Drill dia.}}$ Feed Rate (in/min) : $RPM \times IPR$

MQL Power Long Drills List No. 9564, 9536

Drilling in MQL Conditions

Work Material		Cast Irons / Carbon Steels			Alloy Steels Pre-Hardened Steels		Mold Steels / Hardened Steels (-40HRc)		Ductile Cast Irons			
Drilling Condition		235 - 260 SFM			200 - 225 SFM		160 - 185 SFM		200 - 225 SFM			
10D 15D 20D	Drill Dia. (mm/ inches)	Fractional	Metric (mm)	Decimal	RPM	Feed (IPR)	RPM	Feed (IPR)	RPM	Feed (IPR)	RPM	Feed (IPR)
				3	0.118	0.125	7,600	0.004	6,400	0.003	5,100	0.003
	1/8	3.175	0.125	0.157	7,180	0.004	6,100	0.003	4,800	0.003	6,100	0.003
		4	0.157	0.197	5,700	0.005	4,850	0.004	3,850	0.004	4,850	0.004
		5	0.197	0.236	4,500	0.006	3,850	0.006	3,100	0.005	3,850	0.006
		6	0.236	0.276	3,800	0.007	3,200	0.007	2,600	0.006	3,200	0.007
	1/4	6.35	0.250	0.315	3,500	0.008	3,100	0.007	2,500	0.006	3,100	0.007
		7	0.276	0.354	3,250	0.008	2,750	0.008	2,200	0.007	2,800	0.008
		8	0.315	0.394	2,850	0.009	2,400	0.009	1,900	0.008	2,450	0.009
	11/32	8.731	0.344	0.433	2,600	0.009	2,200	0.009	1,750	0.009	2,250	0.010
		9	0.354	0.472	2,550	0.010	2,150	0.010	1,700	0.010	2,150	0.010
	3/8	9.525	0.375	0.512	2,400	0.010	2,000	0.010	1,650	0.010	2,000	0.011
		10	0.394	0.551	2,300	0.010	1,900	0.010	1,550	0.010	1,900	0.011
		11	0.433	0.591	2,100	0.011	1,750	0.011	1,400	0.011	1,800	0.012
		12	0.472	0.630	1,900	0.011	1,600	0.011	1,300	0.011	1,600	0.012
		13	0.512	0.669	1,750	0.012	1,500	0.012	1,200	0.012	1,500	0.012
		14	0.551	0.709	1,650	0.012	1,400	0.012	1,100	0.012	1,400	0.012
	9/16	14.28	0.562	0.709	1,600	0.012	1,350	0.012	1,100	0.012	1,400	0.012
		15	0.591	0.709	1,550	0.013	1,300	0.013	1,050	0.012	1,300	0.012
		16	0.630	0.709	1,450	0.013	1,200	0.013	1,000	0.012	1,200	0.013
		17	0.669	0.709	1,350	0.013	1,150	0.013	950	0.013	1,100	0.013
		18	0.709	0.709	1,250	0.013	1,050	0.013	900	0.013	1,050	0.013

Drilling in WET Conditions

Work Material		Cast Irons / Carbon Steels			Alloy Steels Pre-Hardened Steels		Mold Steels / Hardened Steels (-40HRc)		Ductile Cast Irons		Stainless Steel	
Drilling Condition		295-320 SFM			200-225 SFM		160-185 SFM		200-225 SFM		140 - 170 SFM	
10D 15D 20D	Drill Dia. (mm/ inches)	Fractional	Metric (mm)	Decimal	RPM	Feed (IPR)	RPM	Feed (IPR)	RPM	Feed (IPR)	RPM	Feed (IPR)
				3	0.118	0.125	9,500	0.0035	6,500	0.003	5,100	0.003
	1/8	3.175	0.125	0.157	9,000	0.004	6,100	0.003	4,900	0.003	6,100	0.003
		4	0.157	0.197	7,100	0.005	4,900	0.004	3,900	0.004	4,800	0.004
		5	0.197	0.236	5,700	0.006	3,900	0.006	3,100	0.005	3,900	0.006
		6	0.236	0.276	4,750	0.007	3,300	0.007	2,600	0.006	3,300	0.007
	1/4	6.35	0.250	0.315	4,500	0.008	3,100	0.007	2,500	0.006	3,100	0.008
		7	0.276	0.354	4,100	0.009	2,800	0.008	2,200	0.007	2,800	0.008
		8	0.315	0.394	3,600	0.010	2,500	0.009	2,000	0.008	2,500	0.009
	11/32	8.731	0.344	0.433	3,300	0.011	2,300	0.009	1,800	0.009	2,300	0.010
		9	0.354	0.472	3,200	0.011	2,200	0.010	1,700	0.009	2,200	0.010
	3/8	9.525	0.375	0.512	3,000	0.011	2,100	0.010	1,600	0.009	2,100	0.011
		10	0.394	0.551	2,900	0.012	2,000	0.010	1,500	0.010	2,000	0.011
		11	0.433	0.591	2,600	0.013	1,800	0.011	1,400	0.011	1,800	0.012
		12	0.472	0.630	2,400	0.014	1,600	0.011	1,300	0.011	1,600	0.013
		13	0.512	0.669	2,200	0.015	1,500	0.012	1,200	0.012	1,500	0.013
		14	0.551	0.709	2,100	0.014	1,400	0.012	1,100	0.012	1,400	0.013
	9/16	14.28	0.562	0.709	2,000	0.014	1,400	0.012	1,100	0.012	1,400	0.013
		15	0.591	0.709	1,900	0.013	1,300	0.013	1,050	0.013	1,300	0.013
		16	0.630	0.709	1,800	0.013	1,200	0.013	950	0.013	1,200	0.013
		17	0.669	0.709	1,700	0.014	1,150	0.014	900	0.014	1,150	0.014
		18	0.709	0.709	1,600	0.014	1,100	0.014	850	0.014	1,100	0.014

NOTE :

- 1) Guide(Pilot) hole is required. It is recommended to use same diameter or up to 0.1mm larger than diameter of the long drill. The depth of cut of the pilot hole should be 2xD in most cases or deeper.
- 2) We recommend using Nachi Guide(Pilot) Hole Drills with MQL Long Drills.
- 3) Utilize the standard drilling condition shown in catalogs just as general guide, when starting operation.
- 4) Adjust drilling conditions when unusual vibration or unusual sound occurs when cutting.
- 5) When using low speed machines, use maximum speed and adjust the feed rate.

Formulas :

RPM = SFM × 3.82
Drill dia.

Feed Rate (in/min) : RPM × IPR

Technical Data

DRILLS

DRILLS
Cutting Condition

END MILLS

END MILLS
Cutting Condition

TAPS

TAPS
Cutting Condition

Others

Technical Data

DRILLS

DRILLS Cutting Condition

END MILLS

END MILLS Cutting Condition

TAPS

TAPS Cutting Condition

Others

MQL Pilot Drills List No.9566

Drilling in MQL Conditions

Work Material			Cast Irons / Carbon Steels		Alloy Steels / Pre-Hardened Steels		Mold Steels / Hardened Steels (-40HRc)		Ductile Cast Irons		
Drilling Condition			235-260 SFM		200-225 SFM		160-185 SFM		200-225 SFM		
Drill Dia. (mm/inches)	Fractional	Metric (mm)	Decimal	RPM	Feed (IPR)	RPM	Feed (IPR)	RPM	Feed (IPR)	RPM	Feed (IPR)
		3	0.118	7,600	0.004	6,400	0.003	5,100	0.003	6,400	0.003
		4	0.157	5,700	0.005	4,800	0.004	3,800	0.004	4,800	0.004
		5	0.197	4,500	0.006	3,800	0.006	3,100	0.005	3,800	0.006
		6	0.236	3,800	0.008	3,200	0.007	2,500	0.006	3,200	0.007
		7	0.276	3,200	0.010	2,700	0.008	2,200	0.008	2,700	0.008
		8	0.315	2,800	0.011	2,400	0.009	1,900	0.009	2,400	0.009
		9	0.354	2,500	0.012	2,100	0.010	1,700	0.010	2,100	0.010
		10	0.394	2,200	0.013	1,900	0.010	1,500	0.010	1,900	0.011

Drilling in WET Conditions

Work Material			Cast Irons / Carbon Steels		Alloy Steels / Pre-Hardened Steels		Mold Steels / Hardened Steels (-40HRc)		Ductile Cast Irons		Stainless Steel		
Drilling Condition			295-320 SFM		200-225 SFM		160-185 SFM		200-225 SFM		140-170 SFM		
Drill Dia. (mm/inches)	Fractional	Metric (mm)	Decimal	RPM	Feed (IPR)	RPM	Feed (IPR)	RPM	Feed (IPR)	RPM	Feed (IPR)	RPM	Feed (IPR)
		3	0.118	9,500	0.004	6,400	0.003	5,100	0.003	6,450	0.003	5,170	0.003
		4	0.157	7,100	0.005	4,850	0.004	3,850	0.004	4,850	0.004	3,850	0.003
		5	0.197	5,700	0.007	3,880	0.006	3,100	0.005	3,850	0.006	3,100	0.005
		6	0.236	4,700	0.009	3,200	0.007	2,500	0.007	3,200	0.007	2,500	0.006
		7	0.276	4,000	0.010	2,750	0.008	2,200	0.008	2,750	0.008	2,200	0.007
		8	0.315	3,500	0.012	2,400	0.009	1,900	0.009	2,400	0.009	1,950	0.008
		9	0.354	3,100	0.012	2,150	0.010	1,700	0.010	2,150	0.010	1,700	0.008
		10	0.394	2,800	0.013	1,950	0.010	1,550	0.010	1,950	0.010	1,500	0.008

NOTE:

- 1) It is recommended that the pilot hole size be .05mm or .1mm bigger than the MQLPLD
- 2) Drill Depth for Pilot Holes: 2-3D or deeper
- 3) Utilize the standard drilling condition shown in catalogs just as general guide, when starting operation.
- 4) Adjust drilling conditions when unusual vibration or unusual sound occurs when cutting.
- 5) When using low speed machines, use maximum speed and adjust the feed rate.

Formulas:

$$RPM = \frac{SFM \times 3.82}{\text{Drill dia.}}$$

Feed Rate (in/min): RPM x IPR

DLC-HSS Drill List No. 544

Drilling in Wet Condition

Workpiece Material		Aluminum 1017		Aluminum Alloys						Aluminum Alloy Casting		Copper Alloys	
Speed (SFM)				4032, 6061		5052		7075					
Drill Diameter		330 - 390 SFM		210 - 260 SFM		280 - 330 SFM		210 - 260 SFM		210 - 260 SFM		150 - 200 SFM	
Metric mm	Decimal	RPM	Feed (IPR)	RPM	Feed (IPR)	RPM	Feed (IPR)	RPM	Feed (IPR)	RPM	Feed (IPR)	RPM	Feed (IPR)
1	0.0394	30,600	0.001	20,400	0.001	25,500	0.001	20,400	0.001	20,400	0.001	15,300	0.001
2	0.0787	19,100	0.002	12,700	0.002	15,900	0.002	12,700	0.002	12,700	0.002	9,600	0.002
3	0.1181	12,700	0.003	8,500	0.003	10,600	0.003	8,500	0.002	8,500	0.002	6,400	0.002
5	0.1969	7,600	0.005	5,100	0.005	6,400	0.005	5,100	0.004	5,100	0.004	3,800	0.004
8	0.3150	4,800	0.008	3,200	0.008	4,000	0.008	3,200	0.006	3,200	0.006	2,400	0.006
10	0.3937	3,800	0.010	2,500	0.010	3,200	0.010	2,500	0.008	2,500	0.008	1,900	0.008
12	0.4724	3,200	0.012	2,100	0.012	2,700	0.012	2,100	0.009	2,100	0.009	1,600	0.009
16	0.6299	2,400	0.013	1,600	0.013	2,000	0.013	1,600	0.010	1,600	0.010	1,200	0.010
20	0.7874	1,900	0.012	1,300	0.012	1,600	0.012	1,300	0.009	1,300	0.009	1,000	0.009

- 1) The table values are for drilling with water soluble cutting fluid.
- 2) DLC-HSS Drills are used in Nonferrous Metals such as Aluminum or Copper alloys.
- 3) Adjust drilling condition when unusual vibration or different sound occurs.
- 4) If drilling a deep hole over 3 times drill diameter, use pecking.

DLC Microdrills List No. 9524
DLC Drills Regular List No. 9520

Drilling in Wet & Semi Dry (Mist Coolant) Condition

Workpiece Material		Aluminum 1017		Aluminum Alloys						Aluminum Alloy Casting		Copper Alloys	
Speed (SFM)				4032, 6061		5052		7075					
Drill Diameter		650 - 820 SFM		330 - 500 SFM		500 - 650 SFM		500 - 650 SFM		430 - 590 SFM		260 - 330 SFM	
Metric mm	Decimal	RPM	Feed (IPR)	RPM	Feed (IPR)	RPM	Feed (IPR)	RPM	Feed (IPR)	RPM	Feed (IPR)	RPM	Feed (IPR)
0.5	0.0197	60,000	0.0002	58,000	0.0002	60,000	0.0002	60,000	0.0003	60,000	0.0003	38,000	0.0003
1	0.0394	50,000	0.0006	38,000	0.0006	50,000	0.0006	50,000	0.0007	48,000	0.0007	25,000	0.0007
2	0.0787	40,000	0.0014	24,000	0.0014	32,000	0.0015	32,000	0.0016	29,000	0.0016	16,000	0.0016
3	0.1181	26,500	0.0021	16,000	0.0021	21,000	0.0022	21,000	0.0024	19,000	0.0025	10,500	0.0024
5	0.1969	16,000	0.003	9,600	0.004	12,700	0.004	12,700	0.004	11,500	0.004	6,400	0.004
8	0.3150	10,000	0.006	6,000	0.006	8,000	0.006	8,000	0.006	7,200	0.007	4,000	0.006
10	0.3937	8,000	0.007	4,800	0.007	6,400	0.007	6,400	0.008	5,700	0.008	3,200	0.008
12	0.4724	6,600	0.008	4,000	0.008	5,300	0.009	5,300	0.010	4,800	0.010	2,650	0.010

Drilling in Dry Condition

Workpiece Material		Aluminum 1017		Aluminum Alloys						Aluminum Alloy Casting		Copper Alloys	
Speed (SFM)				4032, 6061		5052		7075					
Drill Diameter		-		210 - 260 SFM		280 - 330 SFM		330 - 390 SFM		280 - 330 SFM		164 - 196 SFM	
Metric mm	Decimal	RPM	Feed (IPR)	RPM	Feed (IPR)	RPM	Feed (IPR)	RPM	Feed (IPR)	RPM	Feed (IPR)	RPM	Feed (IPR)
0.5	0.0197	Not Used		30,000	0.0002	38,000	0.0002	45,000	0.0002	38,000	0.0002	22,000	0.0002
1	0.0394		20,000	0.0004	25,000	0.0004	30,000	0.0005	25,000	0.0005	15,000	0.0005	
2	0.0787		12,500	0.0010	16,000	0.0010	19,000	0.0012	16,000	0.0012	9,500	0.0012	
3	0.1181		8,500	0.0015	10,600	0.0016	12,700	0.0018	10,600	0.0018	6,400	0.0017	
5	0.1969		5,100	0.0025	6,400	0.0026	7,600	0.003	6,400	0.003	3,800	0.003	
8	0.3150		3,200	0.004	4,000	0.004	4,800	0.005	4,000	0.005	2,400	0.005	
10	0.3937		2,550	0.005	3,200	0.005	3,800	0.006	3,200	0.006	1,900	0.006	
12	0.4724		2,100	0.006	2,650	0.006	3,200	0.007	2,650	0.007	1,600	0.007	

- 1) DLC Drills are used in Nonferrous Metals such as Aluminum or Copper Alloys.
- 2) Adjust drilling condition when unusual vibration or different sound occurs.
- 3) When using low speed machines, use the maximum speed and adjust the feed rate.

Technical Data

DRILLS

DRILLS Cutting Condition

END MILLS

END MILLS Cutting Condition

TAPS

TAPS Cutting Condition

Others

STANDARD DRILLING CONDITION

Technical Data

Straight Shank Drills

**Jobbers Length
Screw Machine Length
Taper Length**

**List No. 500, 501, 501A, 599
List No. 561, 563
List No. 531**

Straight Shank Cobalt Drills

**Jobbers Length
Screw Machine Length
Taper Length**

**List No. 6501, 6520, 599
List No. 6563
List No. 6531**

DRILLS

Workpiece Material			Carbon Steels		Alloy Steels Hardened Steels		Mold Steels Stainless Steels		Titanium Alloys ¹⁾ High Temperature Alloys ¹⁾		Cast Irons		Aluminum Alloys Nonferrous Metals	
Speed (SFM)			50 - 65 SFM		40 - 52 SFM		30 - 40 SFM		10 - 20 SFM		55 - 72 SFM		83 - 115 SFM	
Drill Diameter			50 - 65 SFM		40 - 52 SFM		30 - 40 SFM		10 - 20 SFM		55 - 72 SFM		83 - 115 SFM	
Fractional	Metric mm	Decimal	RPM	Feed (IPR)	RPM	Feed (IPR)	RPM	Feed (IPR)	RPM	Feed (IPR)	RPM	Feed (IPR)	RPM	Feed (IPR)
—	1	0.0394	4,800	0.0008	3,800	0.0007	2,900	0.0006	1,500	0.0003	5,300	0.0010	8,100	0.0007
1/16	1.588	0.0625	3,400	0.0013	2,700	0.0011	2,100	0.0009	1,000	0.0005	3,800	0.0015	5,800	0.0011
—	2	0.0787	2,900	0.0016	2,300	0.0013	1,700	0.0012	720	0.0006	3,200	0.0020	4,900	0.0014
—	3	0.1181	2,100	0.0028	1,700	0.0023	1,300	0.0021	480	0.0009	2,300	0.0034	3,600	0.0024
1/8	3.175	0.1250	2,000	0.0029	1,700	0.0023	1,200	0.0022	460	0.0010	2,200	0.0036	3,500	0.0025
—	5	0.1969	1,300	0.0042	1,000	0.0037	760	0.0033	290	0.0015	1,400	0.0053	2,200	0.0038
1/4	6.35	0.2500	1,100	0.0047	800	0.0044	610	0.0038	230	0.0020	1,120	0.0064	1,750	0.0044
—	8	0.3150	800	0.0059	640	0.0050	480	0.0044	180	0.0025	900	0.0074	1,400	0.0051
3/8	9.525	0.3750	680	0.0065	540	0.0055	400	0.0049	160	0.0030	740	0.0082	1,200	0.0054
—	10	0.3937	640	0.0068	510	0.0057	380	0.0050	150	0.0032	700	0.0084	1,100	0.0057
—	12	0.4724	530	0.0074	420	0.0064	320	0.0057	120	0.0040	580	0.0095	900	0.0066
1/2	12.7	0.5000	510	0.0076	400	0.0066	310	0.0057	120	0.0043	550	0.0099	860	0.0069
5/8	15.875	0.6250	410	0.0089	330	0.0076	250	0.0065	100	0.0050	450	0.0115	690	0.0086
—	16	0.6299	400	0.0091	320	0.0078	240	0.0067	90	0.0050	440	0.0116	680	0.0087

- 1) The cutting condition of Titanium Alloys and Nickel Alloys are for HSS-Co drills only.
- 2) The above values apply when coolant is used in a vertical machine. In a horizontal machine or deep hole, use pecking.
- 3) Adjust drilling condition when unusual vibration or different sound occurs.

DRILLS
Cutting Condition

END MILLS

END MILLS
Cutting Condition

**Straight Shank Drills TiN Coated Jobbers Length List No. 501P, 520P
Screw Machine Length List No. 561P**

Workpiece Material			Carbon Steels		Alloy Steels		Die Steels Hardened Steels Stainless Steels		Cast Irons		Aluminum Alloys Nonferrous Metals	
Speed (SFM)			60 - 85 SFM		47 - 65 SFM		36 - 48 SFM		66 - 90 SFM		100 - 140 SFM	
Drill Diameter			60 - 85 SFM		47 - 65 SFM		36 - 48 SFM		66 - 90 SFM		100 - 140 SFM	
Fractional	Metric mm	Decimal	RPM	Feed (IPR)	RPM	Feed (IPR)	RPM	Feed (IPR)	RPM	Feed (IPR)	RPM	Feed (IPR)
—	1	0.0394	5,800	0.0008	4,600	0.0007	3,500	0.0006	6,400	0.0010	9,800	0.0007
1/16	1.588	0.0625	4,100	0.0013	3,200	0.0011	2,500	0.0009	4,400	0.0015	7,000	0.0011
—	2	0.0787	3,500	0.0016	2,800	0.0013	2,000	0.0012	3,800	0.0020	5,900	0.0014
—	3	0.1181	2,500	0.0028	2,000	0.0023	1,500	0.0021	2,800	0.0034	4,300	0.0024
1/8	3.175	0.1250	2,400	0.0029	2,000	0.0023	1,400	0.0022	2,600	0.0036	4,200	0.0025
—	5	0.1969	1,600	0.0042	1,200	0.0037	910	0.0033	1,700	0.0053	2,600	0.0038
1/4	6.35	0.2500	1,300	0.0047	1,000	0.0044	730	0.0038	1,300	0.0064	2,100	0.0044
—	8	0.3150	1,000	0.0059	770	0.0050	580	0.0044	1,100	0.0074	1,700	0.0051
3/8	9.525	0.3750	820	0.0065	650	0.0055	480	0.0049	890	0.0082	1,400	0.0054
—	10	0.3937	770	0.0068	610	0.0057	460	0.0050	840	0.0084	1,300	0.0057
—	12	0.4724	640	0.0074	500	0.0064	380	0.0057	700	0.0095	1,100	0.0066
1/2	12.7	0.5000	610	0.0076	490	0.0066	370	0.0057	670	0.0099	1,000	0.0069
5/8	15.875	0.6250	500	0.0089	400	0.0076	300	0.0065	540	0.0115	830	0.0086
—	16	0.6299	480	0.0091	380	0.0078	290	0.0067	530	0.0116	820	0.0087

- 1) The above values apply when coolant is used in a vertical machine. In a horizontal machine or deep hole, use pecking.
- 2) Adjust drilling condition when unusual vibration or different sound occurs.

TAPS
Cutting Condition

Others

**Straight Shank Drills Parabolic Style TiN Coated Jobbers Length List No. 517P
Taper Length List No. 545P**

Workpiece Material			Carbon Steels		Alloy Steels		Die Steels Hardened Steels Stainless Steels		Cast Irons	
Speed (SFM)			60 - 85 SFM		47 - 65 SFM		36 - 48 SFM		66 - 90 SFM	
Drill Diameter			60 - 85 SFM		47 - 65 SFM		36 - 48 SFM		66 - 90 SFM	
Fractional	Metric mm	Decimal	RPM	Feed (IPR)	RPM	Feed (IPR)	RPM	Feed (IPR)	RPM	Feed (IPR)
—	1	0.0394	5,800	0.0011	4,600	0.0009	3,500	0.0008	6,400	0.0014
1/16	1.588	0.0625	4,100	0.0018	3,200	0.0014	2,500	0.0012	4,400	0.0021
—	2	0.0787	3,500	0.0023	2,800	0.0017	2,000	0.0015	3,800	0.0028
—	3	0.1181	2,500	0.0039	2,000	0.0030	1,500	0.0027	2,800	0.0048
1/8	3.175	0.1250	2,400	0.0041	2,000	0.0030	1,400	0.0029	2,600	0.0050
—	5	0.1969	1,600	0.0059	1,200	0.0048	910	0.0042	1,700	0.0075
1/4	6.35	0.2500	1,300	0.0066	1,000	0.0057	730	0.0049	1,300	0.0089
—	8	0.3150	1,000	0.0083	770	0.0066	580	0.0058	1,100	0.0104
3/8	9.525	0.3750	820	0.0091	650	0.0072	480	0.0063	890	0.0115
—	10	0.3937	770	0.0095	610	0.0074	460	0.0065	840	0.0118
—	12	0.4724	640	0.0104	500	0.0083	380	0.0074	700	0.0133
1/2	12.7	0.5000	610	0.0107	490	0.0086	370	0.0075	670	0.0139
5/8	15.875	0.6250	500	0.0124	400	0.0099	300	0.0085	540	0.0161
—	16	0.6299	480	0.0127	380	0.0101	290	0.0087	530	0.0163

1) The above values apply when coolant is used in a vertical machine. In a horizontal machine or deep hole, use pecking.
2) Adjust drilling condition when unusual vibration or different sound occurs.

**Straight Shank Drills Extra Length List No. 551, 6551
Taper Shank Drills Extra Length List No. 651**

Workpiece Material		Carbon Steels		Alloy Steels Hardened Steels		Stainless Steels		Cast Irons		Brass Nonferrous Metals	
Speed (SFM)		44 - 55 SFM		32 - 40 SFM		32 - 40 SFM		52 - 65 SFM		48 - 60 SFM	
Drill Diameter		44 - 55 SFM		32 - 40 SFM		32 - 40 SFM		52 - 65 SFM		48 - 60 SFM	
Fractional	Decimal	RPM	Feed (IPR)	RPM	Feed (IPR)	RPM	Feed (IPR)	RPM	Feed (IPR)	RPM	Feed (IPR)
1/16	0.0625	2,700	0.0020	2,000	0.0010	2,000	0.0015	3,200	0.0015	3,000	0.0020
1/8	0.1250	1,600	0.0038	1,200	0.0018	1,200	0.0025	1,800	0.0025	1,700	0.0036
3/16	0.1875	1,200	0.0052	820	0.0025	820	0.0035	1,400	0.0035	1,300	0.0050
1/4	0.2500	850	0.0065	620	0.0030	620	0.0048	1,000	0.0048	1,000	0.0063
5/16	0.3125	680	0.0075	490	0.0035	490	0.0055	800	0.0055	740	0.0078
3/8	0.3750	570	0.0090	410	0.0040	410	0.0060	670	0.0060	620	0.0090
1/2	0.5000	430	0.0110	310	0.0052	310	0.0080	500	0.0080	460	0.0110
5/8	0.6250	340	0.0120	250	0.0060	250	0.0090	400	0.0090	370	0.0120
3/4	0.7500	290	0.0130	210	0.0070	210	0.0100	340	0.0100	310	0.0130
1	1.0000	220	0.0140	160	0.0080	160	0.0110	250	0.0110	230	0.0140

1) The above values apply when coolant is used in a vertical machine. In a horizontal machine or deep hole, use pecking.
2) Adjust drilling condition when unusual vibration or different sound occurs.

Technical Data

DRILLS

DRILLS
Cutting Condition

END MILLS

END MILLS
Cutting Condition

TAPS

TAPS
Cutting Condition

Others

Straight Shank Oil Hole Drills / Cobalt List No. 581

Workpiece Material		Carbon Steels		Alloy Steels		Die Steels Hardened Steels Stainless Steels		Cast Irons		Aluminum Alloys Nonferrous Metals	
Speed (SFM)		55 - 66 SFM		44 - 52 SFM		32 - 40 SFM		61 - 73 SFM		94 - 114 SFM	
Drill Diameter		55 - 66 SFM		44 - 52 SFM		32 - 40 SFM		61 - 73 SFM		94 - 114 SFM	
Fractional	Decimal	RPM	Feed (IPR)	RPM	Feed (IPR)	RPM	Feed (IPR)	RPM	Feed (IPR)	RPM	Feed (IPR)
1/16	0.0625	3,400	0.0016	2,700	0.0013	2,100	0.0011	3,800	0.0018	5,800	0.0013
1/8	0.1250	2,000	0.0035	1,700	0.0027	1,200	0.0027	2,200	0.0043	3,500	0.0030
1/4	0.2500	1,100	0.0056	800	0.0052	610	0.0046	1,120	0.0076	1,750	0.0053
3/8	0.3750	680	0.0078	540	0.0066	400	0.0058	740	0.0099	1,200	0.0065
1/2	0.5000	510	0.0091	400	0.0079	310	0.0069	550	0.0119	860	0.0082
5/8	0.6250	410	0.0106	330	0.0091	250	0.0079	450	0.0138	690	0.0103

- 1) The above values apply when coolant is used in a vertical machine. In a horizontal machine or deep hole, use pecking.
- 2) Adjust drilling condition when unusual vibration or different sound occurs.

Technical Data

DRILLS

DRILLS
Cutting Condition

END MILLS

END MILLS
Cutting Condition

TAPS

TAPS
Cutting Condition

Others

**Taper Shank Drills Regular Shank / Core Drills List No. 601
Silver and Deming Drills List No. 575**

Workpiece Material		Carbon Steels		Alloy Steels		Die Steels Hardened Steels Stainless Steels		Cast Irons		Aluminum Alloys Nonferrous Metals	
Speed (SFM)		55 - 65 SFM		50 - 60 SFM		35 - 45 SFM		65 - 80 SFM		100 - 110 SFM	
Drill Diameter		55 - 65 SFM		50 - 60 SFM		35 - 45 SFM		65 - 80 SFM		100 - 110 SFM	
Fractional	Decimal	RPM	Feed (IPR)	RPM	Feed (IPR)	RPM	Feed (IPR)	RPM	Feed (IPR)	RPM	Feed (IPR)
1/8	0.1250	2,000	0.003	1,900	0.003	1,400	0.002	2,500	0.004	3,400	0.003
3/16	0.1875	1,400	0.004	1,300	0.004	920	0.003	1,700	0.005	2,300	0.005
1/4	0.2500	1,000	0.004	920	0.005	690	0.004	1,300	0.007	1,700	0.006
5/16	0.3125	800	0.004	740	0.005	560	0.005	980	0.008	1,400	0.008
3/8	0.3750	670	0.007	620	0.006	460	0.005	820	0.008	1,200	0.008
7/16	0.4375	570	0.007	530	0.006	400	0.005	700	0.009	970	0.009
1/2	0.5000	500	0.008	460	0.006	350	0.006	620	0.010	850	0.009
5/8	0.6250	400	0.009	370	0.008	280	0.007	490	0.012	680	0.012
3/4	0.7500	340	0.010	310	0.009	230	0.008	410	0.013	570	0.013
7/8	0.8750	290	0.011	270	0.009	200	0.008	350	0.014	490	0.014
1	1.0000	250	0.012	230	0.010	180	0.009	310	0.015	430	0.014
1 1/8	1.1250	230	0.012	210	0.011	160	0.010	280	0.016	380	0.015
1 1/4	1.2500	200	0.014	190	0.011	140	0.010	250	0.016	340	0.016
1 3/8	1.3750	190	0.014	170	0.012	130	0.010	230	0.017	310	0.017
1 1/2	1.5000	170	0.014	160	0.012	120	0.011	210	0.017	290	0.017
1 5/8	1.6250	160	0.015	150	0.013	110	0.011	190	0.017	260	0.017
1 3/4	1.7500	150	0.016	140	0.013	100	0.011	180	0.018	250	0.018
1 7/8	1.8750	140	0.016	130	0.014	100	0.012	170	0.019	230	0.019
2	2.0000	130	0.016	120	0.014	90	0.012	160	0.020	220	0.020

Taper Shank Oil Hole Drills / Cobalt List No. 683

Workpiece Material		Carbon Steels		Alloy Steels Hardened Steels		Mold Steels Stainless Steels		Cast Irons		Aluminum Alloys Nonferrous Metals	
Speed (SFM)		55 - 65 SFM		50 - 60 SFM		35 - 45 SFM		65 - 80 SFM		100 - 110 SFM	
Drill Diameter		55 - 65 SFM		50 - 60 SFM		35 - 45 SFM		65 - 80 SFM		100 - 110 SFM	
Fractional	Decimal	RPM	Feed (IPR)	RPM	Feed (IPR)	RPM	Feed (IPR)	RPM	Feed (IPR)	RPM	Feed (IPR)
3/8	0.3750	680	0.008	620	0.007	460	0.006	820	0.010	1,200	0.010
7/16	0.4375	580	0.009	530	0.007	400	0.006	700	0.011	970	0.011
1/2	0.5000	510	0.009	460	0.008	350	0.007	620	0.012	850	0.012
5/8	0.6250	410	0.011	370	0.010	280	0.008	490	0.014	680	0.014
23/32	0.7188	360	0.012	320	0.010	240	0.009	430	0.015	590	0.014
3/4	0.7500	340	0.013	310	0.011	230	0.009	410	0.015	570	0.015
7/8	0.8750	290	0.013	270	0.011	200	0.010	350	0.017	490	0.017
1	1.0000	260	0.014	230	0.012	180	0.011	310	0.018	430	0.018
1 1/4	1.2500	210	0.016	190	0.013	140	0.011	250	0.019	340	0.019
1 1/2	1.5000	170	0.017	160	0.014	120	0.012	210	0.021	290	0.021

1) The above values apply when coolant is used in a vertical machine. In a horizontal machine or deep hole, use pecking.
2) Adjust drilling condition when unusual vibration or different sound occurs.

Technical
Data

DRILLS

DRILLS
Cutting Condition

END MILLS

END MILLS
Cutting Condition

TAPS

TAPS
Cutting Condition

Others

Technical Data

DRILLS

DRILLS Cutting Condition

END MILLS

END MILLS Cutting Condition

TAPS

TAPS Cutting Condition

Others

TERMS FOR DRILLS

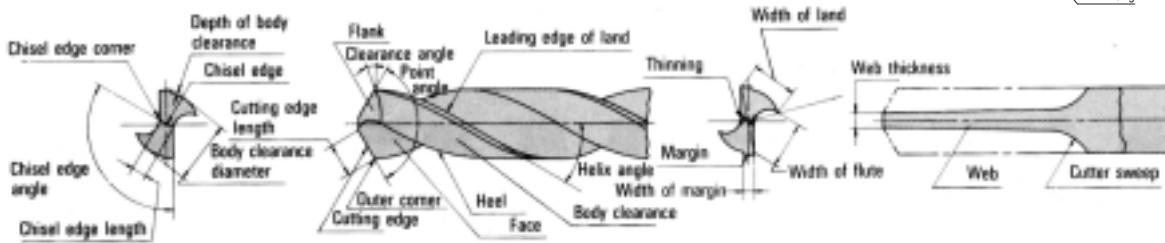
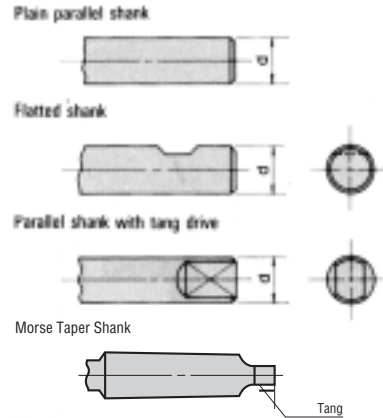
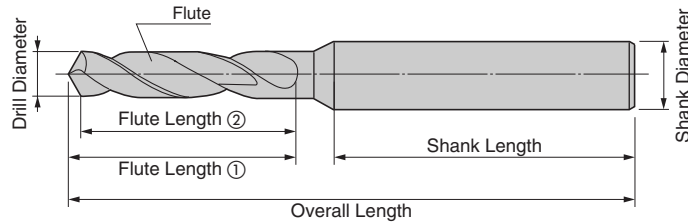

Precautions in using drills: 6-point

1. PROPER SELECTION OF DRILLS

Depending on work material and cutting conditions, standard drills can be used for drilling holes in materials. However, to ensure efficient and economical production, it is important that the proper drill is selected for each drilling operation.

3. CORRECT HOLDING OF DRILLS

Of the time spent in drilling operations, net cutting time is surprisingly short and setting up time is much longer.

Consequently, improved efficiency in attaching and detaching of drill from its holder is decidedly important from the point of view of increased productivity.

5. PROPER CUTTING SPEED AND FEED RATE

Incorrect cutting speed and feed may cause the drill to wear excessively or even to break and will greatly shorten drill life. Cutting conditions are determined by the shape and machining qualities of the material, condition of the drilling machine, jigs and so forth, select proper values, referring to the cutting conditions. When deep hole drilling, reduce the cutting speed and feed in accordance with table shown in below.

Speed and feed reductions for drilling deep holes

HOLE DEPTH	CUTTING SPEED REDUCTION RATE	FEED REDUCTION RATE
3 Times Diameter	10%	10%
4 Times Diameter	20%	10%
5 Times Diameter	30%	20%
6-8 Times Diameter	35-40%	20%

2. MAINTENANCE OF DRILLING MACHINE, JIGS AND FIXTURES

For prolonging the drill life and maintaining accurate hole production, both the drilling machine used and jigs and fixtures must preserve high rigidity.

4. CORRECT CLAMPING OF WORKPIECE

6. REGRINDING

When a drill is used until it is completely worn and does not cut, disadvantages will accumulate such as decreased production, deterioration of surface finish, reduced accuracy, drill breakage, increased amount of stock removal in regrinding and so forth. It is much better to sharpen a drill before it is worn completely. When correcting regrinding, the following five points should be carefully observed:

- Completely remove the worn part (rough grind).
- Center the chisel point.
- The lengths of each cutting edge must be equal.
- Regardless of the point angle, each cutting edge must be equally inclined to the axis of the drill.
- Make the clearance angles proper and each clearance angle identical.

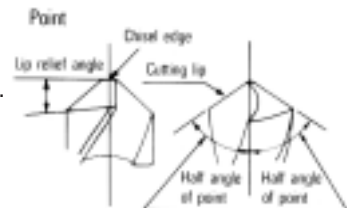

THE MAIN GEOMETRY FACTOR OF DRILLS AND THEIR WORK

CHARACTERISTICS	Cutting Resistance		Rigidity		Chip Removable	Guide Prfrmnc.	Amount of burr at the end	Remark
	Thrust	Torque	Body	Cutting Edge				
Helix Angle	High ↑ ↓ Low	Small ↑ ↓ Big	Small ↑ ↓ Big	Small ↑ ↓ Big	Good ↑ ↓ Big	Good ↑ ↓ Bad	Small ↑ ↓ Big	When the helix angle is getting bigger, the cutting resistance is decreased, but the drill's rigidity down. High helix angle is adopted for soft material, and low helix angle is adopted, for brittle material.
Point Angle	Big ↑ ↓ Small	Big ↑ ↓ Small	Small ↑ ↓ Big				Small ↑ ↓ Big	When the point angle is getting small, thrust is also small, but torque the gets bigger. For general purpose, 118 point angle is adopted. For hard material, or for high-speed cutting, 135 is recommended.
Web Thickness	Big ↑ ↓ Small	Big ↑ ↓ Small	Big ↑ ↓ Small	Big ↑ ↓ Small		Bad ↑ ↓ Good		To increase the drill web thickness, the rigidity of drill should be bigger. But thrust is also increased because of long chisel edge. To decrease thrust, the thinning is treated.
Clearance Angle	Big ↑ ↓ Small	Small ↑ ↓ Big			Small ↑ ↓ Big		Small ↑ ↓ Big	If large clearance angle is taken, thrust is decreased, and flank wear is also decreased, but cutting edge is getting brittle. For hard material, small clearance angle is taken, for soft material, large clearance angle is taken.
Back Taper	Big ↑ ↓ Small		Small ↑ ↓ Big				Bad ↑ ↓ Good	When back taper is getting bigger, torque is smaller, and worn margin length is also smaller. But too much back taper has less guide performance, and straightness of hole is decreased

Technical Data

DRILLS

DRILLS Cutting Condition

END MILLS

END MILLS Cutting Condition









TAPS

TAPS Cutting Condition

Others









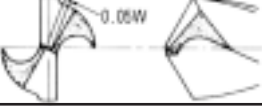

Shape of lip relief

The conical grinding method is broadly adopted as the most normal one. The other lip relieves are chosen according to the application when it is preferable to make the highly accurate holes.

Shape	Features · Effects	Application	Symbol
Conical 	<ul style="list-style-type: none"> ● the most normal grinding method ● The lip relief angle becomes greater as to it approaches to the center from corner because of grinding the lip relief conically. 	General purpose	
Flat 	<ul style="list-style-type: none"> ● grind the lip relief planely ● easy grinding 	small diameter	
Three-rake 	<ul style="list-style-type: none"> ● having good centripetalability because of no chisel edge ● less enlargement of hole ● need special grinder 	drilling high accurate hole and location	
Spiral point 	<ul style="list-style-type: none"> ● lip relief spirally ground makes an S-shaped chisel edge ● brings good centripetalability and high accuracy 	drilling high accurate hole	
Radial-lip 	<ul style="list-style-type: none"> ● making load uniformly disperse on curved-edge depending on grinding cutting edges to curved-one ● get good accuracy and surface roughness by this point ● less burr on exit side of through hole ● need special grinder 	cast iron, light alloy and steel plate	
Fishtail 	<ul style="list-style-type: none"> ● bring good centripetalability and less shock when penetrate ● less burr when penetrate 	thin plate	

Web Thinning



The proportion of drill resistance caused by the various drilling force concentrates on the chisel edge. The thrust force on chisel edge is in the same proportions as that on the lip. Drill-thrust force is very sensitive to variations of chisel-edge length or web thickness. Web thinning reduces drilling thrust and produces other advantages such as reduced cutting temperature, increased drill life and improved hole geometry. In order to recondition the drill properly, it is necessary to reduce this web thickness.

Type	Features · Effects	Application	Symbol
S-type 	<ul style="list-style-type: none"> ● very easy to make thinning 	General purpose for steel, cast iron, non-ferrous metal	
X-type (split point) 	<ul style="list-style-type: none"> ● reduce thrust force substantially ● advantage when entering ● This type of thinning is very effective for thick web 	<ul style="list-style-type: none"> ● drilling deep hole ex. oil-hole of crankshaft ● material of low-machinability and of machining hardenability 	 
N-type 	<ul style="list-style-type: none"> ● effective for thick web 	<ul style="list-style-type: none"> ● drilling deep hole 	
R-type 	<ul style="list-style-type: none"> ● reduce thrust force substantially ● lessen chipping on cutting edges 	<ul style="list-style-type: none"> ● heavy duty ● rail or manganese steel 	
XS-type 	<ul style="list-style-type: none"> ● easier grinding than x-type ● reduce thrust force substantially ● advantage when entering 	<ul style="list-style-type: none"> ● drilling deep hole 	
H-type 	<ul style="list-style-type: none"> ● lessen web thickness and strengthen chisel at same time 	<ul style="list-style-type: none"> ● heavy duty 	

Figures reference only

Chip Breaker

Since continuous chips do not discharge easily, it is necessary to break these forcibly. Particularly, to change the shape of continuous chips generated in the deep hole processing of tough materials, it is desirable that the drill shall be provided with a chipbreaker. Examples of chipbreakers are shown below.

Type	Effect
	The rake angle is decreased by grinding the face flat along the cutting edge, preventing the winding of chips on the drill. In this case, the breaker must not affect the margin.
	The face is ground in the same way as for a chip breaker for a bit. This form of grinding is very difficult and, since there is a danger of breaking the margin, the amount of the breaker must be kept at minimum, care must be exercised to prevent interference with the chip pocket. This chipbreaker effective especially in the processing of deep holes.
	This nicks on the flank function as chip breakers. Stagger the positions of nicks so that distances of the nicks from the drill axis are not identical. Cut chips become thin and long and they discharged smoothly.

ex. Characteristics of the drills for deep hole

To drill a very deep hole, it is necessary for the drills to have the following four features:

1. Good removal of the cutting chip
2. Good penetration of the cutting coolant
3. Good heat resistance
4. High rigidity

We show the geometries for the drills as shown in the illustration.

The drill has a thick web for strength and proper thinning for less thrust force.

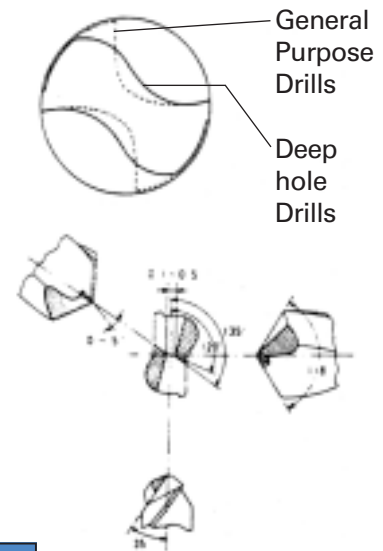

Drilling Terminology

Terms	Descriptions	Formulas
IPM	Inches Per Minutes	IPR x RPM
IPR	Inches Per Revolution	$\frac{IPM}{RPM}$
RPM	Revolutions Per Minute	$\frac{SFM \times 3.82}{D}$
SFM	Surface Feet Per Minute	D x RPM x 0.26
D	Drill Diameter	

Technical Data

DRILLS

DRILLS Cutting Condition

END MILLS

END MILLS Cutting Condition

TAPS

TAPS Cutting Condition

Others

OPERATING INSTRUCTIONS FOR RE-SHARPENING OF SG-ES & SG-ESS DRILLS

Accurate re-sharpening is one of the most important skills that a qualified worker must have.

SG-ESS RE-SHARPENING

1. DIMENSIONS OF THREE RAKE POINTING

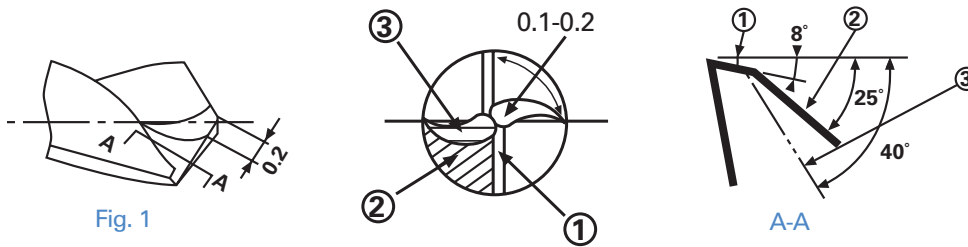

2. RE-SHARPENERS

The relief flank is re-sharpened in an ordered sequence.

- (1) The cutting tools are held parallel to the table.
- (2) The drill swings from the same horizontal plane, about 20 degrees (Fig.2).
- (3) The grinding wheel swings from the same number of degrees as the relief angle.
- (4) Re-sharpening relief flank (Fig.3).

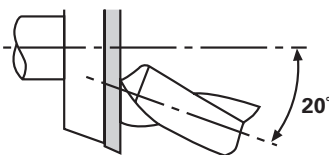

Fig. 2

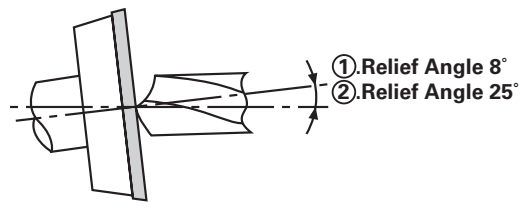

Fig. 3

3. THINNING (3RD RAKE)

The thinning is re-sharpened according to the following stipulations:

- (1) The drills rotate about 40 degrees towards the re-sharpening surface (Fig. 4).
- (2) The drills swings about 40 degrees (Fig. 5).
- (3) The thinning surface must be re-sharpened done at 0.1 to 0.2 mm (0.004-0.008") increments.

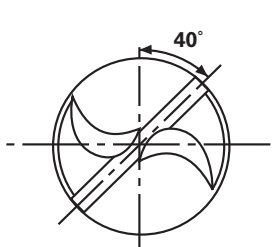

Fig. 4

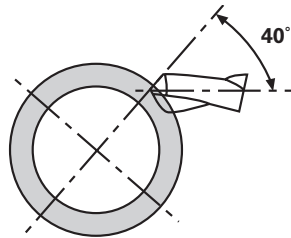
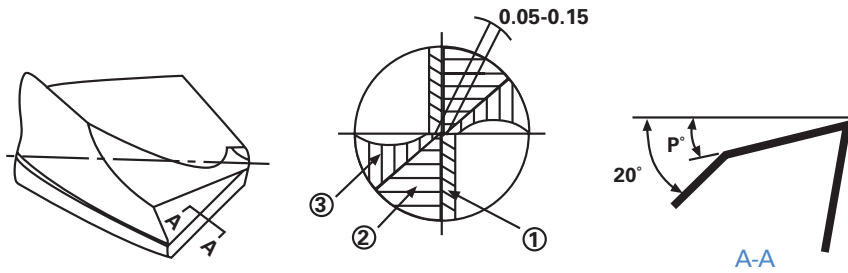

Fig. 5

SG-ES RE-SHARPENING

1. DIMENSIONS OF TWO-RAKE+X-THINNING



Diameter	P
2.0-5.0 (3/32-3/16)	12°
5.1-13.0 (13/64-1/2)	10°
13.1-20.0 (17/32-3/4)	8°

Table 1

2. GRINDING OF RELIEF FLANK

- 2-1. Utilize a drill grinder or a universal tool grinder
- 2-2. Grind relief flank as having 8 – 12 deg. as relief angle shown in Table 1. and Fig. 2.
- 2-3. Fix the drill after incline it. Then grind relief flank as having 20 deg. as secondary relief.
- 2-4. At this time, regrind it to meet the edgeline of these two relief in center line (Fig.3).

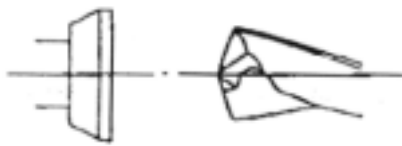

Fig. 1

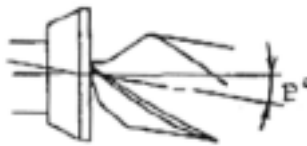

Fig. 2



Fig. 3

3. WEB THINNING

- 3-1. As shown Fig. 4, incline drill in 50-55 deg. then grind the corner of secondary relief remaining .05-.1 mm (.002-.004 in.). At this time, give attention not to grind the center of drill, then remain approx. 0.1 mm (.004 in.).
- 3-2. Rotate drill in 10 – 15 deg., then grind it. And secure the pocket of 105 – 110 deg.

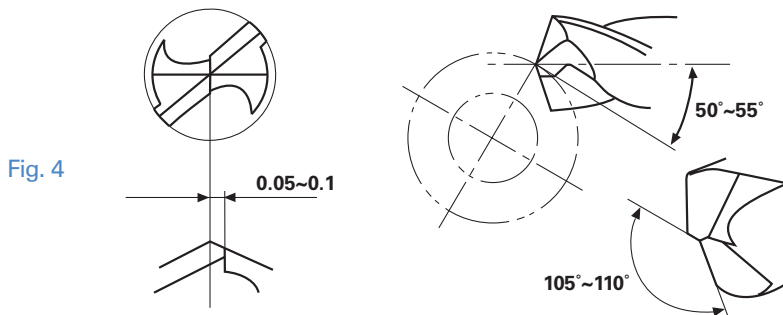

Fig. 4

4. INSPECTION

Please check the following points before using.

- 4-1. Lip height exist within 0.02 mm. (0.001 in.).
- 4-2. No remainder of damage on cutting edges after regrind.
- 4-3. Burr by regrind is removed.

Technical Data

DRILLS

DRILLS
Cutting Condition

END MILLS

END MILLS
Cutting Condition

TAPS

TAPS
Cutting Condition

Others

GUIDELINES FOR TROUBLE SHOOTING TWIST DRILL PROBLEMS

- Remedial measure is highly effective
- Remedial measure is relatively effective

Possible Cause								
Trouble with device	Faulty jig, clamp, or fixture	Faulty tool (design)	Faulty tool (regrinding)	Faulty tool holder	Defect in workplace	Unsatisfactory cutting conditions	Faulty coolant or lubricating system	Faulty process design

Problems	Solution	Remedy											
Oversize holes	Reduce material build up on cutting lips and flutes				22	24		29 30 31 32					
	Reduce difference in cutting resistance between Right and left cutting lips.	4	5B	7	13B	19	20	21	8				
Curved hole or drilled off center	Prevent defective leading	3	4	5B	7	13A	21	8		26B	27	6	33
	Increase drill rigidity				10								
	Reduce difference in cutting resistance between right and left cutting lips.					17B	19						
Distorted Holes	Prevent rifling		4			18B	19						
	Reduce irregular motion and vibration		3	7	23	20	21	8		26A			33
	Eliminate clogging with chips				9A	11	14	15					34
Hole position shift		3	4			20	21	8		27			33
Rough Finish or tearing in hole	Reduce galling (material build up on cutting lips)					22			24		29 30 31 32		
	Reduce wear					13A	19			25B			
	Reduce chatter and vibration	1	4	7	9A	23	20	21		26A			33
Breakage of drill	Eliminate clogging with chips				9A	11	14	15		26A	36		34
	Increase drill rigidity				10	23	17			26B			
	Reduce feed at breakthrough	1	2	7		20	18			28			
	Prevent drill deflection		3	4	5B	7	13A	19	21		26B		
Abnormal wear of drill corner edge	Reduce wear				12	16	18A		24	25B	26B		
	Prevent chipping	2	7							26B			
Wrapping of chip around drill	Increase or decrease helix angle and cutting speed from the recommended angle and speed	34	5A		9					26A			

GUIDELINES FOR TROUBLE SHOOTING TWIST DRILL PROBLEMS continued

No.	Remedial action and important points	No.	Remedial action and important points
1	Increase rigidity (column and spindle) of machine tool.	19	Eliminate relative lip height (difference in cutting resistance between right and left cutting edges).
2	Take steps to insure a steady feed (particularly components with pneumatic or hydraulic controls).	20	Thinning (take care to prevent excessive thinning).
3	Increase accuracy of alignment of bushing. (Increase alignment of preliminary hole and spindle for hole with large diameter.)	21	Eliminate unevenly chiseled areas.
4	Use bushing and reduce bushing clearance.	22	Rework worn margin completely.
5	Clearance between workpiece to be drilled and bushing 5A: Widen this clearance. 5B: Narrow this clearance.	23	Increase web thickness.
6	Rotate workpiece instead of tool.	24	Check workpiece to be drilled, for proper grain structure and heat treatment. (HB: 180 or more)
7	Secure workpiece or replace fixture on the workpiece with fittings that have less clamp distortion.	25	Cutting speed 25A: Increase this speed. 25B: Decrease this speed.
8	Check contact of drill taper (clean) and reduce run-out of holder and spindle.	26	Feed 26A: Increase feed rate. 26B: Decrease feed rate.
9	Helix angle 9A: Increase this angle. 9B: Decrease this angle.	27	Decrease feed at entrance to workpiece.
10	Shorten overall length and flute length to increase rigidity.	28	Decrease feed at exit from workpiece.
11	Provide chipbreaker.	29	Use non-water-soluble coolant.
12	Use surface treatment.	30	Use sulfuric or chloric extreme-pressure oils.
13	Point angle	31	Increase quantity of coolant discharged.
13A:	Increase this angle	32	Feed oil in correct direction.
13B:	Decrease this angle.	33	Drill center hole in preceding process.
14	Increase flute width ratio.	34	Effect intermittent feed. (Narrow step for deep holes.)
15	Use oil-hole drill.	35	Select such helix angle and end angle that cutting edges will not be shaped like beak.
16	Upgrade material of tool.	36	Decrease feed rate for deep holes
17	Back taper 17A: Increase back taper. 17B: Decrease back taper (Check a slight decrease in diameter from point to back).		
18	Lip relief angle 18A: Increase this angle. 18B: Decrease this angle.		

Technical Data

DRILLS

DRILLS
Cutting Condition

END MILLS

END MILLS
Cutting Condition

TAPS

TAPS
Cutting Condition

Others

Technical Data

DRILLS

DRILLS Cutting Condition

END MILLS

END MILLS Cutting Condition

TAPS

TAPS Cutting Condition

Others

TAPER SHANK WITH TENON

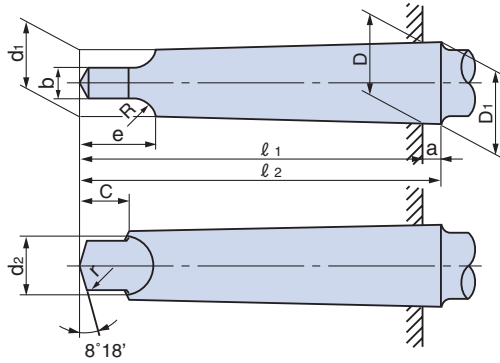

Morse taper	Taper		Angle on Side	Taper shank with tenon																
				D ⁽²⁾	a	D ₁ ⁽³⁾	d ₁ ⁽³⁾	d ₂		l ₁		l ₂		b		C ⁽⁴⁾	e		R	r
								Basic size	Tolerance	Basic size	Tolerance	Basic size	Tolerance	Basic size	Tolerance		Basic size	Tolerance	Basic size	
0	1/19.212	0.05205	1°29'27"	9.045	3	9.201	6.104	6	0 -0.3	56.5	0 -1.2	59.5	0 -1.9	3.9	0 -0.180	6.5	10.5	0 -1.1	4	1
1	1/20.047	0.04988	1°25'43"	12.065	3.5	12.240	8.972	8.7	0 -0.3	62.0	0 -1.2	65.5	0 -1.9	5.2	0 -0.180	8.5	13.5	0 -1.1	5	1.2
2	1/20.020	0.04995	1°25'50"	17.780	5	18.030	14.034	13.5	0 -0.43	75.0	0 -1.2	80	0 -1.9	6.3	0 -0.220	10	16	0 -1.1	6	1.6
3	1/19.922	0.05020	1°26'16"	23.825	5	24.076	19.107	18.5	0 -0.52	94.0	0 -1.4	99	0 -2.2	7.9	0 -0.220	13	20	0 -1.3	7	2
4	1/19.254	0.05194	1°29'15"	31.267	6.5	31.605	25.164	24.5	0 -0.52	117.5	0 -1.4	124	0 -2.5	11.9	0 -0.270	16	24	0 -1.3	8	2.5
5	1/19.002	0.05263	1°30'26"	44.399	6.5	44.741	36.531	35.7	0 -0.62	149.5	0 -1.6	156	0 -2.5	15.9	0 -0.270	19	29	0 -1.3	10	3
6	1/19.180	0.05214	1°29'36"	63.348	8	63.765	52.399	51.0	0 -0.74	210.0	0 -1.85	218	0 -2.9	19	0 -0.330	27	40	0 -1.6	13	4

Tolerance of Drill Diameter

Unit : 0.001mm

Diameter (mm)		Under 3.0 D≤3	Above 3.0 Under 6.0 3<D≤6	Above 6.0 Under 10 6<D≤10	Above 10 Under 18 10<D≤18	Above 18 Under 30 18<D≤30	Above 30 Under 50 30<D≤50	Above 50 Under 80 50<D≤80	Above 80 Under 120 80<D≤120
Tolerance	js6	±3	±4	±4.5	±5.5	±6.5	±8	±8.5	±11
	h6	0 -6	0 -8	0 -9	0 -11	0 -13	0 -16	0 -19	0 -22
	h7	0 -10	0 -12	0 -15	0 -18	0 -21	0 -25	0 -30	0 -35
	h8	0 -14	0 -18	0 -22	0 -27	0 -33	0 -39	0 -46	0 -54

NUMERICAL VALUES OF STANDARD TOLERANCE IT (JIS B 0401-1 : 1998 EXTRACT)

Unit : 0.001mm

Grades		Grades													
		IT 1	IT 2	IT 3	IT 4	IT 5	IT 6	IT 7	IT 8	IT 9	IT 10	IT 11	IT 12	IT 13	IT 14
Base size (mm)															
Above	Up to and including														
—	3	0.8	1.2	2	3	4	6	10	14	25	40	60	100	140	250
3	6	1	1.5	2.5	4	5	8	12	18	30	48	75	120	180	300
6	10	1	1.5	2.5	4	6	9	15	22	36	58	90	150	220	360
10	18	1.2	2	3	5	8	11	18	27	43	70	110	180	270	430
18	30	1.5	2.5	4	6	9	13	21	33	52	84	130	210	330	520
30	50	1.5	2.5	4	7	11	16	25	39	62	100	160	250	390	620
50	80	2	3	5	8	13	19	30	46	74	120	190	300	460	740
80	120	2.5	4	6	10	15	22	35	54	87	140	220	350	540	870
120	180	3.5	5	8	12	18	25	40	63	100	160	250	400	630	1000
180	250	4.5	7	10	14	20	29	46	72	115	185	290	460	720	1150
250	315	6	8	12	16	23	32	52	81	130	210	320	520	810	1300
315	400	7	9	13	18	25	36	57	89	140	230	360	570	890	1400
400	500	8	10	15	20	27	40	63	97	155	250	400	630	970	1550

TOLERANCE GRADE (JIS B 0401-1 : 1998 EXTRACT)

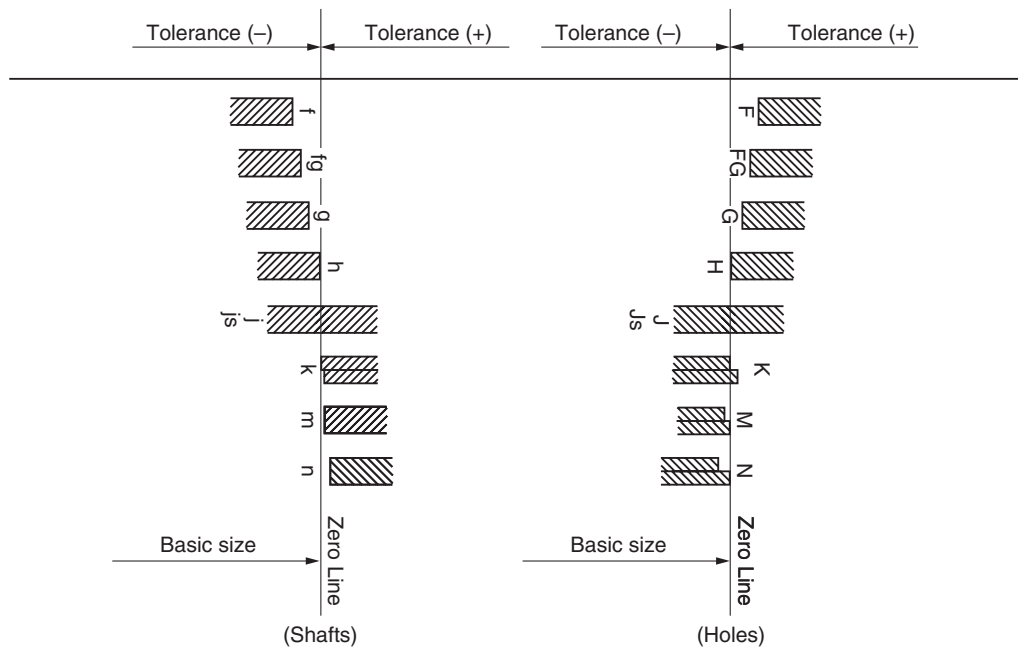

Technical Data

DRILLS

DRILLS
Cutting Condition

END MILLS

END MILLS
Cutting Condition

TAPS

TAPS
Cutting Condition

Others

The background features a large, stylized teal number '4' on the left side. The rest of the background is a light teal color with a subtle pattern of horizontal lines and a diagonal teal shape on the right. The text 'END MILLS' is centered horizontally and partially overlaid by the '4' and the diagonal shape.

END MILLS

Technical Data

DRILLS

DRILLS
Cutting Condition

END MILLS

END MILLS
Cutting Condition

TAPS

TAPS
Cutting Condition

Others

Features

- Sharp corner type solid carbide end mill.
- Smooth chip flow by GS coat, (New TiAlN coating).
- Multi purpose use and long tool life.

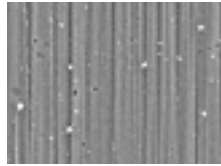

Ra=0.078μm
GS-mill
(Smooth surface !)

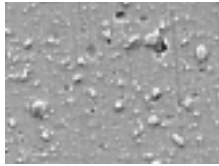

Ra=0.171μm
Competitor



Work Materials

Structural Steels, Carbon Steels, Alloy Steels, Pre-hardened Steels, Hardened Steels, Stainless Steels, Nickel Alloys, Titanium Alloys, Cast Irons

Performance

GS-mill Two Flute

Milling Condition

Dia. of Mill : ø8mm
Speed : 2,400min⁻¹
(198 SFM)
Feed : 190mm/min
(7.5 IPM)
Material : Pre-hardened Steels
Coolant : air blow
Milling Length : 30m

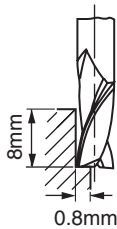

GS-mill Two Flute

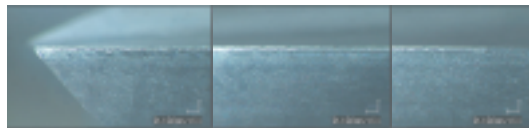

Competitor

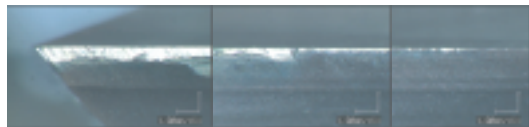

GS-mill ball

Milling Condition

Size of Mill : R4
Speed : 12,000min⁻¹
(990 SFM)
Feed : 1,910mm/min
(75.2 IPM)
Material : SCM440 (30HRC)
Coolant : air blow
Milling Length : 7m

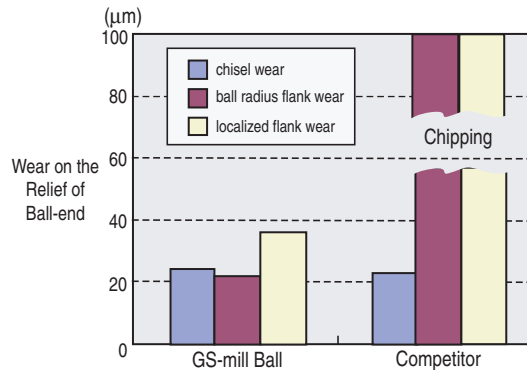
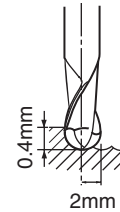

Stocked Size	End mills Name	List No.	Page
	GS-mills 2-Flute	9382	142
	GS-mills 4-Flute	9384	142
	GS-mills Ball	9386	143

Features

- Ultra highly precise end mill which realizes polishing less die & mold milling
- Ball tolerance $\pm 3\mu\text{m}$, Ball accuracy range 180°

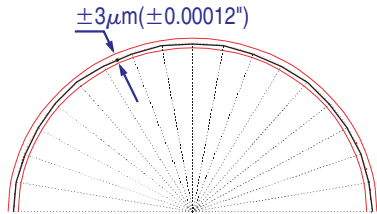

Enlarged R tolerance range from ball edge to outside cutting edge by seamless processing



- Combination of X's coat and micro grain hard metal which are suitable for mold & die steel, direct high-speed milling is possible

Work Materials

Mold steels, Pre-Hardened steels, Carbon steels, Alloy steels, Stainless steels, Nickel alloys, Titanium alloys, Cast Irons

Performance

Wear comparison

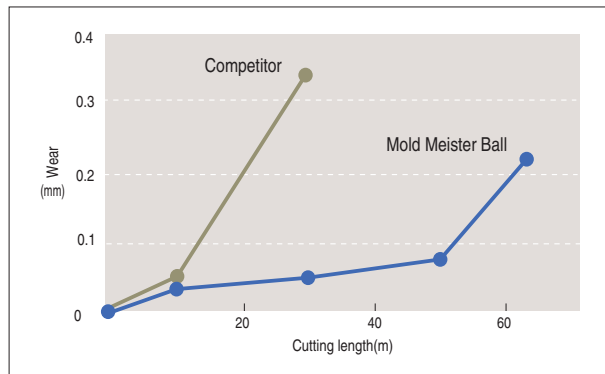

Gap actual survey value of milling surface

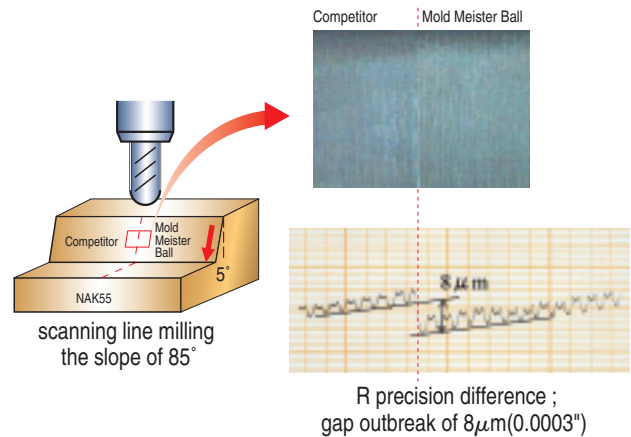

Milling Condition

Tool : R6(R0.236in)
 Cutting Speed : 200m/min(656 SFM)
 (5,300min⁻¹)
 Speed : 1.060mm/min(41.7 IPM)
 Work Material : D2(SKD11), 60HRC
 Cutting Fluid : Air blow

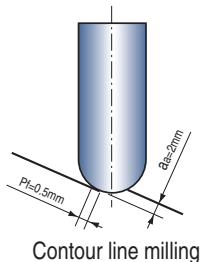

Stocked Size	End mills Name	List No.	Page
	Mold Meister Ball	9408	143

* JAPAN STOCK ITEM : Please allow 2-3 weeks delivery.

Technical Data

DRILLS

DRILLS
Cutting Condition

END MILLS

END MILLS
Cutting Condition

TAPS

TAPS
Cutting Condition

Others

Technical Data

DRILLS

DRILLS
Cutting Condition

END MILLS

END MILLS
Cutting Condition

TAPS

TAPS
Cutting Condition

Others

Features

- Realize ultra high speed milling of cutting speed 800m/min (2625 SFM)
- "GS Hard coat" of new development improves in heat resistance and wear resistance in Ultra high speed milling

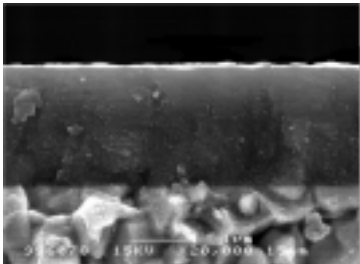

- Oxidation resistance coating
- Wear resistance coating
- High hardness carbide
- Microstructure enhances coating strength

- Chip removal excellent with smooth carve groove form High rigidity by wide lend width

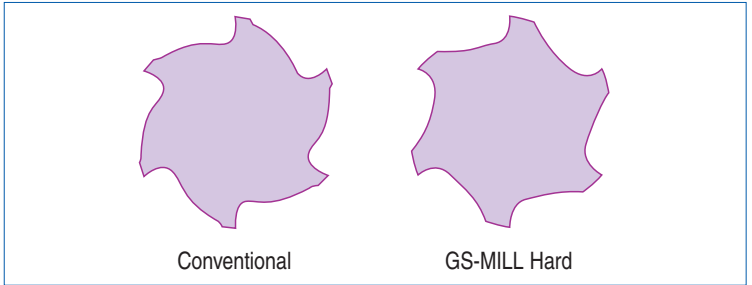

Work Materials

(Herdend steels of 45~70HRC)such as High speed steels, Alloy steels

Performance

Ultra-high-speed side milling $\phi 10\text{mm}$ (0.394in)(six flutes)
Reduce wear to 1/3 in cutting speed of 800m/min (2625 SFM)

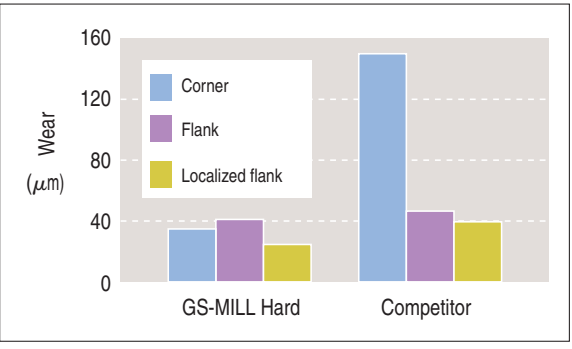
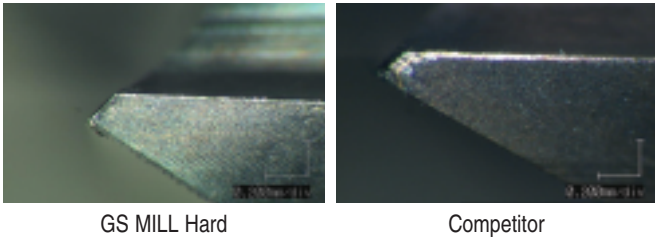

Milling condition

Tool : $\phi 10$ (0.394in)
Cutting Speed : 800m/min(2625 SFM)(25,000min⁻¹)
Feed : 10,500mm/min(413 IPM)
Work Material : H13(SKD61), 53HRC
Cutting Fluid : Air Blow
Milling Length : 75m(246FEET)

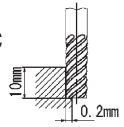

Stocked Size	End mills Name	List No.	Page
	GS-MILL Hard / Metric Sizes	9398	144
	GEO-MILL Hard / Inch Sizes	9399	145 NEW

Features

- **Durable tool life by newly developed coating**
Newly developed smooth coating makes kinetic friction smaller and improves wear resistance.
- **Optimal for hardened steel milling**
Ultra micro grain carbide with low Cobalt content suppresses micro plastic deformation during milling and increase tool life.
- **High accuracy ball nose +3~-7μm**
Realize high accuracy ball nose by "One-Pass" grinding process and precise milling is possible.



Technical Data
DRILLS
DRILLS Cutting Condition

Work Materials

Hardened Steels(45~65HRC), Pre-Hardened Steels, Mold Steels, High Speed Steels

New Coating

Smoothness and heat resistance are combined

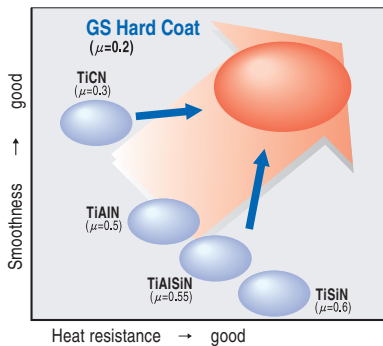

Improves wear resistance

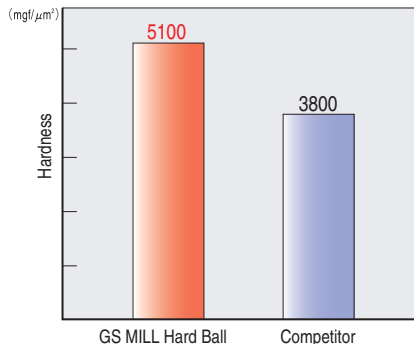

Performance

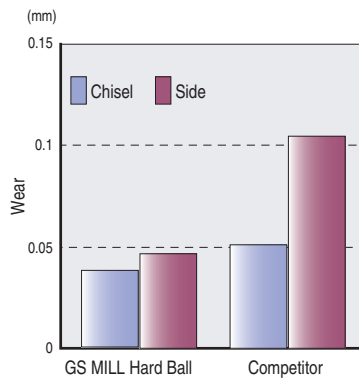

Milling Condition

Tool : R3 mm
Cutting Speed : 213 SFM (65m/min)
3450 RPM
Feed : 16.3 IPM (414mm/min)
Work Material : D2 (SKD11) 60HRC
Milling Length : 197 Feet (60m)
Cutting Fluid : Dry Air Blow
 *a*_a : 0.012" (0.3mm)
 *P*_f : 0.012" (0.3mm)

Stocked Size	End mills Name	List No.	Page
	GS-MILL Hard Ball / Metric Sizes	9422	144
	GEO-MILL Hard Ball / Inch Sizes	9423	145 NEW

* JAPAN STOCK ITEM : Please allow 2-3 weeks delivery.

END MILLS

END MILLS Cutting Condition

TAPS

TAPS Cutting Condition

Others

Technical Data

DRILLS

DRILLS Cutting Condition

END MILLS

END MILLS Cutting Condition

TAPS

TAPS Cutting Condition

Others

Features

- Utilizes flute geometry resulting in fast groove milling and excellent chip ejection.
- Tough micro grain carbide enables a longer tool life.
- TiAlN coating has high heat resistance that enhances a longer tool life.
- Multi-functional end mill that allows high speed grooving and highly precise side milling.

Chip form to flow smoothly



Cross section of geo mill

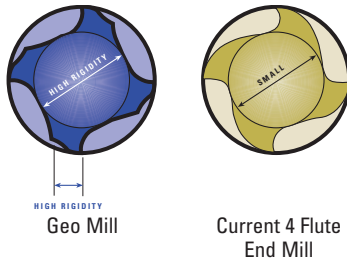

Work Materials

Carbon Steels, Alloy Steels, Pre-Hardened Steels, Hardened Steels, Stainless Steels, Nickel Alloys, Titanium Alloys, Cast Irons

Performance

CUTTING ABILITY- NACHI'S GEO MILL VS. OTHER BRAND

Milling Condition

Dia. of Mill : 10mm 4flute
 Speed : 1,600min⁻¹ (165 SFM)
 Feed : 256mm/min (10 IPM)
 Material : SKD61 (40HRC)
 Coolant : DRY
 Cutting Length : 7.5m (25feet)

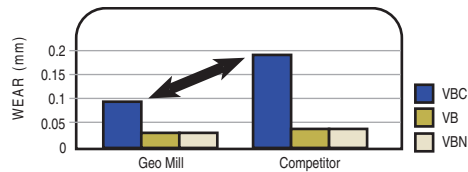
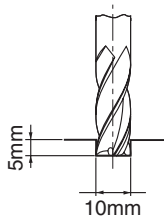

Corner Wear is Reduced by 50%

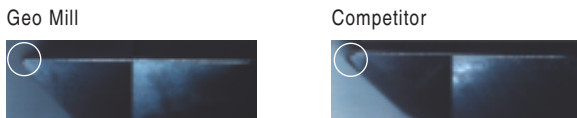

SURFACE ROUGHNESS (UNDULATION & INCLINATION)-NACHI GEO MILL VS. OTHER BRANDS

Milling Condition

Dia. of Mill : 3/8 4flute
 Speed : 2,800min⁻¹ (275 SFM)
 Feed : 1,000mm/min (39.4 IPM)
 Material : Carbon (28HRC)
 Coolant : DRY
 Cutting Length : 27m (90feet)

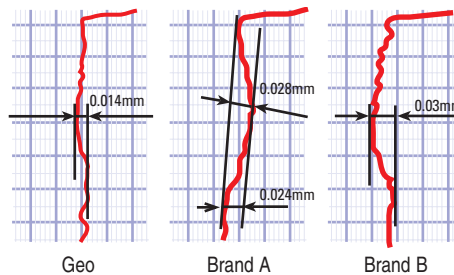
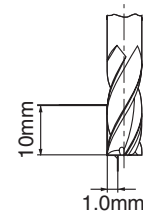

Stocked Size	End mills Name	List No.	Page
*	X's-mill Geo / Metric Sizes	9322	146
	X's-mill Geo / Inch Sizes	9321	147
*	X's-mill Geo Radius	9324	148

Stocked Size	End mills Name	List No.	Page
	X's-mill Geo SLOT	9338	149
*	X's-mill Geo KV	9366 9368	150

* JAPAN STOCK ITEM : Please allow 2-3 weeks delivery.

Features

- It can be processed into grooving continuously from slotting
- 3-4 times faster grooving than conventional end mill
- By the adoption of the end teeth which has excellent chip flow and well-balanced three flutes, efficient slotting is possible.
- Non-step slotting of 1D depth is possible.

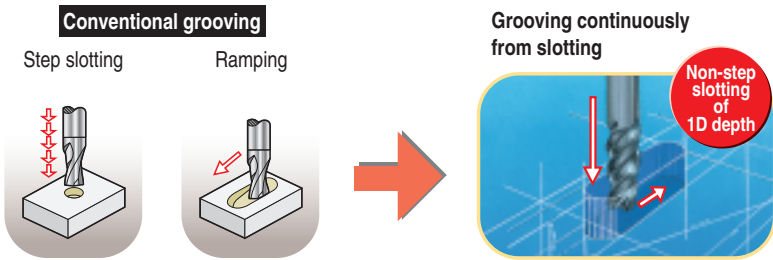
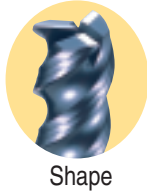

Work Materials

Carbon Steels, Alloy Steels, Pre-hardened Steels, Hardened Steels, Stainless Steels, Nickel Alloys, Titanium Alloys, Cast Irons

Performance

Slotting and grooving

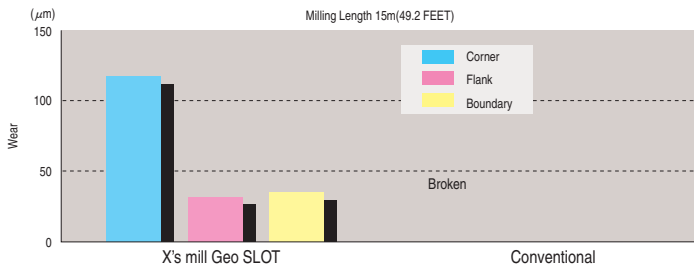

Milling Condition

End Mill : 10mm (0.394in)
 Cutting Speed : 80m/min (263 SFM) (2,550min⁻¹)
 Feed : Slotting 200mm/min (7.9 IPM) (0.08mm/rev)(0.003 IPR)
 Grooving 1,000mm/min (39.4 IPM) (0.1mm/tooth)(0.004 IPT)
 Depth : 10mm (0.394in)
 Milling Length : 50mm (1.969in)
 Nus of Groove : 300grooves
 Mork Material : D2(SKD11), 180HB
 Cutting Fluid : Air blow

Cutting resistance when slotted

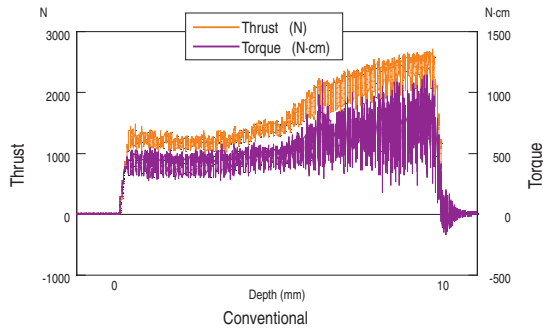
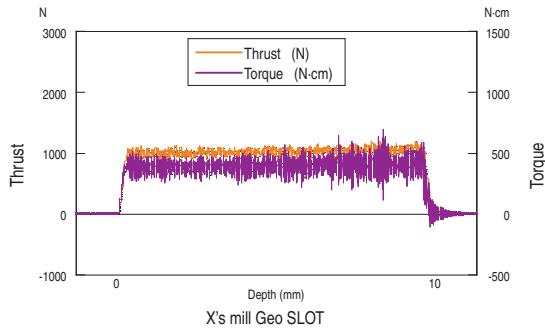

Stocked Size	End mills Name	List No.	Page
	X's-mill Geo SLOT	9338	149

* JAPAN STOCK ITEM : Please allow 2-3 weeks delivery.

Technical Data

DRILLS

DRILLS Cutting Condition

END MILLS

END MILLS Cutting Condition

TAPS

TAPS Cutting Condition

Others

Technical Data

Features

- Excellent surface finish.
"DLC" (Diamond like carbon) coating has low friction.
- Designed for dry-milling.
Excellent chip control due to special flute geometry.

DRILLS

Work Materials

Aluminums, Aluminum Alloys, Aluminum Alloy Casting, Aluminum Alloy Die-casting, Copper Alloys

DRILLS Cutting Condition

Performance

Milling Condition

Dia. of Mill : 10mm
Speed : 10,000min⁻¹ (1,030 SFM)
Feed : 1,000mm/min (39.4 IPM)
Material : AA5052
Coolant : Dry



END MILLS

Milled with DLC coated endmill

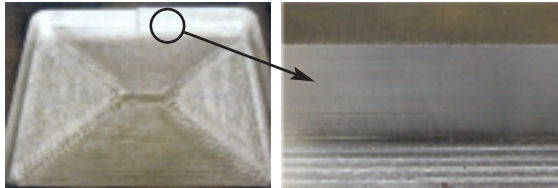

Excellent surface finish without burr



Condition of tool after operation

Breakage



Milling with un-coated carbide end mill

END MILLS Cutting Condition

AA5052	DLC mill	Non-coated carbide
Surface Finish		
Surface Roughness	 Ry=4.550 μm	 Ry=31.50 μm

DLC mill maintains very good surface finish!!

TAPS

TAPS Cutting Condition

Others

Stocked Size	End mills Name	List No.	Page
	DLC-mill for Aluminum	9330	153
*	DLC-mill Sharp Corner Two Flute	9378	153
*	DLC-mill Radius	9302	154
*	DLC-mill Slot Long Shank	9390	155
*	DLC-mill Ball	9360	156
*	DLC-HSS mill / Metric Sizes	6450	157
	DLC-HSS mill / Inch Sizes	6231HD	157

* JAPAN STOCK ITEM : Please allow 2-3 weeks delivery.

Features

- Super HSS of new development and AG coating by new process.
- Cost performance of rough, semi-finish milling.
- Fine pitch nick and Heavy nick that a chip break is good, and there is high depth of cut.

Comparison of cutting chips

	AG-mill Roughing	Competitor
early time		
After 5m cutting		



Technical Data

DRILLS

DRILLS Cutting Condition

Work Materials

Carbon steels, Alloy steels, Mold Steels, Pre-Hardened steels, Stainless steels, Nickel alloys, Cast Irons, Aluminum alloys

Performance

Excellent chipping-resistant / Wear-resistant

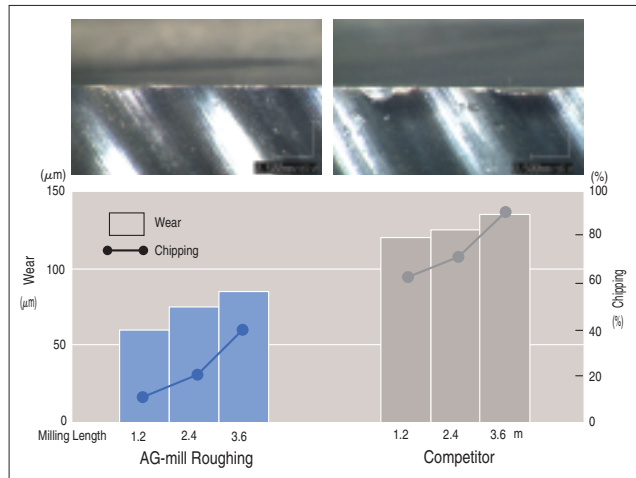

Milling condition

Tool : $\phi 20(0.787\text{in})$ (AGRERS)
 Cutting Speed : 40m/min(131 SFM)
 Feed : 0.1mm/tooth(0.004 IPT)
 Work Material : 1050(S50C), 180HB
 Cutting Fluid : Wet

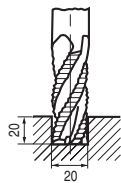

Side milling of AG-mill Roughing

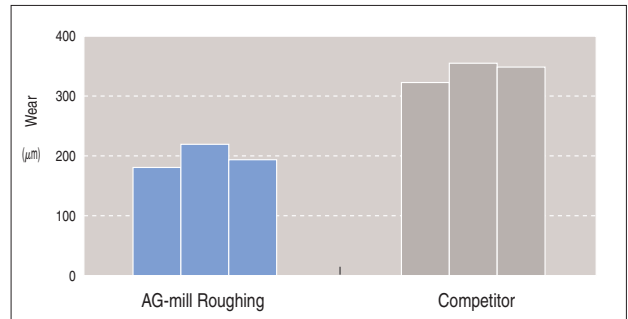

Milling condition

Tool : $\phi 20(0.787\text{in})$ (AGRERS)
 Cutting Speed : 355min⁻¹(22m/min)(72.1 SFM)
 Feed : 132mm/min(5.20 IPM)
 Work Material : D2(SKD11), 210HB
 Cutting Fluid : Wet

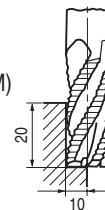

Stocked Size	End mills Name	List No.	Page
	AG-mill Roughing / Inch Sizes	6485	158
	AG-mill Heavy / Inch Sizes	6403	158

Stocked Size	End mills Name	List No.	Page
	AG-mill Roughing Short	6406	159
	AG-mill Roughing Regular Length Short	6484	159
	AG-mill Roughing Medium	6486	160
	AG-mill Roughing Long	6488	160
	AG-mill Heavy	6402	161
	AG-mill Heavy Long	6404	162

* JAPAN STOCK ITEM : Please allow 2-3 weeks delivery.

END MILLS

END MILLS Cutting Condition

TAPS

TAPS Cutting Condition

Others

HIGH PERFORMANCE END-MILLS

Endmills Name	Material	Coating		Stock Size	Stock USA ● Japan ○	LIST No		Image
						Page Size	Page Cutting Condition	
GS-mill 2-Flute	Solid carbide	GS	Metric	0.5 to 12.0	●	9382 p.142 p.177		
GS-mill 4-Flute			Metric	1.0 to 12.0	●	9384 p.142 p.177		
GS-mill Ball			Metric	R0.5 to R6	●	9386 p.143 p.178		
GS-mill Hard		GS Hard	Metric	1.0 to 20.0	●	9398 p.144 p.179		
GS-mill Hard Ball			Metric	R0.2 to R6	○	9422 p.144 p.181		
GEO-mill Hard NEW			Inch	1/4 to 3/4	●	9399 p.145 p.180		
GEO-mill Hard Ball NEW			Inch	1/32 to 3/8	●	9423 p.145 p.181		
Mold Meister Ball		X's	Metric	R0.5 to R6	○	9408 p.143 p.184		
X's-mill Geo			Inch	1/8 to 1	●	9321 p.147 p.182		
			Metric	2.0 to 32.0	○	9322 p.146 p.182		
X's-mill Geo Radius			Metric	3.0 to 20.0	○	9324 p.148 p.182		
X's-mill Geo SLOT			Metric	1.0 to 16.0	●	9338 p.149 p.183		
X's-mill Geo KV 2-Flute			Metric	0.5 to 3.0	○	9366 p.150 p.186		
X's-mill Geo KV 4-Flute			Metric	1.0 to 3.0	○	9368 p.150 p.186		
X's-mill Geo Ball			Metric	R0.5 to R15	○	9340 p.151 p.184		
X's-mill Geo Microball			Metric	R0.1 to R2	○	9332 p.152 p.185		
DLC-mill			DLC	Metric	1.0 to 20.0	●	9330 p.153 p.187	
DLC-mill Sharp Corner		Metric		1.0 to 20.0	○	9378 p.153 p.187		
DLC-mill Radius		Metric		2.0 to 20.0	○	9302 p.154 p.187		
DLC-mill Slot Long Shank		Metric		2.0 to 20.0	○	9390 p.155 p.187		
DLC-mill Ball	Metric	R0.5 to R10		○	9360 p.156 p.190			
DLC-HSS mill	Inch	1/8 to 1		●	6231HD p.157 p.191			
DLC-HSS mill	Metric	1.0 to 20.0		○	6450 p.157 p.191			

Technical Data
DRILLS
DRILLS Cutting Condition
END MILLS
END MILLS Cutting Condition
TAPS
TAPS Cutting Condition
Others

●:Great ○:Good △:OK

	Side Milling			Grooving			Profile Milling	Rib Process	Workpiece Material																	
	Rough	Semi-Finish	Finish	Rough	Semi-Finish	Finish			Structural Steel	Carbon Steel		Alloy Steel	Pre-hardened Steel	Die Steel HRC 30 to 45	Hardend Steel HRC			Stainless Steel		Titanium Alloys	Nickel Alloys	Cast Iron	Aluminum		Copper Alloys	Graphite
										Low Carbon 1010,1018	High Carbon 1045,1065				45 to 55	55 to 60	60 to 65	Austenitic 300 Series	Martensitic 400 Series				Casting Si ≤ 12%	High Si >13%		
		●	●		●	●			●	●	●	●	●	○		●	●	○	○	○						
		●	●		●	●			●	●	●	●	●	○		●	●	○	○	○						
							●		●	●	●	●	●			●	●	○	○	○						
			●						●	●	●	●	●	●		○	○	○	○	○						
							●				○	○	●	●	●											
			●						●	●	●	●	●	●		○	○	○	○	○						
							●		●	●	●	●	●			●	●	○	○	○						
		●	●		●	●			●	●	●	●	●	○		●	●	○	○	○						
		●	●		●	●			●	●	●	●	●			●	●	○	○	○						
									△							●	●	●	●							
									△							●	●	○	○							
							●		●	●	●	●	●			●	●	○	○	○						
							●		●	●	●	●	●			●	●	○	○	○						
		●	●		●	●															●	○	○			
		●	●		●	●															●	○	○			
							●														●	○	○			
	○	●	●	●	●	●															●	○	○			
							●														●	○	○			
		●	●		●	●															●	○	○			
		●	●		●	●															●	○	○			

Technical Data

DRILLS

DRILLS Cutting Condition

END MILLS

END MILLS Cutting Condition

TAPS

TAPS Cutting Condition

Others

Endmills / Selection Chart

HIGH PERFORMANCE END-MILLS

Endmills Name		Material	Coating		Stock Size	Stock USA ● Japan ○	LIST No		Image
							Page Size	Page Cutting Condition	
AG-mill Roughing	Short	HSS-Co	AG	Inch	1/4 to 2	●	6485		
				Metric	6.0 to 50.0	○	p.158	p.192	
	Regular Length Short			Metric	6.0 to 50.0	○	6484		
				Metric	6.0 to 50.0	○	p.159	p.192	
				Metric	6.0 to 50.0	○	p.160	p.192	
Long	Metric			6.0 to 50.0	○	6403			
	Metric			6.0 to 50.0	○	p.158	p.193		
AG-mill Heavy	Long			Metric	3.0 to 50.0	○	6402		
				Metric	3.0 to 50.0	○	p.161	p.193	
				Metric	3.0 to 50.0	○	p.162	p.193	

COATED END-MILLS

Endmills Name		Material	Coating		Stock Size	Stock USA ● Japan ○	LIST No		Image
							Page Size	Page Cutting Condition	
GENAC-Mill	2-Flute / Regular	Solid carbide	SG	Inch	1/8 to 1	●	9261X		
	2-Flute / Long			Inch	1/8 to 1	● *	p.163	p.194	
	2-Flute / Regular - Ball End			Inch	1/8 to 1	●	9271X		
	2-Flute / Long-Ball End			Inch	1/8 to 1	● *	p.163	p.195	
	4-Flute / Regular			Inch	1/8 to 1	●	9263X		
	4-Flute / Long			Inch	1/8 to 1	●	p.163	p.194	
	4-Flute / Regular - Ball End			Inch	1/8 to 1	●	9273X		
	4-Flute / Long - Ball End			Inch	1/8 to 1	● *	p.163	p.195	
	Roughing, Regular, Center Cutting			Inch	1/4 to 1-1/4	●	9251X		
	High Helix, 3-Flute			Inch	1/8 to 1	● *	p.164	p.196	
				Inch	1/8 to 1	● *	p.164	p.196	

* : Discontinued items

Technical Data

DRILLS

DRILLS Cutting Condition

END MILLS

END MILLS Cutting Condition

TAPS

TAPS Cutting Condition

Others

●:Great ○:Good △:OK

	Side Milling			Grooving			Profile Milling	Rib Process	Workpiece Material																	
	Rough	Semi-Finish	Finish	Rough	Semi-Finish	Finish			Structural Steel	Carbon Steel		Alloy Steel	Pre-hardened Steel	Die Steel HRC 30 to 45	Hardend Steel			Stainless Steel		Titanium Alloys	Nickel Alloys	Cast Iron	Aluminum		Copper Alloys	Graphite
										Low Carbon 1010,1018	High Carbon 1045,1065				HRC 45 to 55	55 to 60	60 to 65	Austenitic 300 Series	Martensitic 400 Series				Casting Si ≤ 12%	High Si >13%		
	●			●					●	●	●	●	○	○			●	●	●	●	○	○		○		
	●			●					●	●	●	●	○	○			●	●	●	●	○	○		○		
	●			●					●	●	●	●	○	○			●	●	●	●	○	○		○		
	●			●					●	●	●	●	○	○			●	●	●	●	○	○		○		
	●	●		●	●				●	●	●	●	○	○			●	●	●	●	○	○		○		
	●	●		●	●				●	●	●	●	○	○			●	●	●	●	○	○		○		

Technical Data

DRILLS

DRILLS Cutting Condition

END MILLS

●:Great ○:Good △:OK

	Side Milling			Grooving			Profile Milling	Rib Process	Workpiece Material																	
	Rough	Semi-Finish	Finish	Rough	Semi-Finish	Finish			Structural Steel	Carbon Steel		Alloy Steel	Pre-hardened Steel	Die Steel HRC 30 to 45	Hardend Steel			Stainless Steel		Titanium Alloys	Nickel Alloys	Cast Iron	Aluminum		Copper Alloys	Graphite
										Low Carbon 1010,1018	High Carbon 1045,1065				HRC 45 to 55	55 to 60	60 to 65	Austenitic 300 Series	Martensitic 400 Series				Casting Si ≤ 12%	High Si >13%		
					○	●			○	●	●	●	○	●	△		△	△	△	△	○			△		
					○	●			○	●	●	●	○	●	△		△	△	△	△	○			△		
							●		○	●	●	●	○	●	△		△	△	△	△	○			△		
							●		○	●	●	●	○	●	△		△	△	△	△	○			△		
		○	●			△			○	●	●	●	○	●	△		△	△	△	△	○			△		
		○	●			△			○	●	●	●	○	●	△		△	△	△	△	○			△		
							●		○	●	●	●	○	●	△		△	△	△	△	○			△		
							●		○	●	●	●	○	●	△		△	△	△	△	○			△		
	●			●					○	●	●	●	○	●	△		△	△	△	△	○			△		
				○	●				○	●	●	●	○	●	△		△	△	△	△	○			△		

END MILLS Cutting Condition





TAPS

TAPS Cutting Condition















Others

Endmills / Selection Chart

COATED END-MILLS

Endmills Name	Material	Coating	Inch	Stock Size	Stock USA ● Japan ○	LIST No		Image
						Page Size	Page Cutting Condition	
SG 2-Flute / Regular	HSS-Co	SG	Inch	1/8 to 1-1/2	●	6231X p.169 p.197		
SG Multi-Flute / Regular, Center Cutting			Inch	1/8 to 1-1/2	●	6211X p.173 p.198		
SG Roughing & Finishing (Heavy Duty)			Inch	1/4 to 2	●	6367X p.166 p.199		
SG Roughing (Hog)			Inch	1/4 to 2	●	6303X p.167 p.199		

NON COATED END-MILLS

Endmills Name	Material	Coating	Inch	Stock Size	Stock USA ● Japan ○	LIST No		Image	
						Page Size	Page Cutting Condition		
2-Flute Single End	HSS		Inch	1/8 to 2-1/2	● *	231 p.169 p.200			
			Inch	1/8 to 2	●	6231 p.169 p.200			
	HSS-Co		Inch	1/4 to 2	●	6233 p.170 p.200			
2-Flute Double End	HSS		Inch	1/8 to 1	● *	261 p.171 p.200			
			Metric	1.0 to 50.0	● ○	6230 p.172 p.200			
4-Flute Single End	HSS		Inch	1/8 to 2	● *	211 p.173 p.201			
			Inch	1/4 to 2	● *	213 p.174 p.201			
	HSS-Co		Inch	1/4 to 1-1/4	●	6213 p.174 p.201			
	HSS		Inch	1/4 to 1-1/4	● *	215 p.175 p.201			
4-Flute Double End	HSS		Inch	1/8 to 1	● *	271 p.176 p.201			
			Metric	2.5 to 50.0	● ○	6210 p.172 p.201			
Multi-Flute	HSS-Co		Inch	1/8 to 2	●	6211M p.173 p.201			
Roughing & Finishing (Heavy Duty)			Inch	1/4 to 3	●	6367 p.166 p.203			
Roughing (Hog)			Bright Finish	Inch	1/4 to 2	●	6303 p.167 p.203		
			Fine Pitch	Inch	1/4 to 2	●	6307 p.168 p.203		

* : Discontinued items

Technical Data

DRILLS

DRILLS Cutting Condition

END MILLS

END MILLS Cutting Condition

TAPS

TAPS Cutting Condition

Others

●:Great ○:Good △:OK

	Side Milling			Grooving			Profile Milling	Rib Process	Workpiece Material																		
	Rough	Semi-Finish	Finish	Rough	Semi-Finish	Finish			Structural Steel	Carbon Steel		Alloy Steel	Pre-hardened Steel	Die Steel HRc 30 to 45	Hardend Steel			Stainless Steel		Titanium Alloys	Nickel Alloys	Cast Iron	Aluminum		Copper Alloys	Graphite	
										Low Carbon 1010,1018	High Carbon 1045,1065				HRC	45 to 55	55 to 60	60 to 65	Austenitic 300 Series				Martensitic 400 Series	Casting Si ≤ 12%			High Si Si > 13%
					○	●			●	●	●	○	○							△	△	△	△				
		○	●						●	●	●	○	○							△	△	△	△				
	●	●		●	●				●	●	●	○	○							△	△	△	△				
	●			●					●	●	●	○	○							△	△	△	△				

●:Great ○:Good △:OK

	Side Milling			Grooving			Profile Milling	Rib Process	Workpiece Material																		
	Rough	Semi-Finish	Finish	Rough	Semi-Finish	Finish			Structural Steel	Carbon Steel		Alloy Steel	Pre-hardened Steel	Die Steel HRc 30 to 45	Hardend Steel			Stainless Steel		Titanium Alloys	Nickel Alloys	Cast Iron	Aluminum		Copper Alloys	Graphite	
										Low Carbon 1010,1018	High Carbon 1045,1065				HRC	45 to 55	55 to 60	60 to 65	Austenitic 300 Series				Martensitic 400 Series	Casting Si ≤ 12%			High Si Si > 13%
					○	○			△	△	△	△	△							△	△	△	△				
					○	○			○	○	○	○	○							○	△	△	○				
					○	○			○	○	○	○	○							○	△	△	○				
					○	○			○	○	○	○	○							○	△	△	○				
					○	○			△	△	△	△	△							△	△	△	△				
		○	○			△			△	△	△	△	△							△	△	△	△				
		○	○			△			△	△	△	△	△							△	△	△	△				
		○	○			△			△	△	△	△	△							△	△	△	△				
		○	○			△			○	○	○	○	○							○	△	△	○				
		○	○			△			○	○	○	○	○							○	△	△	○				
		○				○			○	○	○	○	○							○	△	△	○				
		○				○			○	○	○	○	○							○	△	△	○				

Technical Data

DRILLS

DRILLS
Cutting Condition

END MILLS

END MILLS
Cutting Condition

TAPS

TAPS
Cutting Condition

Others

GS-MILL TWO FLUTE

GS-MILL FOUR FLUTE

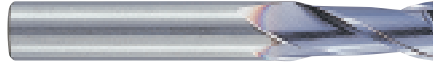
Technical
Data**List No.9382 Two Flute**

This end mill having sharp edge corner is suitable for high-speed and long life milling of workpiece materials from raw materials to hardened materials, and is used in grooving.

(Unit) : mm

Dia. of Mill	Shank Dia.	Length of Cut	Overall Length
0.5	3	1.25	38
1	3	2.5	38
1.5	3	3.75	38
2	3	5	38
2.5	3	6.25	38
3	3	7.5	38
4	4	11	45
5	6	13	50
6	6	13	50
8	8	19	60
10	10	22	70
12	12	26	75

DRILLS

DRILLS
Cutting Condition

END MILLS

END MILLS
Cutting Condition

Dia. of Mill (mm)		Tolerance (mm)
Above	Up to	
	3	0~-0.015
3		0~-0.020

1 per tube

List No.9384 Four Flute

This end mill having sharp edge corner is suitable for high-speed and long life milling of workpiece materials from raw materials to hardened materials, and is used in side milling.

(Unit) : mm

Dia. of Mill	Shank Dia.	Length of Cut	Overall Length
1	3	2.5	38
2	3	5	38
3	3	7.5	38
4	4	11	45
5	6	13	50
6	6	13	50
8	8	19	60
10	10	22	70
12	12	26	75

TAPS

TAPS
Cutting Condition

Others

Dia. of Mill (mm)		Tolerance (mm)
Above	Up to	
	3	0~-0.015
3		0~-0.020

1 per tube

GS-MILL BALL MOLD MEISTER BALL

List No.9386 GS-MILL BALL



This end mill is suitable for high-speed and long life milling, and is used in profile milling.

(Unit) : mm

Ball Radius	Dia. of Mill	Shank Dia.	Length of Cut	Overall Length
0.5	1	4	1.5	50
0.75	1.5	4	2.5	50
1	2	6	3	60
1.25	2.5	6	4	60
1.5	3	6	4.5	60
2	4	6	6	70
2.5	5	6	7.5	80
3	6	6	9	80
4	8	8	12	90
5	10	10	15	100
6	12	12	21	110

Tolerance (mm)	
Dia. of Mill	Ball Radius
0~-0.03	±0.01

1 per tube

List No.9408 MOLD MEISTER BALL



This end mill is the best in manual polish less milling of precise die and mold. Ball tolerance ±3μm. Ball accuracy range 180°.

(Unit) : mm

Ball Radius	Dia. of Mill	Shank Dia.	Length of Cut	Overall Length
0.5	1	4	1.5	50
0.75	1.5	4	2.5	50
1	2	6	3	60
1.25	2.5	6	4	60
1.5	3	6	4.5	80
2	4	6	6	80
2.5	5	6	7.5	90
3	6	6	9	100
4	8	8	12	100
5	10	10	15	120
6	12	12	18	120

Tolerance (mm)	
Dia. of Mill	Ball Radius
±0.006	±0.003

1 per tube

* JAPAN STOCK ITEM : Please allow 2-3 weeks delivery

Technical Data

DRILLS

DRILLS
Cutting Condition

END MILLS

END MILLS
Cutting Condition

TAPS

TAPS
Cutting Condition

Others

Technical Data

List No.9398 GS-MILL HARD



This end mill is most suitable for super-high-speed machining of hardened material by "GS Hard Coat".

(Unit) : mm

DRILLS

DRILLS Cutting Condition

Dia. of Mill	Shank Dia.	Length of Cut	No. of Flutes	Overall Length
1	6	3	4	50
1.5	6	4	4	50
2	6	6	4	50
3	6	8	6	50
4	6	11	6	50
5	6	13	6	50
6	6	13	6	50
8	8	19	6	60
10	10	22	6	70
12	12	26	6	75
16	16	32	8	90
20	20	38	8	100

END MILLS

Dia. of Mill (mm)		Tolerance (mm)
Above	Up to	
	3	0~-0.015
3		0~-0.030

1 per tube

END MILLS Cutting Condition

List No.9422



Suitable for high efficiency and high precision finishing of hardened die and mold.

(Unit) : mm

TAPS

TAPS Cutting Condition

Ball Radius	Dia. of Mill D	Shank Dia.	Length of Cut	L1	α	Overall Length
0.2	0.4	4	0.4	0.6	10°	50
0.3	0.6	4	0.6	0.9	10°	50
0.5	1	4	1	1.5	10°	50
0.75	1.5	4	1.5	2.3	10°	50
1	2	6	2	3	15°	60
1.25	2.5	6	2.5	3.8	15°	60
1.5	3	6	3	4.5	15°	60
2	4	6	4	6	15°	70
2.5	5	6	5	7.5	15°	80
3	6	6	6	—	—	80
4	8	8	8	—	—	90
5	10	10	10	—	—	100
6	12	12	12	—	—	110

Tolerance of Ball Radius : +0.003~-0.007mm

1 per tube

* JAPAN STOCK ITEM : Please allow 2-3 weeks delivery

Others

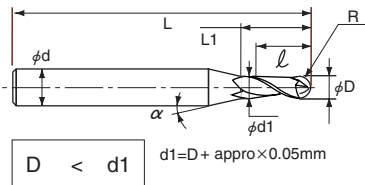

GEO-MILL HARD / INCH SIZES
GEO-MILL HARD BALL / INCH SIZES

List No.9399 GEO-MILL HARD



NEW

This end mill is most suitable for super-high-speed machining of hardened material by "GS Hard Coat".

EDP. NO	Dia. of Mill	Shank Dia.	Length of Cut	No. of Flutes	Overall Length
1386186	1/4"	1/4"	5/8"	6	2-1/2"
1386192	3/8"	3/8"	1"	8	3"
1386208	1/2"	1/2"	1-1/8"	8	3-1/2"
1386214	5/8"	5/8"	1-1/2"	10	4"
1386220	3/4"	3/4"	1-3/4"	10	4-1/4"

List No.9423 GEO-MILL HARD BALL



NEW

Suitable for high efficiency and high precision finishing of hardened die and mold.

EDP. NO	Ball Radius	Dia. of Mill D	Shank Dia.	Length of Cut	L1 (mm)	α	Overall Length
1386237	1/64"	1/32"	1/4"	3/64"	1.6	10°	3"
1386243	1/32"	1/16"	1/4"	3/32"	3.2	10°	3"
1386250	1/16"	1/8"	1/4"	3/16"	6.4	15°	3"
1386266	3/32"	3/16"	1/4"	9/32"	9.5	15°	3"
1386272	1/8"	1/4"	1/4"	3/8"	—	—	3"
1386289	5/32"	5/16"	5/16"	15/32"	—	—	3-3/16"
1386295	3/16"	3/8"	3/8"	9/16"	—	—	3-3/16"

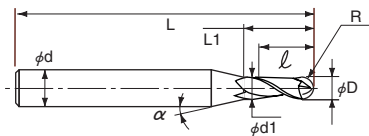

$D < d1$
 $d1 = D + \text{appro} \times 0.05\text{mm}$

Technical Data

DRILLS

DRILLS
Cutting Condition

END MILLS

END MILLS
Cutting Condition

TAPS

TAPS
Cutting Condition

Others

Technical Data

List No.9322



This end mill realizes feed speed of 80 IPM, and is adaptable in workpiece material from Carbon Steels and Mold Steels to Hard-to-cut materials.

(Unit) : mm

DRILLS

DRILLS Cutting Condition

END MILLS

END MILLS Cutting Condition

TAPS

TAPS Cutting Condition

Others

Dia. of Mill	Shank Dia.	Length of Cut	Overall Length
2	4	6	50
2.1	4	6	50
2.2	4	6	50
2.3	4	6	50
2.4	4	8	50
2.5	4	8	50
2.6	4	8	50
2.7	4	8	50
2.8	4	8	50
2.9	4	8	50
3	6	8	50
3.1	6	8	50
3.2	6	8	50
3.3	6	8	50
3.4	6	10	50
3.5	6	10	50
3.6	6	10	50
3.7	6	10	50
3.8	6	11	50
3.9	6	11	50
4	6	11	50
4.1	6	11	50
4.2	6	11	50
4.3	6	11	50
4.4	6	11	50
4.5	6	11	50
4.6	6	11	50
4.7	6	11	50
4.8	6	13	60
4.9	6	13	60
5	6	13	60
5.1	6	13	60
5.2	6	13	60
5.3	6	13	60
5.4	6	13	60
5.5	6	13	60
5.6	6	13	60

Dia. of Mill	Shank Dia.	Length of Cut	Overall Length
5.7	6	13	60
5.8	6	13	60
5.9	6	13	60
6	6	13	60
6.1	8	16	70
6.2	8	16	70
6.3	8	16	70
6.4	8	16	70
6.5	8	16	70
6.6	8	16	70
6.7	8	16	70
6.8	8	16	70
6.9	8	16	70
7	8	16	70
7.1	8	16	70
7.2	8	16	70
7.3	8	16	70
7.4	8	16	70
7.5	8	16	70
7.6	8	19	80
7.7	8	19	80
7.8	8	19	80
7.9	8	19	80
8	8	19	80
8.1	10	19	90
8.2	10	19	90
8.3	10	19	90
8.4	10	19	90
8.5	10	19	90
8.6	10	19	90
8.7	10	19	90
8.8	10	19	90
8.9	10	19	90
9	10	19	90
9.1	10	19	90
9.2	10	19	90
9.3	10	19	90

Dia. of Mill	Shank Dia.	Length of Cut	Overall Length
9.4	10	19	90
9.5	10	19	90
9.6	10	22	90
9.7	10	22	90
9.8	10	22	90
9.9	10	22	90
10	10	22	90
10.1	12	22	90
10.2	12	22	90
10.3	12	22	90
10.4	12	22	90
10.5	12	22	90
10.6	12	22	90
10.7	12	22	90
10.8	12	22	90
10.9	12	22	90
11	12	22	90
11.1	12	22	90
11.2	12	22	90
11.3	12	22	90
11.4	12	22	90
11.5	12	22	90
11.6	12	26	90
11.7	12	26	90
11.8	12	26	90
11.9	12	26	90
12	12	26	90
14	16	26	110
15	16	26	110
16	16	32	115
18	20	32	120
20	20	38	125
22	20	50	140
25	25	50	140
28	25	60	165
30	25	60	165
32	32	70	175

Dia. of Mill (mm)		Tolerance of Dia. (mm)
Above	Up to	
	3	-0.014~-0.028
3	6	-0.020~-0.038
6	10	-0.025~-0.047
10		-0.032~-0.059

1 per tube
* JAPAN STOCK ITEM : Please allow 2-3 weeks delivery

List No.9321



This end mill realizes feed speed of 80 IPM, and is adaptable in workpiece material from Carbon Steels and Mold Steels to Hard-to-cut materials.

L9321	Dia. of Mill	Shank Diameter	Length of Cut	No. of Flutes	Overall Length
GMS04	1/8	1/8	3/8	4	1-1/2
GMS06	3/16	3/16	5/8	4	2
GMS08	1/4	1/4	1/2	4	2-1/2
GMS10	5/16	5/16	13/16	4	2-1/2
GMS12	3/8	3/8	7/8	4	2-1/2
GMS14	7/16	7/16	1	4	2-3/4
GMS16	1/2	1/2	1	4	3
GMS20	5/8	5/8	1-1/4	4	3-1/2
GMS24	3/4	3/4	1-1/2	4	4
GMS32	1	1	1-1/2	4	4

1 per tube

Technical Data

DRILLS

DRILLS
Cutting Condition

END MILLS

END MILLS
Cutting Condition

TAPS

TAPS
Cutting Condition

Others

List No.9324

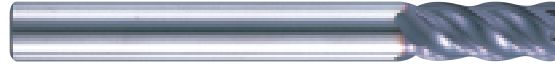

This end mill realizes feed speed of 80 IPM. This end mill having corner radius is used for corner radius milling.

(Unit) : mm

Dia. of Mill	Corner Radius	Shank Dia.	Length of Cut	Overall Length
3	0.2	6	8	50
3	0.5	6	8	50
4	0.2	6	11	50
4	0.5	6	11	50
4	1.0	6	11	50
5	0.2	6	13	60
5	0.5	6	13	60
5	1.0	6	13	60
6	0.3	6	13	60
6	0.5	6	13	60
6	1.0	6	13	60
6	1.5	6	13	60
8	0.3	8	19	80
8	0.5	8	19	80
8	1.0	8	19	80
8	1.5	8	19	80
8	2.0	8	19	80
10	0.3	10	22	90
10	0.5	10	22	90
10	1.0	10	22	90
10	1.5	10	22	90
10	2.0	10	22	90
12	0.5	12	26	90
12	1.0	12	26	90
12	1.5	12	26	90
12	2.0	12	26	90
12	3.0	12	26	90
16	1.0	16	32	115
16	1.5	16	32	115
16	2.0	16	32	115
16	3.0	16	32	115
20	1.0	20	38	125
20	1.5	20	38	125
20	2.0	20	38	125
20	3.0	20	38	125

Dia. of Mill (mm)		Tolerance (mm)	
Above	Up to	Dia. of Mill	Corner Radius
	3	-0.014~-0.028	+0.02~-0.01
3	6	-0.020~-0.038	
6	10	-0.025~-0.047	
10		-0.032~-0.059	

1 per tube

* JAPAN STOCK ITEM :
Please allow 2-3 weeks delivery

Technical
Data

DRILLS

DRILLS
Cutting Condition

END MILLS

END MILLS
Cutting Condition

TAPS

TAPS
Cutting Condition

Others

List No.9338



This end mill is available from plunging to slotting continuously and is used for workpiece materials from raw materials to hardened materials.

(Unit) : mm

Dia. of Mill	Shank Dia.	Length of Cut	Overall Length
1	4	3	50
1.5	4	4	50
2	4	6	50
2.5	4	8	50
3	6	8	50
3.5	6	10	50
4	6	11	50
4.5	6	11	50
5	6	13	60
5.5	6	13	60
6	6	13	60
6.5	8	16	70
7	8	16	70
7.5	8	16	70
8	8	19	80
8.5	10	19	90
9	10	19	90
9.5	10	19	90
10	10	22	90
11	12	22	90
12	12	26	90
13	12	26	100
14	16	26	110
15	16	26	110
16	16	32	115

Dia. of Mill (mm)		Tolerance of Dia. (mm)
Above	Up to	
	3	-0.014~-0.028
3	6	-0.020~-0.038
6	10	-0.025~-0.047
10		-0.032~-0.059

1 per tube

* JAPAN STOCK ITEM : Please allow 2-3 weeks delivery

Technical Data

DRILLS

DRILLS
Cutting Condition

END MILLS

END MILLS
Cutting Condition

TAPS

TAPS
Cutting Condition

Others

Technical Data

List No.9366 Two Flute



This end mill is the best in grooving of Fiber optics component, and controls less burr.

Length of Cut : 1.5xD

(Unit) : mm

Dia. of Mill D	Shank Dia.	Length of Cut	L1	Overall Length
0.5	3	0.75	1.2	38
1	3	1.5	2.5	38
1.2	3	1.8	2.8	38
1.5	3	2.25	3.2	38
2	3	3	4	38
2.5	3	3.75	4.7	38
3	3	4.5	—	38

1 per tube

Length of Cut : 2.5xD

(Unit) : mm

Dia. of Mill D	Shank Dia.	Length of Cut	L1	Overall Length
0.5	3	1.25	1.7	38
1	3	2.5	3.5	38
1.2	3	3	4	38
1.5	3	3.75	4.7	38
2	3	5	6	38
2.5	3	6.25	7.2	38
3	3	7.5	—	38

Tolerance of Diameter : 0~-0.015mm

1 per tube

* JAPAN STOCK ITEM : Please allow 2-3 weeks delivery

DRILLS

DRILLS Cutting Condition

END MILLS

END MILLS Cutting Condition

TAPS

TAPS Cutting Condition

Others

List No.9368 Four Flute



This end mill the best in side milling of Fiber optics component, and controls less burr.

Length of Cut : 1.5xD

(Unit) : mm

Dia. of Mill D	Shank Dia.	Length of Cut	L1	Overall Length
1	3	1.5	2.5	38
1.2	3	1.8	2.8	38
1.5	3	2.25	3.2	38
2	3	3	4	38
2.5	3	3.75	4.7	38
3	3	4.5	—	38

1 per tube

* JAPAN STOCK ITEM : Please allow 2-3 weeks delivery

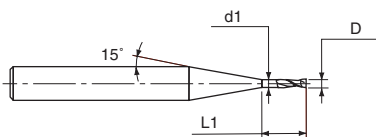

$D < d1$
 $d1 = D + 0.05\text{mm}$

List No.9340 X'S-MILL GEO BALL



This end mill is suitable for high efficiency and high precision finishing of molding dies, and is adaptable in workpiece material from Carbon Steels and Mold Die Steels to hardened materials.

(Unit) : mm

Ball Radius	Dia. of Mill	Shank Dia.	Length of Cut	L1	α	Overall Length
0.5	1	4	1.5	3	10°	50
0.75	1.5	4	2.5	4	10°	50
1	2	6	3	5	15°	60
1.25	2.5	6	4	6	15°	60
1.5	3	6	4.5	8	15°	80
2	4	6	6	12	15°	80
2.5	5	6	7.5	14	15°	90
3	6	6	9	—	—	100
3.5	7	8	11	20	20°	100
4	8	8	12	—	—	100
4.5	9	10	14	25	20°	120
5	10	10	15	—	—	120
5.5	11	12	17	30	20°	120
6	12	12	18	—	—	120
6.5	13	16	20	35	20°	160
7	14	16	21	38	—	160
7.5	15	16	23	40	20°	160
8	16	16	24	—	—	160
9	18	20	27	50	20°	180
10	20	20	30	—	—	180
12.5	25	25	38	—	—	200
15	30	32	45	80	20°	200

Ball Radius (mm)		Tolerance (mm)	
Above	Up to	Dia. of Mill	Ball Radius
	8	0~-0.030	±0.01
8		0~-0.040	

1 per tube
* JAPAN STOCK ITEM : Please allow 2-3 weeks delivery

Technical Data

DRILLS

DRILLS Cutting Condition

END MILLS

END MILLS Cutting Condition

TAPS

TAPS Cutting Condition

Others

List No.9332



This end mill is suitable for high precision and fine milling, and is adaptable in workpiece material from Carbon Steels and Mold Die Steels to hardened materials.

(Unit) : mm

Ball Radius	Dia. of Mill D	Shank Dia.	Length of Cut	L1	α	Overall Length
0.1	0.2	6	0.2	—	13.5°	50
0.15	0.3	6	0.3	—	13.5°	50
0.2	0.4	6	0.4	—	13.5°	50
0.25	0.5	6	0.5	1.5	15°	50
0.3	0.6	6	0.6	1.8	15°	50
0.4	0.8	6	0.8	2.4	15°	50
0.5	1.0	6	1	2.5	15°	50
0.6	1.2	6	1.2	3	15°	50
0.7	1.4	6	1.4	3.5	15°	50
0.75	1.5	6	1.5	3.8	15°	50
0.8	1.6	6	1.6	4	15°	50
0.9	1.8	6	1.8	4.5	15°	50
1	2.0	6	2	5	15°	50
1.25	2.5	6	2.5	5	13°	50
1.5	3.0	6	3	6	13°	50
1.75	3.5	6	3.5	6	10°	50
2	4.0	6	4	6	10°	50

1 per tube

* JAPAN STOCK ITEM : Please allow 2-3 weeks delivery

Ball Radius (mm)		Tolerance (mm)	
Above	Up to	Dia. of Mill	Ball Radius
	0.2	0~-0.015	0~+0.005
0.2	2.0		±0.010

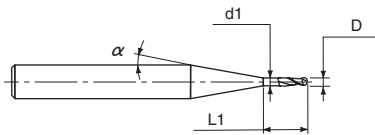

$$D > d1$$

$$d1 = D - \beta$$

($\beta = 0.015 - 0.06 \text{ mm}$)

Technical
Data

DRILLS

DRILLS
Cutting
Condition

END MILLS

END MILLS
Cutting
Condition

TAPS

TAPS
Cutting
Condition

Others

**DLC-MILL FOR ALUMINUM / METRIC SIZES
DLC-MILL SHARP CORNER TWO FLUTE**

**USA & JAPAN
STOCK ITEM***

List No.9330 DLC-MILL FOR ALUMINUM / METRIC SIZES



**USA
STOCK ITEM**

This is suitable for Dry-milling of Aluminum with DLC coat.
(Unit) : mm

Dia. of Mill	Shank Dia.	Length of Cut	Overall Length
1	4	3	40
1.5	4	4	40
2	4	6	40
2.5	4	8	40
3	6	8	45
3.5	6	10	45
4	6	11	45
4.5	6	11	50
5	6	13	50
5.5	6	13	50
6	6	13	50
7	8	16	60
8	8	19	60
9	10	19	70
10	10	22	70
11	12	22	75
12	12	26	75
16	16	32	90
20	20	38	100

Tolerance of Dia. is same as List No.9378

1 per tube

List No.9378 DLC-MILL SHARP CORNER TWO FLUTE



**JAPAN
STOCK ITEM***

This end mill having sharp edge corner is suitable for excellent cutting surface of Aluminum.

(Unit) : mm

Dia. of Mill	Shank Dia.	Length of Cut	Overall Length
1	4	3	40
1.5	4	4	40
2	4	6	40
2.5	4	8	40
3	6	8	45
3.5	6	10	45
4	6	11	45
4.5	6	11	50
5	6	13	50
6	6	13	50
7	8	16	60
8	8	19	60
9	10	19	70
10	10	22	70
11	12	22	75
12	12	26	75
16	16	32	90
20	20	38	100

1 per tube

* JAPAN STOCK ITEM : Please allow 2-3 weeks delivery

Dia. of Mill (mm)		Tolerance of Dia. (mm)
Above	Up to	
	3	-0.014~-0.028
3	6	-0.020~-0.038
6	10	-0.025~-0.047
10		-0.032~-0.059

Technical Data

DRILLS

DRILLS
Cutting Condition

END MILLS

END MILLS
Cutting Condition

TAPS

TAPS
Cutting Condition

Others

List No.9302



This end mill is suitable for used for corner radius milling or copying of Aluminum.

(Unit) : mm

Dia. of Mill	Conner Radius	Shank Dia.	Length of Cut	Overall Length
2	0.2	4	6	40
3	0.2	6	8	45
3	0.5	6	8	45
4	0.2	6	11	45
4	0.5	6	11	45
5	0.2	6	13	50
5	0.5	6	13	50
6	0.3	6	13	50
6	0.5	6	13	50
6	1.0	6	13	50
7	0.3	8	16	60
7	0.5	8	16	60
7	1.0	8	16	60
8	0.3	8	19	60
8	0.5	8	19	60
8	1.0	8	19	60
10	0.3	10	22	70
10	0.5	10	22	70
10	1.0	10	22	70
12	0.5	12	26	75
12	1.0	12	26	75
12	2.0	12	26	75
16	0.5	16	32	90
16	1.0	16	32	90
16	2.0	16	32	90
16	3.0	16	32	90
20	0.5	20	38	100
20	1.0	20	38	100
20	2.0	20	38	100
20	3.0	20	38	100

Dia. of Mill (mm)		Tolerance of Dia. (mm)
Above	Up to	
	3	-0.014~-0.028
3	6	-0.020~-0.038
6	10	-0.025~-0.047
10		-0.032~-0.059

1 per tube
* JAPAN STOCK ITEM : Please allow 2-3 weeks delivery

Corner radius	Tolerance (mm)
0.2	+0.015~0
0.3	
0.5	+0.020~0
1.0	+0.030~0
2.0	+0.050~0
3.0	

Technical Data

DRILLS

DRILLS
Cutting Condition

END MILLS

END MILLS
Cutting Condition

TAPS

TAPS
Cutting Condition

Others

HIGH PERFORMANCE END MILLS

DLC-MILL SLOT LONG SHANK

JAPAN STOCK ITEM*

List No.9390



This end mill is for slotting and deep pocket milling in Aluminum Alloys.

(Unit) : mm

Dia. of Mill D	Shank Dia.	Length of Cut	L1	d1	Overall Length
2	4	3	8	1.9	50
3	6	4.5	12	2.9	60
4	6	6	16	3.8	60
5	6	7.5	20	4.8	60
6	6	9	24	5.8	60
7	6	10.5	—	—	80
8	8	12	34	7.7	80
9	8	13.5	—	—	90
10	10	15	42	9.7	100
11	10	16.5	—	—	120
12	12	18	50	11.7	120
13	12	19.5	—	—	130
16	16	24	66	15.5	160
17	16	25.5	—	—	170
20	20	30	82	19.5	200

Dia. of Mill (mm)		Tolerance of Dia. (mm)
Above	Up to	
	3	-0.014~-0.028
3	6	-0.020~-0.038
6	10	-0.025~-0.047
10		-0.032~-0.059

1 per tube
* JAPAN STOCK ITEM : Please allow 2-3 weeks delivery

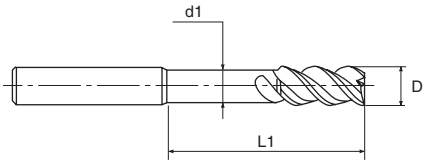

Technical Data

DRILLS

DRILLS
Cutting Condition

END MILLS

END MILLS
Cutting Condition

TAPS

TAPS
Cutting Condition

Others

List No.9360



This end mill is used in profile milling of Aluminum.

(Unit) : mm

Ball Radius	Dia. of Mill	Shank Dia.	Length of Cut	Overall Length
0.5	1	4	1.5	50
0.75	1.5	4	2.5	50
1	2	6	3	60
1.25	2.5	6	4	60
1.5	3	6	4.5	80
2	4	6	6	80
2.5	5	6	7.5	90
3	6	6	9	100
3.5	7	8	11	100
4	8	8	12	100
4.5	9	10	14	120
5	10	10	15	120
5.5	11	12	17	120
6	12	12	18	120
6.5	13	16	20	160
7	14	16	21	160
7.5	15	16	23	160
8	16	16	24	160
9	18	20	27	180
10	20	20	30	180

Ball Radius (mm)		Tolerance (mm)	
Above	Up to	Dia. of Mill	Ball Radius
	8	0~-0.030	+0.010
8		0~-0.040	

1 per tube
* JAPAN STOCK ITEM : Please allow 2-3 weeks delivery

Technical
Data

DRILLS

DRILLS
Cutting
Condition

END MILLS

END MILLS
Cutting
Condition

TAPS

TAPS
Cutting
Condition

Others

List No.6450 DLC-HSS MILL / METRIC SIZES



JAPAN
STOCK ITEM*

This end mill is suitable for grooving of Aluminums.
(Unit) : mm

Dia. of Mill	Shank Dia.	Length of Cut	Overall Length
1	6	2	50
1.5	6	3	50
2	6	4	50
2.5	6	5	50
3	6	6	50
3.5	8	8	60
4	8	8	60
4.5	8	10	60
5	8	10	60
5.5	8	12	60
6	8	12	60
6.5	10	14	65
7	10	14	65
7.5	10	14	65
8	10	14	65
8.5	10	18	70
9	10	18	70
9.5	10	18	70
10	10	18	70
11	12	22	80
12	12	22	80
13	16	26	90
14	16	26	90
15	16	30	95
16	16	30	95
17	20	35	105
18	20	35	105
19	20	40	110
20	20	40	110

Dia. of Mill (mm)		Tolerance of Dia. (mm)
Above	Up to	
	10	0~-0.020
10		0~-0.025

1 per tube
* JAPAN STOCK ITEM : Please allow 2-3 weeks delivery

List No.6231HD DLC-HSS MILL / INCH SIZES



USA
STOCK ITEM

This end mill is suitable for grooving of Aluminums.

L6231HD	Dia. of Mill	Shank Diameter	Length of Cut	No. of Flutes	Overall Length
PGHDL4	1/8	3/8	3/8	2	2-5/16
PGHDL6	3/16	3/8	7/16	2	2-5/16
PGHDL8	1/4	3/8	5/8	2	2-7/16
PGHDL10	5/16	3/8	3/4	2	2-1/2
PGHDL12	3/8	3/8	3/4	2	2-1/2
PGHDL14	7/16	3/8	1	2	2-11/16
PGHDL16	1/2	1/2	1-1/4	2	3-1/4
PGHDL20	5/8	5/8	1-5/8	2	3-3/4
PGHDL24	3/4	3/4	1-5/8	2	4-1/8
PGHDL32	1	1	2	2	4-1/2

1 per tube

Technical Data

DRILLS

DRILLS
Cutting Condition

END MILLS

END MILLS
Cutting Condition

TAPS

TAPS
Cutting Condition

Others

AG-MILL ROUGHING/INCH SIZES

AG-MILL HEAVY/INCH SIZES

Technical
Data

DRILLS

DRILLS
Cutting Condition

END MILLS

END MILLS
Cutting Condition

TAPS

TAPS
Cutting Condition

Others

List No.6485 ROUGHING/INCH SIZES



This end mill is most suitable for high-speed rough milling, fine pitch nick is used.

L6485	Dia. of Mill	Shank Diameter	Length of Cut	No. of Flutes	Overall Length
PQFAG8-2	1/4	3/8	5/8	4	2-7/16
PQFAG10-2	5/16	3/8	3/4	4	2-1/2
PQFAG12-2	3/8	3/8	3/4	4	2-1/2
PQFAG16-3	1/2	1/2	1-1/4	4	3-1/4
PQFAG20-4	5/8	5/8	1-5/8	4	3-3/4
PQFAG24-5	3/4	3/4	1-5/8	4	3-7/8
PQFAG28-6	7/8	7/8	1-7/8	5	4-1/8
PQFAG32-7	1	1	2	5	4-1/2
PQFAG40-8	1-1/4	1-1/4	2	6	4-1/2
PQFAG48-8	1-1/2	1-1/4	2	6	4-1/2
PQFAG64-8	2	1-1/4	2	8	4-1/2

1 per tube

List No.6403 HEAVY/INCH SIZES



This end mill is suitable for high-speed rough milling and semi-finish milling.

L6403	Dia. of Mill	Shank Diameter	Length of Cut	No. of Flutes	Overall Length
PKAG8-2	1/4	3/8	5/8	4	2-7/16
PKAG10-2	5/16	3/8	3/4	4	2-1/2
PKAG12-2	3/8	3/8	3/4	4	2-1/2
PKAG16-3	1/2	1/2	1-1/4	4	3-1/4
PKAG20-4	5/8	5/8	1-5/8	4	3-3/4
PKAG24-5	3/4	3/4	1-5/8	4	3-7/8
PKAG28-6	7/8	7/8	1-7/8	4	4-1/8
PKAG32-7	1	1	2	6	4-1/2
PKAG40-8	1-1/4	1-1/4	2	6	4-1/2
PKAG48-8	1-1/2	1-1/4	2	6	4-1/2
PKAG64-8	2	1-1/4	2	8	4-1/2

1 per tube

AG-MILL ROUGHING SHORT AG-MILL ROUGHING REGULAR LENGTH SHORT

JAPAN
STOCK ITEM*

List No.6406 SHORT

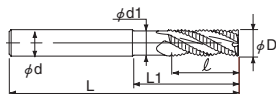

This end mill is suitable for high-feed rough milling, fine pitch nick is used.

(Unit) : mm

Dia. of Mill D	Shank Dia. d	Length of Cut l	L1	d1	No. of Flutes	Overall Length L
6	6	11	—	—	4	80
7	8	17	—	—	4	90
8	8	17	—	—	4	90
9	10	22	—	—	4	100
10	10	22	—	—	4	100
11	12	26	—	—	4	110
12	12	26	—	—	4	110
14	12	26	—	—	4	110
15	16	26	45	13.3	4	125
16	16	32	48	14.3	4	125
18	16	32	—	—	4	125
20	20	38	60	18	4	140
22	20	38	—	—	4	140
24	20	45	—	—	5	160
25	25	45	75	23	5	160
28	25	45	—	—	5	160
30	25	45	—	—	5	160
32	32	53	95	29.5	6	180
35	32	53	—	—	6	180
40	32	63	—	—	6	200
45	42	63	—	—	6	200
50	42	75	—	—	6	220

Tolerance of Diameter : ±0.1mm

1 per tube

* JAPAN STOCK ITEM : Please allow 2-3 weeks delivery

List No.6484 REGULAR LENGTH SHORT



This end mill is most suitable for high-speed rough milling, fine pitch nick is used.

(Unit) : mm

Dia. of Mill D	Shank Dia.	Length of Cut	No. of Flutes	Overall Length
6	6	15	4	60
7	10	20	4	65
8	10	20	4	65
9	10	25	4	75
10	10	25	4	75
11	12	30	4	80
12	12	30	4	80
14	16	35	4	90
15	16	35	4	90
16	16	40	4	95
18	20	40	4	105
20	20	45	4	110
22	20	45	4	110
24	25	50	5	120
25	25	50	5	120
28	25	55	5	125
30	32	55	5	140
32	32	60	6	145
35	32	60	6	145
40	32	65	6	150
45	42	70	6	155
50	42	70	6	160

Tolerance of Diameter : ±0.1mm

1 per tube

* JAPAN STOCK ITEM : Please allow 2-3 weeks delivery

Technical Data

DRILLS

DRILLS
Cutting Condition

END MILLS

END MILLS
Cutting Condition

TAPS

TAPS
Cutting Condition

Others

AG-MILL ROUGHING MEDIUM
AG-MILL ROUGHING LONG

JAPAN STOCK ITEM*

Technical Data

List No.6486 MEDIUM

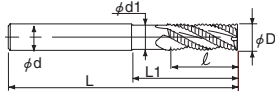

This end mill is most suitable for high-speed rough milling, fine pitch nick is used.

(Unit) : mm

Dia. of Mill D	Shank Dia. d	Length of Cut l	L1	d1	No. of Flutes	Overall Length L
6	6	16	—	—	4	80
8	8	25	—	—	4	90
10	10	32	—	—	4	100
12	12	40	—	—	4	110
14	12	40	—	—	4	110
15	16	40	53	13.3	4	125
16	16	48	56	14.3	4	125
18	16	48	—	—	4	125
20	20	56	70	18.0	4	140
22	20	56	—	—	4	140
24	20	67	—	—	5	160
25	25	67	88	23.0	5	160
28	25	67	—	—	5	160
30	25	67	—	—	5	160
32	32	80	112	29.5	6	180
35	32	80	—	—	6	180
40	32	95	—	—	6	200
45	42	95	—	—	6	200
50	42	112	—	—	6	220

Tolerance of Diameter : ±0.1mm

1 per tube

* JAPAN STOCK ITEM : Please allow 2-3 weeks delivery

DRILLS

DRILLS
Cutting Condition

END MILLS

END MILLS
Cutting Condition

TAPS

TAPS
Cutting Condition

Others

List No.6488 LONG



This end mill is most suitable for high-speed rough milling, fine pitch nick is used.

(Unit) : mm

Dia. of Mill D	Shank Dia.	Length of Cut	No. of Flutes	Overall Length
6	6	26	4	80
8	8	35	4	90
10	10	45	4	100
12	12	53	4	110
14	12	53	4	110
15	16	53	4	125
16	16	63	4	125
18	16	63	4	125
20	20	75	4	140
22	20	75	4	140
24	20	90	5	160
25	25	90	5	160
28	25	90	5	160
30	25	90	5	160
32	32	106	6	180
35	32	106	6	180
40	32	125	6	200
45	42	125	6	230
50	42	150	6	250

Tolerance of Diameter : ±0.1mm

1 per tube

* JAPAN STOCK ITEM : Please allow 2-3 weeks delivery

List No.6402



This end mill is suitable for high-speed rough milling and semi-finish milling.

(Unit) : mm

Dia. of Mill D	Shank Dia.	Length of Cut	No. of Flutes	Overall Length
3	6	9	4	50
4	8	12	4	60
5	8	15	4	60
6	8	15	4	60
7	10	20	4	65
8	10	20	4	65
9	12	25	4	75
10	12	25	4	75
11	12	30	4	80
12	12	30	4	80
13	16	35	4	90
14	16	35	4	90
15	16	40	4	95
16	16	40	4	95
17	20	40	4	105
18	20	40	4	105
19	20	45	4	110
20	20	45	4	110
21	20	45	4	110
22	20	45	4	110
23	25	50	4	120
24	25	50	4	120
25	25	50	4	120
26	25	50	4	120
27	25	55	4	125
28	25	55	6	125
29	25	55	6	125
30	25	55	6	125
32	32	60	6	145
35	32	60	6	145
40	32	65	6	150
45	32	70	6	160
45	42	70	6	160
50	32	70	6	160
50	42	70	6	160

Dia. of Mill (mm)		Tolerance of Dia. (mm)
Above	Up to	
	3	+0.025~0
3	6	+0.030~0
6	10	+0.036~0
10	18	+0.043~0
18	30	+0.052~0
30		+0.062~0

1 per tube
* JAPAN STOCK ITEM : Please allow 2-3 weeks delivery

Technical Data

DRILLS

DRILLS
Cutting Condition

END MILLS

END MILLS
Cutting Condition

TAPS

TAPS
Cutting Condition

Others

List No.6404



This end mill is suitable for high-speed rough milling and semi-finish milling.

(Unit) : mm

Dia. of Mill D	Shank Dia.	Length of Cut	No. of Flutes	Overall Length
3	6	15	4	60
4	8	20	4	60
5	8	25	4	65
6	8	25	4	65
7	10	35	4	80
8	10	35	4	80
9	12	45	4	95
10	12	45	4	95
11	12	55	4	105
12	12	55	4	105
13	16	55	4	110
14	16	55	4	110
15	16	65	4	120
16	16	65	4	120
17	20	65	4	130
18	20	65	4	130
19	20	75	4	140
20	20	75	4	140
22	20	75	4	140
25	25	90	4	160
28	25	90	6	160
30	25	90	6	160
32	32	105	6	190
35	32	105	6	190
40	32	125	6	210
45	32	145	6	230
45	42	145	6	230
50	32	145	6	230
50	42	145	6	230

1 per tube

* JAPAN STOCK ITEM : Please allow 2-3 weeks delivery

Technical
Data

DRILLS

DRILLS
Cutting Condition

END MILLS

END MILLS
Cutting Condition

TAPS

TAPS
Cutting Condition

Others

List No.9261X Regular



Two Flute, Single End

SG COATED CARBIDE



List No.9271X Ball Nose



Two Flute, Ball Nose

SG COATED CARBIDE



L9261X	L9271X	Diameter of Mill	Shank Diameter	Length of Cut	Number of Flutes	Overall Length
CGX4	CRGX4	1/8	1/8	1/2	2	1 1/2
CGX6	CRGX6	3/16	3/16	5/8	2	2
CGX8	CRGX8	1/4	1/4	3/4	2	2 1/2
CGX10	CRGX10	5/16	5/16	13/16	2	2 1/2
CGX12	CRGX12	3/8	3/8	1	2	2 1/2
CGX14	CRGX14	7/16	7/16	1	2	2 3/4
CGX16	CRGX16	1/2	1/2	1	2	3
CGX20	CRGX20	5/8	5/8	1 1/4	2	3 1/2
CGX24	CRGX24	3/4	3/4	1 1/2	2	4
CGX32	CRGX32	1	1	1 1/2	2	4

1 per tube

List No.9263X Regular



Four Flute, Single End

SG COATED CARBIDE

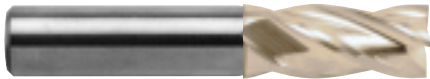

List No.9273X Ball Nose



Four Flute, Ball Nose

SG COATED CARBIDE



L9263X	L9273X	Diameter of Mill	Shank Diameter	Length of Cut	Number of Flutes	Overall Length
CFX4	CRFX4	1/8	1/8	1/2	4	1 1/2
CFX6	CRFX6	3/16	3/16	5/8	4	2
CFX8	CRFX8	1/4	1/4	3/4	4	2 1/2
CFX10	CRFX10	5/16	5/16	13/16	4	2 1/2
CFX12	CRFX12	3/8	3/8	1	4	2 1/2
CFX14	CRFX14	7/16	7/16	1	4	2 3/4
CFX16	CRFX16	1/2	1/2	1	4	3
CFX20	CRFX20	5/8	5/8	1 1/4	4	3 1/2
CFX24	CRFX24	3/4	3/4	1 1/2	4	4
CFX32	CRFX32	1	1	1 1/2	4	4

1 per tube

Technical Data

DRILLS

DRILLS
Cutting Condition

END MILLS

END MILLS
Cutting Condition

TAPS

TAPS
Cutting Condition

Others

GENAC END MILLS "SG" COATED CARBIDE

Technical Data

* List No.9221X



High Helix 3 Flute 60 Degree

SG COATED CARBIDE



DRILLS

DRILLS Cutting Condition

L9221X	Dia. of Mill	Shank Dia.	Length of Cut	Number of Flutes	Overall Length
CHHX4	1/8	1/8	3/8	3	1 1/2
CHHX6	3/16	3/16	5/8	3	2
CHHX8	1/4	1/4	3/4	3	2 1/2
CHHX10	5/16	5/16	13/16	3	2 1/2
CHHX12	3/8	3/8	7/8	3	2 1/2
CHHX14	7/16	7/16	7/8	3	2 1/2
CHHX16	1/2	1/2	1	3	3
CHHX20	5/8	5/8	1 1/4	3	3 1/2
CHHX24	3/4	3/4	1 1/2	3	4
CHHX32	1	1	1 1/2	3	4

* item will be discontinued, after stock has depleted.
We recommend L9321 GEO fractional as substitution item for L9221X.

1 per tube

END MILLS

END MILLS Cutting Condition

List No.9251X



Roughing Center Cutting

SG COATED CARBIDE



TAPS

TAPS Cutting Condition

L9251X	Dia. of Mill	Shank Dia.	Length of Cut	Number of Flutes	Overall Length
CQX8	1/4	1/4	3/4	4	2 1/2
CQX12	3/8	3/8	7/8	4	2 1/2
CQX16	1/2	1/2	1	4	3
CQX16-1	1/2	1/2	2	4	4
CQX20	5/8	5/8	1 1/4	5	3 1/2
CQX20-1	5/8	5/8	2 1/2	5	5
CQX24	3/4	3/4	1 1/2	6	4
CQX24-1	3/4	3/4	3	6	6
* CQX32	1	1	2	6	4
* CQX32-1	1	1	3	6	6
* CQX40	1 1/4	1 1/4	3	6	6

* item will be discontinued, after stock has depleted.

1 per tube

Others

*** List No.9265X**



Two Flute
Long, Single End

SG COATED CARBIDE



List No.9267X



Four Flute
Long, Single End

SG COATED CARBIDE



L9265X	L9267X	Dia. of Mill	Shank Dia.	Length of Cut	Overall Length
CGLX4	CFLX4	1/8	1/8	3/4	2 1/4
CGLX6	CFLX6	3/16	3/16	3/4	2 1/2
CGLX8	CFLX8	1/4	1/4	1 1/8	3
CGLX10	CFLX10	5/16	5/16	1 1/8	3
CGLX12	CFLX12	3/8	3/8	1 1/8	3
CGLX14	CFLX14	7/16	7/16	2	4 1/2
CGLX16	CFLX16	1/2	1/2	2	4 1/2
CGLX20	CFLX20	5/8	5/8	2 1/4	5
CGLX24	CFLX24	3/4	3/4	2 1/4	5
CGLX32	CFLX32	1	1	2 1/4	5

* item will be discontinued, after stock has depleted.

We recommend L9267X Genac End Mill Four Flute long as substitution item for L9265X.

1 per tube

*** List No.9275X**



Two Flute, Ball Nose
Long, Single End

SG COATED CARBIDE



*** List No.9277X**



Four Flute, Ball Nose
Long, Single End

SG COATED CARBIDE



L9275X	L9277X	Dia. of Mill	Shank Dia.	Length of Cut	Overall Length
CRGLX4	CRFLX4	1/8	1/8	3/4	2 1/4
CRGLX6	CRFLX6	3/16	3/16	3/4	2 1/2
CRGLX8	CRFLX8	1/4	1/4	1 1/8	3
CRGLX10	CRFLX10	5/16	5/16	1 1/8	3
CRGLX12	CRFLX12	3/8	3/8	1 1/8	3
CRGLX14	CRFLX14	7/16	7/16	2	4 1/2
CRGLX16	CRFLX16	1/2	1/2	2	4 1/2
CRGLX20	CRFLX20	5/8	5/8	2 1/4	5
CRGLX24	CRFLX24	3/4	3/4	2 1/4	5
CRGLX32	CRFLX32	1	1	2 1/4	5

* item will be discontinued, after stock has depleted.

We recommend L9340 Geo ball (Metric size) as substitution item for L9275X.

We recommend L9340 Geo ball (Metric size) as substitution item for L9277X.

1 per tube

Technical Data

DRILLS

DRILLS
Cutting Condition

END MILLS

END MILLS
Cutting Condition

TAPS

TAPS
Cutting Condition

Others

List No.6367



Surface Treat

8% COBALT HSS



List No.6367X



8% COBALT "SG" COATED



L6367	L6367X	Diameter of Mill	Shank Diameter	Length of Cut	Number of Flutes	Overall Length
PK8-2	PKX8-2	1/4	3/8	5/8	4	2 7/16
PK10-2	PKX10-2	5/16	3/8	3/4	4	2 1/2
PK12-2	PKX12-2	3/8	3/8	3/4	4	2 1/2
PK16-3	PKX16-3	1/2	1/2	1 1/4	4	3 1/4
PK16-3A		1/2	1/2	2	4	4
PK20-4	PKX20-4	5/8	5/8	1 5/8	4	3 3/4
PK20-4A		5/8	5/8	2 1/2	4	4 5/8
PK24-4		3/4	5/8	1 5/8	4	3 3/4
PK24-5	PKX24-5	3/4	3/4	1 5/8	4	3 7/8
PK24-5A		3/4	3/4	3	4	5 1/4
PK28-5		7/8	3/4	1 7/8	4	4 1/8
PK28-6	PKX28-6	7/8	7/8	1 7/8	4	4 1/8
PK28-6A		7/8	7/8	3 1/2	4	5 3/4
PK32-5	PKX32-5	1	3/4	2	6	4 1/2
PK32-7	PKX32-7	1	1	2	6	4 1/2
PK32-7A	PKX32-7A	1	1	4	6	6 1/2
PK36-7		1 1/8	1	2	6	4 1/2
PK40-5		1 1/4	3/4	2	6	4 1/2
PK40-5A		1 1/4	3/4	4	6	6 1/2
PK40-8	PKX40-8	1 1/4	1 1/4	2	6	4 1/2
PK40-8A	PKX40-8A	1 1/4	1 1/4	4	6	6 1/2
PK48-5		1 1/2	3/4	2	6	4 1/2
PK48-5A		1 1/2	3/4	4	6	6 1/2
PK48-8	PKX48-8	1 1/2	1 1/4	2	6	4 1/2
PK48-8A	PKX48-8A	1 1/2	1 1/4	4	6	6 1/2
PK56-8	PKX56-8	1 3/4	1 1/4	2	6	4 1/2
PK56-8A		1 3/4	1 1/4	4	6	6 1/2
PK64-8	PKX64-8	2	1 1/4	2	8	4 1/2
PK64-8A		2	1 1/4	4	8	6 1/2
PK64-11	PKX64-11	2	2	4	8	7 3/4
PK64-11A		2	2	6	8	9 3/4
PK64-11B		2	2	8	8	11 3/4
PK80-11		2 1/2	2	4	8	7 3/4
PK80-11A		2 1/2	2	6	8	9 3/4
PK80-11B		2 1/2	2	8	8	11 3/4
PK80-11C		2 1/2	2	10	8	13 3/4
PK96-12		3	2 1/2	4	10	7 3/4
PK96-12A		3	2 1/2	6	10	9 3/4
PK96-12B		3	2 1/2	8	10	11 3/4
PK96-12C		3	2 1/2	10	10	13 3/4
PK96-12D		3	2 1/2	12	10	15 3/4

Shanks 2" And Larger Have Combination Drive
8 And 10 Flutes Are Not Center Cutting

1 per tube

ROUGHING (HOG) END MILLS

List No.6303



Bright Finish

8% COBALT HSS



List No.6303X



8% COBALT "SG" COATED



L6303	L6303X	Diameter of Mill	Shank Diameter	Length of Cut	Number of Flutes	Overall Length
PQ8-2	PQX8-2	1/4	3/8	5/8	4	2 7/16
PQ8-2A		1/4	3/8	1 1/4	4	3 1/16
PQ10-2	PQX10-2	5/16	3/8	3/4	4	2 1/2
PQ10-2A		5/16	3/8	1 3/8	4	3 1/8
PQ12-2	PQX12-2	3/8	3/8	3/4	4	2 1/2
PQ12-2A		3/8	3/8	1 1/2	4	3 1/4
PQ16-3	PQX16-3	1/2	1/2	1 1/4	4	3 1/4
PQ16-3A	PQX16-3A	1/2	1/2	2	4	4
PQ20-4	PQX20-4	5/8	5/8	1 5/8	4	3 3/4
PQ20-4A	PQX20-4A	5/8	5/8	2 1/2	4	4 5/8
PQ24-4		3/4	5/8	1 5/8	4	3 7/8
PQ24-4A		3/4	5/8	3	4	5 1/4
PQ24-5	PQX24-5	3/4	3/4	1 5/8	4	3 7/8
PQ24-5A	PQX24-5A	3/4	3/4	3	4	5 1/4
PQ28-5	PQX28-5	7/8	3/4	1 7/8	5	4 1/8
PQ28-5A		7/8	3/4	3 1/2	5	5 3/4
PQ28-6	PQX28-6	7/8	7/8	1 7/8	5	4 1/8
PQ28-6A		7/8	7/8	3 1/2	5	5 3/4
PQ32-5	PQX32-5	1	3/4	2	5	4 1/4
PQ32-5A		1	3/4	1	5	3 1/4
PQ32-7	PQX32-7	1	1	2	5	4 1/2
PQ32-7A	PQX32-7A	1	1	4	5	6 1/2
PQ32-7B	PQX32-7B	1	1	3	5	5 1/2
PQ36-7		1 1/8	1	2	5	4 1/2
PQ40-5		1 1/4	3/4	2	6	4 1/2
PQ40-5A		1 1/4	3/4	4	6	6 1/2
PQ40-8	PQX40-8	1 1/4	1 1/4	2	6	4 1/2
PQ40-8A	PQX40-8A	1 1/4	1 1/4	4	6	6 1/2
PQ40-8B	PQX40-8B	1 1/4	1 1/4	3	6	5 1/2
PQ48-5		1 1/2	3/4	2	6	4 1/2
PQ48-5A		1 1/2	3/4	4	6	6 1/2
PQ48-8	PQX48-8	1 1/2	1 1/4	2	6	4 1/2
PQ48-8A	PQX48-8A	1 1/2	1 1/4	4	6	6 1/2
PQ48-8B	PQX48-8B	1 1/2	1 1/4	3	6	5 1/2
PQ56-5		1 3/4	3/4	2	6	4 1/2
PQ56-5A		1 3/4	3/4	4	6	6 1/2
PQ56-8	PQX56-8	1 3/4	1 1/4	2	6	4 1/2
PQ56-8A	PQX56-8A	1 3/4	1 1/4	4	6	6 1/2
PQ56-8B	PQX56-8B	1 3/4	1 1/4	3	6	5 1/2
PQ64-8	PQX64-8	2	1 1/4	2	8	4 1/2
PQ64-8A		2	1 1/4	4	8	6 1/2
PQ64-8B		2	1 1/4	3	8	5 1/2
PQ64-11	PQX64-11	2	2	4	8	7 3/4
PQ64-11A	PQX64-11A	2	2	6	8	9 3/4
PQ64-11B		2	2	8	8	11 3/4
PQ64-11C	PQX64-11C	2	2	3	8	6 3/4

Shanks 2" And Larger Have Combination Drive
All Sizes Are Not Center Cutting

1 per tube

Technical Data

DRILLS

DRILLS
Cutting Condition

END MILLS

END MILLS
Cutting Condition

TAPS

TAPS
Cutting Condition

Others

List No.6307

8% COBALT HIGH SPEED STEEL



Fine Pitch Multi Flute
Non-Center Cutting



L.6307	Dia. of Mill	Shank Diameter	Length of Cut	Number of Flutes	Overall Length
PQF8-2	1/4	3/8	5/8	3	2 7/16
PQF8-2A	1/4	3/8	1 1/4	3	3 1/16
PQF10-2	5/16	3/8	3/4	3	2 1/2
PQF10-2A	5/16	3/8	1 3/8	3	3 1/8
PQF12-2	3/8	3/8	3/4	3	2 1/2
PQF12-2A	3/8	3/8	1 1/2	3	3 1/4
PQF16-3	1/2	1/2	1 1/4	4	3 1/4
PQF16-3A	1/2	1/2	2	4	4
PQF20-4	5/8	5/8	1 5/8	4	3 3/4
PQF20-4A	5/8	5/8	2 1/2	4	4 5/8
PQF24-4	3/4	5/8	1 5/8	4	3 7/8
PQF24-5	3/4	3/4	1 5/8	4	3 7/8
PQF28-5	7/8	3/4	1 7/8	5	4 1/8
PQF28-6	7/8	7/8	1 7/8	5	4 1/8
PQF32-5	1	3/4	2	5	4 1/4
PQF32-7	1	1	2	5	4 1/2
PQF32-7A	1	1	4	5	6 1/2
PQF32-7B	1	1	3	5	5 1/2
PQF36-7	1 1/8	1	2	5	4 1/2
PQF40-8	1 1/4	1 1/4	2	6	4 1/2
PQF40-8A	1 1/4	1 1/4	4	6	6 1/2
PQF40-8B	1 1/4	1 1/4	3	6	5 1/2
PQF48-8	1 1/2	1 1/4	2	6	4 1/2
PQF48-8A	1 1/2	1 1/4	4	6	6 1/2
PQF48-8B	1 1/2	1 1/4	3	6	5 1/2
PQF56-8	1 3/4	1 1/4	2	6	4 1/2
PQF64-8	2	1 1/4	2	6	4 1/2
PQF64-8A	2	1 1/4	4	6	6 1/2
PQF64-11	2	2	4	6	7 3/4
PQF64-11A	2	2	6	6	9 3/4

Shanks 2" And Larger Have Combination Drive

1 per tube

Technical Data

DRILLS

DRILLS
Cutting Condition

END MILLS

END MILLS
Cutting Condition

TAPS

TAPS
Cutting Condition

Others

* List No.231



HIGH SPEED STEEL



List No.6231



8% COBALT HIGH SPEED STEEL



List No.6231X



8% COBALT HIGH SPEED STEEL
SG COATED



L231	L6231	L6231X	Dia. of Mill	Shank Diameter	Length of Cut	Overall Length
G4	PG4	PGX4	1/8	3/8	3/8	2 5/16
G5	PG5		5/32	3/8	3/8	2 5/16
G6	PG6	PGX6	3/16	3/8	7/16	2 5/16
G7	PG7		7/32	3/8	7/16	2 5/16
G8	PG8	PGX8	1/4	3/8	1/2	2 5/16
G9	PG9		9/32	3/8	1/2	2 5/16
G10	PG10	PGX10	5/16	3/8	9/16	2 5/16
G11	PG11		11/32	3/8	9/16	2 5/16
G12	PG12	PGX12	3/8	3/8	9/16	2 5/16
G13	PG13		13/32	3/8	13/16	2 1/2
G14	PG14	PGX14	7/16	3/8	13/16	2 1/2
G15	PG15		15/32	3/8	13/16	2 1/2
G16	PG16	PGX16	1/2	1/2	1	3
G16X	PG16X		1/2	3/8	13/16	2 1/2
G17	PG17		17/32	1/2	1 1/8	3 1/8
G18	PG18	PGX18	9/16	1/2	1 1/8	3 1/8
G20	PG20	PGX20	5/8	5/8	1 5/16	3 7/16
G20X	PG20X		5/8	1/2	1 1/8	3 1/8
G22	PG22	PGX22	11/16	5/8	1 5/16	3 7/16
G22X	PG22X		11/16	1/2	1 5/16	3 5/16
G24	PG24	PGX24	3/4	5/8	1 5/16	3 7/16
G24X	PG24X		3/4	1/2	1 5/16	3 5/16
G24Y	PG24Y	PGX24Y	3/4	3/4	1 5/16	3 9/16
G26	PG26		13/16	5/8	1 1/2	3 5/8
G26Y			13/16	3/4	1 1/2	3 3/4
G28	PG28	PGX28	7/8	7/8	1 1/2	3 3/4
G28A			7/8	1/2	1 1/2	3 1/2
G28X	PG28X		7/8	5/8	1 1/2	3 5/8
G28Y	PG28Y	PGX28Y	7/8	3/4	1 1/2	3 3/4
G30	PG30		15/16	5/8	1 1/2	3 5/8
G30X			15/16	7/8	1 1/2	3 3/4
G30Y			15/16	3/4	1 1/2	3 3/4
G32	PG32	PGX32	1	1	1 5/8	4 1/8
G32A			1	1/2	1 1/2	3 1/2
G32W	PG32W	PGX32W	1	3/4	1 1/2	3 3/4
G32X	PG32X		1	5/8	1 1/2	3 5/8
G32Y	PG32Y		1	7/8	1 1/2	3 3/4
G36	PG36	PGX36	1 1/8	1	1 5/8	4 1/8
G36W	PG36W		1 1/8	3/4	1 5/8	3 7/8
G36X	PG36X		1 1/8	7/8	1 5/8	3 7/8
G40	PG40		1 1/4	1	1 5/8	4 1/8
G40W	PG40W		1 1/4	3/4	1 5/8	3 7/8
G40X	PG40X		1 1/4	7/8	1 5/8	3 7/8
G40Y	PG40Y	PGX40Y	1 1/4	1 1/4	1 5/8	4 1/8
G44	PG44		1 3/8	1	1 5/8	4 1/8
G44W	PG44W		1 3/8	3/4	1 5/8	3 7/8
G48	PG48		1 1/2	1	1 5/8	4 1/8
G48W	PG48W		1 1/2	3/4	1 5/8	3 7/8
G48X	PG48X	PGX48X	1 1/2	1 1/4	1 5/8	4 1/8
G52			1 5/8	1 1/4	1 5/8	4 1/8
G52W			1 5/8	3/4	1 1/2	3 7/8
G56	PG56		1 3/4	1 1/4	1 5/8	4 1/8
G56W			1 3/4	3/4	1 1/2	3 7/8
G60			1 7/8	1 1/4	1 5/8	4 1/8
G64	PG64		2	1 1/4	1 5/8	4 1/8
G64A			2	1 1/4	2 1/2	5
G64W			2	3/4	1 1/2	3 7/8
G64X			2	2	4	7 3/4
G80-4			2 1/2	2	4	7 5/8
G80-6			2 1/2	2	6	9 5/8

Shanks 2" And Larger Have Combination Drive

1 per tube

* item will be discontinued, after stock has depleted.

Technical Data

DRILLS

DRILLS
Cutting Condition

END MILLS

END MILLS
Cutting Condition

TAPS

TAPS
Cutting Condition

Others

Technical
Data

List No.6233

8% COBALT HIGH SPEED STEEL



DRILLS

DRILLS
Cutting Condition

END MILLS

END MILLS
Cutting Condition

TAPS

TAPS
Cutting Condition

Others

L6233	Diameter of Mill	Shank Diameter	Length of Cut	Overall Length
PGE8	1/4	3/8	1	3 1/16
PGE10	5/16	3/8	1 1/4	3 5/16
PGE12	3/8	3/8	1 1/2	3 1/4
PGE12A	3/8	3/8	1	2 3/4
PGE16	1/2	1/2	2	4
PGE16A	1/2	1/2	1 1/2	3 1/2
PGE16C	1/2	1/2	3	5
PGE20A	5/8	5/8	2	4 1/8
PGE24C	3/4	3/4	2 1/4	4 1/2
PGE28B	7/8	7/8	2 1/2	4 3/4
PGE32C	1	1	3	5 1/2
PGE36C	1 1/8	1	3	5 1/2
PGE40A	1 1/4	1 1/4	3	5 1/2
PGE48	1 1/2	1 1/4	3	5 1/2
PGE56	1 3/4	1 1/4	3	5 1/2
PGE64	2	1 1/4	3	5 1/2

1 per tube

* List No.261



HIGH SPEED STEEL



L261	Diameter of Mill	Shank Diameter	Length of Cut	Overall Length
C4	1/8	3/8	3/8	3 1/16
C5	5/32	3/8	7/16	3 1/8
C6	3/16	3/8	7/16	3 1/8
C7	7/32	3/8	1/2	3 1/8
C8	1/4	3/8	1/2	3 1/8
C9	9/32	3/8	9/16	3 1/8
C10	5/16	3/8	9/16	3 1/8
C11	11/32	3/8	9/16	3 1/8
C12	3/8	3/8	9/16	3 1/8
C13	13/32	1/2	13/16	3 3/4
C14	7/16	1/2	13/16	3 3/4
C15	15/32	1/2	13/16	3 3/4
C16	1/2	1/2	13/16	3 3/4
C18	9/16	5/8	1 1/8	4 1/2
C20	5/8	5/8	1 1/8	4 1/2
C22	11/16	3/4	1 5/16	5
C24	3/4	3/4	1 5/16	5
C26	13/16	7/8	1 9/16	5 1/2
C28	7/8	7/8	1 9/16	5 1/2
C30	15/16	1	1 5/8	5 7/8
C32	1	1	1 5/8	5 7/8

* item will be discontinued, after stock has depleted.

1 per tube

Technical Data

DRILLS

DRILLS
Cutting Condition

END MILLS

END MILLS
Cutting Condition

TAPS

TAPS
Cutting Condition

Others

METRIC SIZES, REGULAR, SINGLE END

List No.6230



Two Flute End Mill

8% COBALT HIGH SPEED STEEL



List No.6210



Four Flute Center Cutting

8% COBALT HIGH SPEED STEEL



(Unit) : mm

L6230	L6210	Diameter of Mill	Shank Diameter	Length of Cut	Overall Length
MPG1.0		1.0	6.0	2.0	50.0
MPG1.5		1.5	6.0	3.0	50.0
MPG2.0		2.0	6.0	7.0	50.0
MPG2.5	MPF2.5	2.5	6.0	7.0	50.0
MPG3.0	MPF3.0	3.0	6.0	9.0	50.0
MPG3.5	MPF3.5	3.5	8.0	12.0	60.0
MPG4.0	MPF4.0	4.0	8.0	12.0	60.0
MPG4.5	MPF4.5	4.5	8.0	15.0	60.0
MPG5.0	MPF5.0	5.0	8.0	15.0	60.0
MPG5.5	MPF5.5	5.5	8.0	15.0	60.0
MPG6.0	MPF6.0	6.0	8.0	15.0	60.0
MPG6.5	MPF6.5	6.5	10.0	20.0	65.0
MPG7.0	MPF7.0	7.0	10.0	20.0	65.0
MPG7.5	MPF7.5	7.5	10.0	20.0	65.0
MPG8.0	MPF8.0	8.0	10.0	20.0	65.0
MPG8.5	MPF8.5	8.5	10.0	25.0	75.0
MPG9.0	MPF9.0	9.0	10.0	25.0	75.0
MPG9.5	MPF9.5	9.5	10.0	25.0	75.0
MPG10	MPF10	10.0	10.0	25.0	75.0
* MPG11	MPF11	11.0	12.0	30.0	80.0
MPG12	MPF12	12.0	12.0	30.0	80.0
MPG13	MPF13	13.0	16.0	35.0	90.0
MPG14	MPF14	14.0	16.0	35.0	90.0
MPG15	MPF15	15.0	16.0	40.0	95.0
MPG16	MPF16	16.0	16.0	40.0	95.0
MPG17	MPF17	17.0	20.0	40.0	105.0
* MPG18	MPF18	18.0	20.0	40.0	105.0
MPG19	MPF19	19.0	20.0	45.0	110.0
MPG20	MPF20	20.0	20.0	45.0	110.0
* MPG21	* MPF21	21.0	20.0	45.0	110.0
* MPG22	* MPF22	22.0	20.0	45.0	110.0
* MPG23	* MPF23	23.0	25.0	50.0	120.0
MPG24	MPF24	24.0	25.0	50.0	120.0
MPG25	* MPF25	25.0	25.0	50.0	120.0
MPG26	MPF26	26.0	25.0	50.0	120.0
* MPG27	* MPF27	27.0	25.0	55.0	125.0
* MPG28	MPF28	28.0	25.0	55.0	125.0
* MPG29	* MPF29	29.0	25.0	55.0	125.0
MPG30	MPF30	30.0	25.0	55.0	125.0
* MPG31	* MPF31	31.0	32.0	60.0	145.0
* MPG32	* MPF32	32.0	32.0	60.0	145.0
* MPG33	* MPF33	33.0	32.0	60.0	145.0
* MPG34	* MPF34	34.0	32.0	60.0	145.0
* MPG35	* MPF35	35.0	32.0	60.0	145.0
* MPG36	* MPF36	36.0	32.0	60.0	145.0
* MPG37	* MPF37	37.0	32.0	65.0	150.0
* MPG38	* MPF38	38.0	32.0	65.0	150.0
* MPG39	* MPF39	39.0	32.0	65.0	150.0
* MPG40	* MPF40	40.0	32.0	65.0	150.0
* MPG42	* MPF42	42.0	32.0	65.0	150.0
* MPG45	* MPF45	45.0	32.0	70.0	155.0
* MPG48	* MPF48	48.0	32.0	70.0	155.0
* MPG50	* MPF50	50.0	32.0	70.0	155.0

* JAPAN STOCK ITEM : Please allow 2-3 weeks delivery

1 per tube

* List No.211



HIGH SPEED STEEL



List No.6211X



8% COBALT "SG" COATED



List No.6211M



8% COBALT HIGH SPEED STEEL



L211	L6211M	L6211X	Diameter of Mill	Shank Diameter	Length of Cut	Number of Flutes	Overall Length
FC4	PFC4	PFCX4	1/8	3/8	3/8	4	2 5/16
FC6	PFC6	PFCX6	3/16	3/8	1/2	4	2 3/8
FC8	PFC8	PFCX8	1/4	3/8	5/8	4	2 7/16
FC10	PFC10	PFCX10	5/16	3/8	3/4	4	2 1/2
FC12	PFC12	PFCX12	3/8	3/8	3/4	4	2 1/2
FC16	PFC16	PFCX16	1/2	1/2	1 1/4	4	3 1/4
	PFC16A	PFCX16A	1/2	1/2	1 1/4	6	3 1/4
FC20	PFC20	PFCX20	5/8	5/8	1 5/8	4	3 3/4
	PFC20A	PFCX20A	5/8	5/8	1 5/8	6	3 3/4
FC22			11/16	5/8	1 5/8	4	3 3/4
FC24	PFC24	PFCX24	3/4	3/4	1 5/8	4	3 7/8
	PFC24A	PFCX24A	3/4	3/4	1 5/8	6	3 7/8
FC28	PFC28	PFCX28	7/8	7/8	1 7/8	4	4 1/8
	PFC28A	PFCX28A	7/8	7/8	1 7/8	6	4 1/8
FC32	PFC32	PFCX32	1	1	2	4	4 1/2
	PFC32A	PFCX32A	1	1	2	6	4 1/2
FC36	PFC36	PFCX36	1 1/8	1	2	4	4 1/2
	PFC36A	PFCX36A	1 1/8	1	2	6	4 1/2
FC40	PFC40	PFCX40	1 1/4	1 1/4	2	4	4 1/2
	PFC40A	PFCX40A	1 1/4	1 1/4	2	6	4 1/2
FC48	PFC48	PFCX48	1 1/2	1 1/4	2	4	4 1/2
	PFC48A	PFCX48A	1 1/2	1 1/4	2	6	4 1/2
FC56			1 3/4	1 1/4	2	4	4 1/2
FC64			2	1 1/4	2	4	4 1/2
	PFC64		2	1 1/4	2	6	4 1/2
	PFC64A		2	1 1/4	4	6	6 1/2

* item will be discontinued, after stock has depleted.

1 per tube

Technical Data

DRILLS

DRILLS
Cutting Condition

END MILLS

END MILLS
Cutting Condition

TAPS

TAPS
Cutting Condition

Others

MULTI FLUTE END MILLS / LONG SINGLE END, CENTER CUTTING

Technical Data

*** List No.213**



Long, Single End

HIGH SPEED STEEL



List No.6213



Long, Single End

8% COBALT HIGH SPEED STEEL



DRILLS

DRILLS Cutting Condition

END MILLS

END MILLS Cutting Condition

TAPS

TAPS Cutting Condition

Others

L213	L6213	Diameter of Mill	Shank Diameter	Length of Cut	No. of Flutes	Overall Length
FLC8	PFLC8	1/4	3/8	1 1/4	4	3 1/16
FLC10	PFLC10	5/16	3/8	1 3/8	4	3 1/8
FLC12	PFLC12	3/8	3/8	1 1/2	4	3 1/4
FLC16	PFLC16	1/2	1/2	2	4	4
FLC20	PFLC20	5/8	5/8	2 1/2	4	4 5/8
FLC24	PFLC24	3/4	3/4	3	4	5 1/4
FLC28	PFLC28	7/8	7/8	3 1/2	4	5 3/4
FLC32	PFLC32	1	1	4	4	6 1/2
FLC40	PFLC40	1 1/4	1 1/4	4	4	6 1/2
FLC48		1 1/2	1 1/4	4	4	6 1/2
FLC56		1 3/4	1 1/4	4	4	6 1/2
FLC64		2	1 1/4	4	4	6 1/2

* item will be discontinued, after stock has depleted.

1 per tube

**FOUR FLUTE END MILLS /
EXTRA LONG SINGLE END, CENTER CUTTING**

*** List No.215**



Extra Long, Single End

HIGH SPEED STEEL



L215	Diameter of Mill	Shank Diameter	Length of Cut	Number of Flutes	Overall Length
FXC8	1/4	3/8	1 3/4	4	3 9/16
FXC10	5/16	3/8	2	4	3 3/4
FXC12	3/8	3/8	2 1/2	4	4 1/4
FXC16	1/2	1/2	3	4	5
FXC20	5/8	5/8	4	4	6 1/8
FXC24	3/4	3/4	4	4	6 1/4
FXC28	7/8	7/8	5	4	7 1/4
FXC32	1	1	6	4	8 1/2
FXC40	1 1/4	1 1/4	6	4	8 1/2

* item will be discontinued, after stock has depleted.

1 per tube

Technical Data

DRILLS

DRILLS
Cutting Condition

END MILLS

END MILLS
Cutting Condition

TAPS

TAPS
Cutting Condition

Others

Technical
Data* **List No.271**Center Cutting
Four Flute/Double End**HIGH SPEED STEEL**

DRILLS

DRILLS
Cutting Condition

END MILLS

END MILLS
Cutting Condition

TAPS

TAPS
Cutting Condition

Others

L271	L6271	Diameter of Mill	Shank Mill	Length of Cut	Number of Flutes	Overall Length
BC4	PBC4	1/8	3/8	3/8	4	3 1/16
BC6	PBC6	3/16	3/8	1/2	4	3 1/4
BC8	PBC8	1/4	3/8	5/8	4	3 3/8
BC10	PBC10	5/16	3/8	3/4	4	3 1/2
BC12	PBC12	3/8	3/8	3/4	4	3 1/2
BC16	PBC16	1/2	1/2	1	4	4 1/8
BC20	PBC20	5/8	5/8	1 3/8	4	5
BC24	PBC24	3/4	3/4	1 5/8	4	5 5/8
BC28	PBC28	7/8	7/8	1 7/8	4	6 1/8
BC32	PBC32	1	1	1 7/8	4	6 3/8

* item will be discontinued, after stock has depleted.

1 per tube

GS-Mill 2 Flute List No. 9382

Work Material	Structural Steels Carbon Steels Cast Irons 150-250HB		Alloy Steels Hardened Steels 25-35HRC		Hardened Steels 35-45HRC		Hardened Steels 45-55HRC		Stainless Steels		Titanium Alloys Ti-6Al-4V		Nickel Alloys Inconel718		
	230 - 280 SFM		215 - 270 SFM		150 - 185 SFM		110 - 135 SFM		110 - 135 SFM		85 - 100 SFM		70 - 85 SFM		
Milling Conditions	RPM	Feed (IPM)	RPM	Feed (IPM)	RPM	Feed (IPM)	RPM	Feed (IPM)	RPM	Feed (IPM)	RPM	Feed (IPM)	RPM	Feed (IPM)	
Dia. of Mill (mm)															
2	11,200	13.4	10,500	9.4	7,300	5.1	5,300	3.1	5,300	3.5	4,100	2.8	3,300	2.0	
4	6,400	18.1	6,000	12.6	4,200	7.1	3,000	4.3	3,000	5.1	2,300	3.5	1,900	2.8	
6	4,600	21.7	4,300	15.4	3,000	8.3	2,200	5.1	2,200	5.9	1,600	3.9	1,400	3.1	
8	3,400	21.7	3,200	15.4	2,200	8.3	1,600	5.1	1,600	5.9	1,200	3.9	1,000	3.1	
10	2,800	22.0	2,600	15.4	1,800	8.3	1,300	5.1	1,300	5.9	960	3.9	800	3.1	
12	2,300	22.0	2,200	15.7	1,500	8.3	1,100	5.1	1,100	5.9	800	3.9	700	3.1	
Depth of Cut	a _a	1.5D						1.0D		1.5D		1.0D			
	a _r	0.1D				0.05D		0.02D		0.1D		0.05D			
	H	0.5D				0.3D		0.05D		0.5D		0.05D			

- 1) When slotting in Stainless Steels, reduce the RPM 40%, and the feed rate 60% of table values.
- 2) Use coolant when machining Stainless Steels, Nickel Alloys and Titanium Alloys.
- 3) Adjust milling condition when unusual vibration or sound occurs.

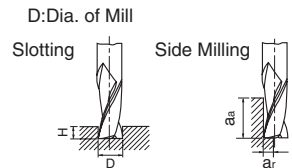

GS-Mill 4 Flute List No. 9384

Conventional Condition

Work Material	Carbon Steels Cast Irons 150-250HB		Alloy Steels Hardened Steels 25-35HRC		Hardened Steels 35-45HRC		Hardened Steels 45-55HRC		Stainless Steels		Titanium Alloys Ti-6Al-4V		Nickel Alloys Inconel718		
	230 - 280 SFM		215 - 270 SFM		150 - 185 SFM		110 - 135 SFM		110 - 135 SFM		85 - 100 SFM		70 - 85 SFM		
Milling Conditions	RPM	Feed (IPM)	RPM	Feed (IPM)	RPM	Feed (IPM)	RPM	Feed (IPM)	RPM	Feed (IPM)	RPM	Feed (IPM)	RPM	Feed (IPM)	
Dia. of Mill (mm)															
2	12,800	22.4	12,000	15.0	8,300	9.1	6,000	5.9	6,000	5.1	4,100	3.1	3,700	2.8	
4	6,800	28.7	6,400	19.3	4,400	11.8	3,200	7.9	3,200	6.7	2,100	3.9	2,000	3.5	
6	4,600	30.3	4,300	20.5	3,000	12.6	2,200	8.3	2,200	7.1	1,400	3.9	1,400	3.9	
8	3,400	30.3	3,200	20.5	2,200	12.6	1,600	8.3	1,600	7.1	1,100	4.3	1,000	3.9	
10	2,800	30.7	2,600	20.5	1,800	12.6	1,300	8.3	1,300	7.1	900	4.7	800	3.9	
12	2,300	30.7	2,200	20.9	1,500	12.6	1,100	8.3	1,100	7.1	700	3.9	700	3.9	
Depth of Cut	a _a	1.5D						1.0D		1.5D		1.0D			
	a _r	0.1D				0.05D		0.02D		0.1D		0.05D			
	H	0.5D				0.2D		0.05D		0.3D		0.1D			

- 1) When slotting in Stainless Steels, reduce the RPM 40%, and the feed rate 60% of table values.
- 2) Use coolant when machining Stainless Steels, Nickel Alloys and Titanium Alloys.
- 3) Adjust milling condition when unusual vibration or sound occurs.

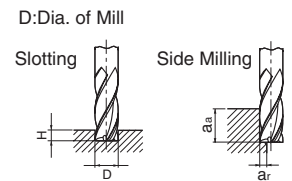

High Speed Condition

Work Material	Carbon Steels Cast Irons 150-250HB		Alloy Steels Hardened Steels 25-35HRC		Hardened Steels 35-45HRC		Hardened Steels 45-55HRC		Stainless Steels		
	985 - 990 SFM		985 - 990 SFM		820 - 830 SFM		645 - 655 SFM		325 - 335 SFM		
Milling Conditions	RPM	Feed (IPM)	RPM	Feed (IPM)	RPM	Feed (IPM)	RPM	Feed (IPM)	RPM	Feed (IPM)	
Dia. of Mill (mm)											
2	47,800	86.6	47,800	63.0	39,800	47.2	31,800	35.4	15,900	15.7	
4	23,900	102.4	23,900	74.8	19,900	55.1	15,900	43.3	8,000	19.3	
6	16,000	106.3	16,000	78.7	13,300	59.1	10,600	47.2	5,300	20.1	
8	12,000	106.3	12,000	78.7	10,000	59.1	8,000	47.2	4,000	20.5	
10	9,600	106.3	9,600	78.7	8,000	59.1	6,400	47.2	3,200	20.5	
12	8,000	106.3	8,000	78.7	6,700	59.1	5,300	47.2	2,700	20.5	
Depth of Cut	a _a	1.5D						1.0D		1.5D	
	a _r	0.05D						0.02D		0.05D	

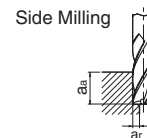

- 1) When slotting in Stainless Steels, reduce the RPM 40%, and the feed rate 60% of table values.
- 2) Use coolant when machining Stainless Steels, Nickel Alloys and Titanium Alloys.
- 3) Adjust milling condition when unusual vibration or sound occurs.

Technical Data

DRILLS

DRILLS Cutting Condition

END MILLS

END MILLS Cutting Condition

TAPS

TAPS Cutting Condition

Others

Technical Data

DRILLS

DRILLS
Cutting Condition

END MILLS

END MILLS
Cutting Condition

TAPS

TAPS
Cutting Condition

Others

GS-Mill Ball List No. 9386

Conventional Condition

Work Material	Carbon Steels Cast Irons 150~250HB		Alloy Steels Hardened Steels 25~35HRC		Hardened Steels 35~45HRC		Hardened Steels 45~55HRC		Stainless Steels		Titanium Alloys Ti-6Al-4V		Nickel Alloys Inconel718		
	RPM	Feed (IPM)	RPM	Feed (IPM)	RPM	Feed (IPM)	RPM	Feed (IPM)	RPM	Feed (IPM)	RPM	Feed (IPM)	RPM	Feed (IPM)	
Milling Conditions	395 - 495 SFM		265 - 330 SFM		210 - 270 SFM		180 - 235 SFM		180 - 235 SFM		130 - 175 SFM		130 - 175 SFM		
Ball Radius (mm)															
R1	19,100	30.3	12,800	14.6	10,200	10.6	8,900	7.5	8,900	8.3	6,400	6.3	6,400	4.7	
R2	10,800	43.3	7,200	21.7	5,700	15.7	5,000	11.0	5,000	12.2	3,600	8.3	3,600	7.1	
R3	7,700	51.2	5,200	26.0	4,100	18.9	3,600	13.0	3,600	15.0	2,600	9.1	2,600	8.3	
R4	6,000	55.1	4,000	27.6	3,200	20.1	2,800	14.2	2,800	15.7	2,000	9.8	2,000	9.1	
R5	4,800	55.1	3,200	27.6	2,600	20.5	2,300	14.6	2,300	16.1	1,600	9.8	1,600	9.1	
R6	4,000	55.1	2,700	28.0	2,200	20.9	1,900	14.6	1,900	16.1	1,400	9.4	1,400	9.4	
Depth of Cut	a _a	0.1D				0.05D				0.1D		0.05D		0.05D	
	Pf	0.2D				0.1D				0.2D		0.1D		0.1D	

- 1) Use coolant when machining Stainless Steels, Nickel Alloys and Titanium Alloys.
- 2) Adjust milling condition when unusual vibration or sound occurs.

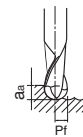

High Speed Condition

Work Material	Carbon Steels Cast Irons 150~250HB		Alloy Steels Hardened Steels 25~35HRC		Hardened Steels 35~45HRC		Hardened Steels 45~55HRC		Stainless Steels		
	RPM	Feed (IPM)	RPM	Feed (IPM)	RPM	Feed (IPM)	RPM	Feed (IPM)	RPM	Feed (IPM)	
Milling Conditions	1000 - 1050 SFM		820 - 830 SFM		730 - 740 SFM		485 - 495 SFM		735 - 745 SFM		
Ball Radius (mm)											
R1	51,000	82.7	39,800	51.2	35,700	37.8	23,700	25.2	35,700	37.8	
R2	25,500	106.3	19,900	66.9	17,900	51.2	11,900	32.7	17,900	51.2	
R3	17,000	118.1	13,300	74.8	11,900	55.1	7,900	36.2	11,900	55.1	
R4	12,800	122.0	10,000	78.7	9,000	59.1	6,000	37.8	9,000	59.1	
R5	10,200	122.0	8,000	78.7	7,200	59.1	4,800	37.8	7,200	59.1	
R6	8,500	122.0	6,700	78.7	6,000	59.1	4,000	37.8	6,000	59.1	
Depth of Cut	a _a	0.05D				0.02D				0.05D	
	Pf	0.1D				0.05D				0.1D	

- 1) When using low RPM machines, use the maximum RPM and adjust the feed rate.
- 2) Use coolant when machining Stainless Steels, Nickel Alloys and Titanium Alloys.
- 3) Adjust milling condition when unusual vibration or sound occurs.

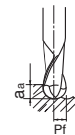

GS Mill Hard List No. 9398

Conventional Condition

Work Material	Carbon Steels, Alloy Steels ~35HRC		Pre-Hardened Steels, Mold Steels 35~45HRC		Hardened Steels, H13 45~55HRC		Hardened Steels, D2 55~60HRC		Hardened Steels, M2 60~65HRC		Hardened Steels, M35, PM 65~70HRC		
	400 - 460 SFM		350 - 420 SFM		280 - 320 SFM		220 - 250 SFM		200 - 220 SFM		140 - 160 SFM		
Milling Conditions	RPM	Feed (IPM)	RPM	Feed (IPM)	RPM	Feed (IPM)	RPM	Feed (IPM)	RPM	Feed (IPM)	RPM	Feed (IPM)	
Dia. of Mill (mm)													
1	20,000	21.3	20,000	15.4	15,600	10.2	12,300	6.3	11,100	5.5	7,800	3.7	
2	19,000	43.3	17,200	30.3	13,400	20.9	10,500	12.6	9,500	10.6	6,700	7.5	
3	15,000	84.6	13,400	60.6	10,400	41.3	8,200	25.6	7,400	21.3	5,200	15.0	
4	11,200	94.5	10,000	68.5	7,800	46.5	6,100	28.7	5,600	23.6	3,900	16.5	
5	9,000	106.3	8,000	76.0	6,200	51.2	4,900	31.9	4,400	26.4	3,100	18.5	
6	7,500	106.3	6,700	76.0	5,200	51.2	4,100	31.9	3,700	26.4	2,600	18.5	
8	5,600	106.3	5,000	76.0	3,900	51.2	3,050	31.9	2,800	26.4	1,950	18.5	
10	4,500	106.3	4,000	76.0	3,100	51.2	2,450	31.9	2,200	26.4	1,550	18.5	
12	3,750	106.3	3,350	76.0	2,600	51.2	2,050	31.9	1,850	26.4	1,300	18.5	
16	2,800	98.4	2,500	70.9	1,950	48.0	1,530	29.9	1,400	24.8	980	17.3	
20	2,250	82.7	2,000	60.6	1,550	41.3	1,230	25.6	1,100	21.3	780	15.0	
Depth of Cut	a _a	1~1.5D											
	a _r	0.1D				0.05D				0.02D			
	H	0.1D				0.05D				~0.05D Max.0.5mm			

Adjust milling condition when unusual vibration or sound occurs.

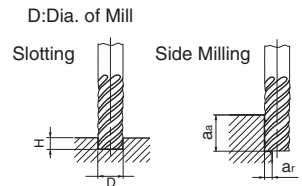

High Speed Condition

Work Material	Carbon Steels, Alloy Steels ~35HRC		Pre-Hardened Steels, Mold Steels 35~45HRC		Hardened Steels, H13 45~55HRC		Hardened Steels, D2 55~60HRC		Hardened Steels, M2 60~65HRC		
	800 - 1000 SFM		800 - 1000 SFM		800 - 1000 SFM		600 - 740 SFM		400 - 490 SFM		
Milling Conditions	RPM	Feed (IPM)	RPM	Feed (IPM)	RPM	Feed (IPM)	RPM	Feed (IPM)	RPM	Feed (IPM)	
Dia. of Mill (mm)											
1	48,000	49.2	48,000	49.2	48,000	49.2	48,000	36.6	38,000	27.6	
2	48,000	112.2	48,000	112.2	48,000	112.2	36,000	63.0	24,000	39.4	
3	32,000	192.9	32,000	192.9	32,000	192.9	24,000	107.9	16,000	66.9	
4	24,000	204.7	24,000	204.7	24,000	204.7	18,000	114.2	12,000	70.9	
5	19,200	228.3	19,200	228.3	19,200	228.3	14,300	126.0	9,600	78.7	
6	16,000	228.3	16,000	228.3	16,000	228.3	12,000	126.0	8,000	78.7	
8	12,000	228.3	12,000	228.3	12,000	228.3	9,000	126.0	6,000	78.7	
10	9,600	228.3	9,600	228.3	9,600	228.3	7,200	126.0	4,800	78.7	
12	8,000	228.3	8,000	228.3	8,000	228.3	6,000	126.0	4,000	78.7	
16	6,000	212.6	6,000	212.6	6,000	212.6	4,500	118.1	3,000	74.8	
20	4,800	181.1	4,800	181.1	4,800	181.1	3,600	101.6	2,400	63.0	
Depth of Cut	a _a	1~1.5D									
	a _r	0.1D		0.05D			0.02D		0.01D		

- 1) When using low RPM machines, use the maximum RPM and adjust the feed rate.
- 2) Recommend dry machining when high speed milling.
- 3) Adjust milling condition when unusual vibration or sound occurs.

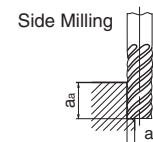

Technical Data

DRILLS

DRILLS Cutting Condition

END MILLS

END MILLS Cutting Condition

TAPS

TAPS Cutting Condition

Others

Technical Data

DRILLS

DRILLS Cutting Condition

END MILLS

END MILLS Cutting Condition

TAPS

TAPS Cutting Condition

Others

GEO Mill Hard List No. 9399

Conventional Condition

Work Material	Carbon Steels, Alloy Steels ~35HRC		Pre-Hardened Steels, Mold Steels 35~45HRC		Hardened Steels, H13 45~55HRC		Hardened Steels, D2 55~60HRC		Hardened Steels, M2 60~65HRC		Hardened Steels, M35, PM 65~70HRC		
	Milling Conditions		Milling Conditions		Milling Conditions		Milling Conditions		Milling Conditions		Milling Conditions		
Dia. of Mill (inch)	400 - 460 SFM		350 - 420 SFM		280 - 320 SFM		220 - 250 SFM		200 - 220 SFM		140 - 160 SFM		
	RPM	Feed (IPM)	RPM	Feed (IPM)	RPM	Feed (IPM)	RPM	Feed (IPM)	RPM	Feed (IPM)	RPM	Feed (IPM)	
1/4	7,100	106.3	6,350	76.0	4,900	51.2	3,850	31.9	3,500	26.4	2,450	18.5	
3/8	4,700	106.3	4,200	76.0	3,250	51.2	2,600	31.9	2,300	26.4	1,650	18.5	
1/2	3,550	106.3	3,150	76.0	2,450	51.2	1,950	31.9	1,750	26.4	1,250	18.5	
5/8	2,800	98.4	2,500	70.9	1,950	48.0	1,550	30.0	1,400	24.8	980	17.3	
3/4	2,350	86.0	2,100	62.4	1,650	44.5	1,300	27.7	1,150	22.4	820	16.1	
Depth of Cut	a _a	1~1.5D											
	a _r	0.1D				0.05D				0.02D			
	H	0.1D				0.05D				~0.05D Max.0.5mm			

Adjust milling condition when unusual vibration or sound occurs.

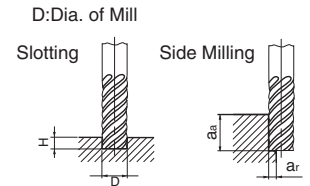

High Speed Condition

Work Material	Carbon Steels, Alloy Steels ~35HRC		Pre-Hardened Steels, Mold Steels 35~45HRC		Hardened Steels, H13 45~55HRC		Hardened Steels, D2 55~60HRC		Hardened Steels, M2 60~65HRC		
	Milling Conditions		Milling Conditions		Milling Conditions		Milling Conditions		Milling Conditions		
Dia. of Mill (inch)	800 - 1000 SFM		800 - 1000 SFM		800 - 1000 SFM		600 - 740 SFM		400 - 490 SFM		
	RPM	Feed (IPM)	RPM	Feed (IPM)	RPM	Feed (IPM)	RPM	Feed (IPM)	RPM	Feed (IPM)	
1/4	15,100	228.3	15,100	228.3	15,100	228.3	11,500	126.0	7,500	78.7	
3/8	10,000	228.3	10,000	228.3	10,000	228.3	7,500	126.0	5,000	78.7	
1/2	7,550	228.3	7,550	228.3	7,550	228.3	5,750	126.0	3,750	78.7	
5/8	6,000	212.6	6,000	212.6	6,000	212.6	4,500	118.1	3,000	74.8	
3/4	5,000	187.5	5,000	187.5	5,000	187.5	3,750	104.6	2,500	68.2	
Depth of Cut	a _a	1~1.5D									
	a _r	0.1D		0.05D				0.02D		0.01D	

- 1) When using low RPM machines, use the maximum RPM and adjust the feed rate.
- 2) Recommend dry machining when high speed milling.
- 3) Adjust milling condition when unusual vibration or sound occurs.

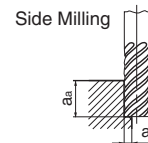

GS Mill Hard Ball List No. 9422

Work Material		Mold Steels, Pre-Hardened Steels (40 - 50 HRC)		Hardened Steels (50 - 55 HRC)		Hardened Steels (55 - 60 HRC)		Hardened Steels (60 - 65 HRC)	
Milling Conditions		750 - 780 SFM		751 - 780 SFM		550 - 580 SFM		400 - 430 SFM	
Ball Radius (mm)		RPM	Feed (IPM)	RPM	Feed (IPM)	RPM	Feed (IPM)	RPM	Feed (IPM)
R0.2		50,000	19.7	50,000	19.7	50,000	19.7	50,000	19.7
R0.3		50,000	31.5	50,000	31.5	50,000	31.5	50,000	27.6
R0.5		50,000	55.1	50,000	55.1	50,000	51.2	42,000	39.4
R0.75		50,000	78.7	50,000	78.7	37,300	55.1	28,000	39.4
R1		38,100	82.7	38,100	82.7	28,000	55.1	21,000	39.4
R1.25		30,500	82.7	30,500	82.7	22,400	55.1	16,800	39.4
R1.5		25,400	82.7	25,400	82.7	18,700	55.1	14,000	39.4
R2		19,100	82.7	19,100	82.7	14,000	55.1	10,500	39.4
R2.5		15,300	82.7	15,300	82.7	11,200	55.1	8,400	39.4
R3		12,700	82.7	12,700	82.7	9,300	55.1	7,000	39.4
R4		9,500	82.7	9,500	82.7	7,000	55.1	5,300	39.4
R5		7,600	82.7	7,600	82.7	5,600	55.1	4,200	39.4
R6		6,400	82.7	6,400	82.7	4,700	55.1	3,500	39.4
Depth of Cut	a _a	0.08D				0.05D			
	Pf	0.25D				0.15D			

D: Dia. of Mill
R: Ball Radius

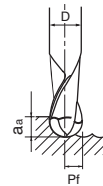

- 1) Recommended oil mist process.
- 2) When depth of the cut is reduced, it can increase feed rate more.
- 3) When using machine with low RPM, use maximum speed and adjust the feed rate relatively.
- 4) Adjust milling condition when unusual vibration or sound occurs.

GEO Mill Hard Ball List No. 9423

Conventional Condition

Work Material		Mold Steels, Pre-Hardened Steels (40 - 50 HRC)		Hardened Steels (50 - 55 HRC)		Hardened Steels (55 - 60 HRC)		Hardened Steels (60 - 65 HRC)	
Milling Conditions		750 - 780 SFM		751 - 780 SFM		550 - 580 SFM		400 - 430 SFM	
Dia. of Mill (inch)	Ball Radius (inch)	RPM	Feed (IPM)	RPM	Feed (IPM)	RPM	Feed (IPM)	RPM	Feed (IPM)
1/4	1/8	12,000	82.7	12,000	82.7	8,800	55.1	6,600	39.4
3/8	3/16	8,000	82.7	8,000	82.7	5,900	55.1	4,400	39.4
1/2	1/4	6,000	82.7	6,000	82.7	4,400	55.1	3,300	39.4
5/8	5/16	4,800	76.2	4,800	76.2	3,550	50.7	2,650	36.2
3/4	3/8	4,000	67.8	4,000	67.8	2,950	45.2	2,200	32.3
Depth of Cut	a _a	0.08D				0.05D			
	Pf	0.25D				0.15D			

D: Dia. of Mill
R: Ball Radius

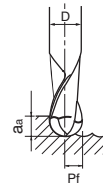

- 1) Recommended oil mist process.
- 2) When depth of the cut is reduced, it can increase feed rate more.
- 3) When using machine with low RPM, use maximum speed and adjust the feed rate relatively.
- 4) Adjust milling condition when unusual vibration or sound occurs.

Technical Data

DRILLS

DRILLS Cutting Condition

END MILLS

END MILLS Cutting Condition

TAPS

TAPS Cutting Condition

Others

X's-mill Geo List No. 9321

Fractional

Work Material	Structural Steels Carbon Steels Cast Irons 150-250HB		Alloy Steels Hardened Steels 25~35HRC		Hardened Steels 40~50HRC		Stainless Steels		Titanium Alloys Ti-6Al-4V		Nickel Alloys Inconel718		
	Milling Conditions		285 - 295 SFM		170 - 180 SFM		135 - 145 SFM		155 - 165 SFM		110 - 115 SFM		75 - 85 SFM
Dia. of Mill (inch)	RPM	Feed (IPM)	RPM	Feed (IPM)	RPM	Feed (IPM)	RPM	Feed (IPM)	RPM	Feed (IPM)	RPM	Feed (IPM)	
	1/8	9,000	31.5	5,500	17.5	4,500	13.5	5,000	12.5	3,500	6.3	2,500	4.5
3/16	6,000	35.0	3,600	18.0	3,000	14.5	3,200	14.5	2,240	6.3	1,600	4.5	
1/4	4,500	37.0	2,700	19.5	2,200	15.0	2,500	19.0	1,750	6.7	1,250	4.8	
5/16	3,600	39.0	2,200	24.0	1,800	15.5	2,000	20.0	1,400	7.7	1,000	5.5	
3/8	3,000	39.0	1,800	24.0	1,500	15.5	1,600	21.0	1,120	8.7	800	6.2	
7/16	2,500	38.0	1,500	22.0	1,200	15.0	1,400	20.5	980	8.4	700	6.0	
1/2	2,200	35.0	1,300	20.0	1,100	14.5	1,200	17.5	840	7.7	600	5.5	
5/8	1,800	25.0	1,100	17.5	900	11.5	1,000	15.5	700	6.3	500	4.5	
3/4	1,500	20.0	900	13.0	750	10.5	800	11.5	560	5.5	400	3.9	
1	1,100	19.0	650	11.5	550	9.5	600	11.0	420	5.2	300	3.7	
Depth of Cut	a _a	1.5D											
	a _r	0.1D				0.05D		0.1D		0.05D			
	H	1D				0.2D		0.3D		0.2D			

- 1) When slotting in Stainless Steels, reduce the RPM 40%, and the feed rate 60% of table values.
- 2) Use coolant when machining Stainless Steels, Nickel Alloys and Titanium Alloys.
- 3) Adjust milling condition when unusual vibration or sound occurs.

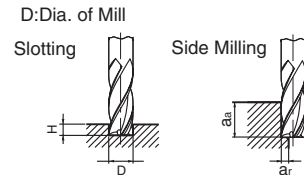

X's-mill Geo, X's-mill Geo Radius List No. 9322, 9324

Metric

Work Material	Structural Steels Carbon Steels Cast Irons 150-250HB		Alloy Steels Hardened Steels 25~35HR		Hardened Steels 40~50HRC		Stainless Steels		Titanium Alloys Ti-6Al-4V		Nickel Alloys Inconel718		
	Milling Conditions		200 - 295 SFM		125 - 180 SFM		85 - 145 SFM		115 - 165 SFM		80 - 115 SFM		55 - 85 SFM
Dia. of Mill (mm)	RPM	Feed (IPM)	RPM	Feed (IPM)	RPM	Feed (IPM)	RPM	Feed (IPM)	RPM	Feed (IPM)	RPM	Feed (IPM)	
	2	9,900	28.3	6,000	16.9	4,000	12.6	5,500	12.6	3,900	7.1	2,600	4.7
4	6,600	31.5	4,500	17.7	3,000	15.0	4,000	15.0	2,500	5.9	2,000	4.7	
6	4,800	37.8	3,000	18.9	2,500	15.0	3,000	15.0	1,800	7.1	1,200	4.7	
8	3,600	39.4	2,200	24.0	2,000	15.7	2,000	15.7	1,200	6.7	1,000	5.5	
10	2,800	39.4	1,800	24.0	1,500	15.7	1,700	15.7	1,100	8.7	800	6.3	
12	2,400	37.4	1,500	21.7	1,200	15.0	1,500	15.0	930	7.5	700	5.5	
14	2,200	34.6	1,300	19.3	1,000	14.2	1,200	14.2	800	7.1	600	5.1	
16	1,800	25.6	1,100	16.5	800	11.8	1,000	11.8	700	6.7	500	4.7	
18	1,600	22.8	1,000	14.2	750	10.6	900	10.6	620	6.3	450	4.3	
20	1,400	19.7	900	13.0	700	9.8	820	9.8	560	5.5	400	3.9	
Depth of Cut	a _a	1.5D											
	a _r	0.1D				0.05D		0.1D		0.05D			
	H	1D				0.2D		0.3D		0.2D			

- 1) When slotting in Stainless Steels, reduce the RPM 40%, and the feed rate 60% of table values.
- 2) Use coolant when machining Stainless Steels, Nickel Alloys and Titanium Alloys.
- 3) Adjust milling condition when unusual vibration or sound occurs.

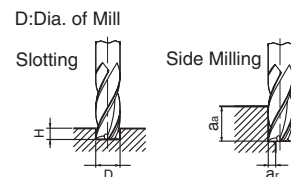

Technical Data

DRILLS

DRILLS Cutting Condition

END MILLS

END MILLS Cutting Condition

TAPS

TAPS Cutting Condition

Others

X's-mill Geo Slot List No. 9338

Side Milling & Slotting Condition

Work Material	Carbon Steels Cast Irons 150~250HB		Alloy Steels Hardened Steels 25~35HRC		Hardened Steels 35~45HRC		Stainless Steels 304, 316		Titanium Alloys Ti-6Al-4V		Nickel Alloys Inconel718		
	185 - 300 SFM		125 - 185 SFM		85 - 155 SFM		115 - 185 SFM		80 - 115 SFM		55 - 85 SFM		
Milling Conditions													
Dia. of Mill (mm)	RPM	Feed (IPM)	RPM	Feed (IPM)	RPM	Feed (IPM)	RPM	Feed (IPM)	RPM	Feed (IPM)	RPM	Feed (IPM)	
2	9,000	21.3	6,000	12.6	4,000	9.4	5,500	9.4	3,900	5.5	2,600	3.5	
4	6,600	23.6	4,500	13.4	3,000	11.0	4,000	9.4	2,500	4.7	2,000	3.5	
6	4,800	28.3	3,000	14.2	2,500	11.0	3,000	14.2	1,800	5.5	1,200	3.5	
8	3,600	29.5	2,200	18.1	2,000	11.8	2,000	15.4	1,200	4.7	1,000	3.9	
10	2,800	29.5	1,800	18.1	1,500	11.8	1,700	16.1	1,100	6.7	800	4.7	
12	2,400	28.0	1,500	16.1	1,200	11.0	1,500	15.0	930	5.5	700	3.9	
14	2,200	26.0	1,300	14.6	1,000	10.6	1,200	12.6	800	5.1	600	3.7	
16	1,800	19.3	1,100	12.6	800	9.1	1,000	10.6	700	5.1	500	3.5	
Depth of Cut	1.5D												
	a _a	0.1D		0.05D		0.1D		0.05D		0.05D			
	H	1D		0.2D		0.3D		0.2D		0.2D			

- 1) When slotting in Stainless Steels, reduce the RPM 40%, and the feed rate 60% of table values.
- 2) Use coolant when machining Stainless Steels, Nickel Alloys and Titanium Alloys.
- 3) Adjust milling condition when unusual vibration or sound occurs.

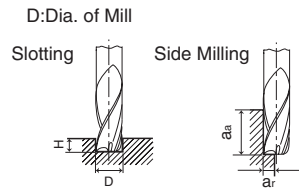

Plunging Condition

Work Material	Carbon Steels Cast Irons 150~250HB		Alloy Steels Hardened Steels 25~35HRC		Hardened Steels 40~50HRC		Stainless Steels		Titanium Alloys Ti-6Al-4V		Nickel Alloys Inconel718	
	185 - 300 SFM		125 - 185 SFM		85 - 160 SFM		115 - 185 SFM		85 - 115 SFM		55 - 85 SFM	
Milling Conditions												
Dia. of Mill (mm)	RPM	Feed (IPM)	RPM	Feed (IPM)	RPM	Feed (IPM)	RPM	Feed (IPM)	RPM	Feed (IPM)	RPM	Feed (IPM)
2	9,000	5.9	6,000	3.9	4,000	2.4	5,500	2.4	5,000	1.6	2,600	0.8
4	6,600	9.8	4,500	6.7	3,000	3.1	4,000	4.3	2,600	2.4	2,000	1.6
6	4,800	11.8	3,000	7.9	2,500	4.3	3,000	4.7	1,600	2.4	1,200	1.6
8	3,600	11.8	2,200	7.9	2,000	4.7	2,000	4.7	1,400	2.8	1,000	2.0
10	2,800	11.8	1,800	7.9	1,500	4.7	1,700	5.1	1,110	2.8	800	2.0
12	2,400	11.8	1,500	7.9	1,200	4.7	1,500	5.1	930	2.8	700	2.0
14	2,200	9.8	1,300	5.9	1,000	3.1	1,200	3.9	800	2.4	600	1.6
16	1,800	7.9	1,100	4.7	800	2.4	1,000	3.1	500	1.2	500	1.2

- 1) When slotting in Stainless Steels, reduce the RPM 40%, and the feed rate 60% of table values.
- 2) Use coolant when machining Stainless Steels, Nickel Alloys and Titanium Alloys.
- 3) Adjust milling condition when unusual vibration or sound occurs.

Technical Data

DRILLS

DRILLS
Cutting Condition

END MILLS

END MILLS
Cutting Condition

TAPS

TAPS
Cutting Condition

Others

Technical Data

DRILLS

DRILLS Cutting Condition

END MILLS

END MILLS Cutting Condition

TAPS

TAPS Cutting Condition

Others

Mold Meister Ball X's-mill Geo Ball **List No. 9408**
List No. 9340

Conventional Condition

Work Material	Carbon Steels Cast Irons		Alloy Steels Die Steels		Hardened Steels Pre-Hardened Steels 30-38 HRC		Stainless Steels Hardened Steels 38-45HRC		Hardened Steels 45-55HRC		
	330 - 340 SFM		310 - 320 SFM		260 - 270 SFM		225 - 230 SFM		195 - 200 SFM		
Milling Conditions											
Ball Radius (mm)	RPM	Feed (IPM)	RPM	Feed (IPM)	RPM	Feed (IPM)	RPM	Feed (IPM)	RPM	Feed (IPM)	
R 0.5	32,000	32.3	31,000	24.4	25,000	17.3	22,000	13.0	19,000	9.4	
R 1	16,000	36.2	15,000	26.8	13,000	20.1	11,000	15.0	9,600	11.0	
R 2	8,000	39.4	7,600	29.9	6,400	22.0	5,600	16.9	4,800	12.2	
R 3	5,300	39.4	5,100	30.3	4,200	21.7	3,700	16.5	3,200	12.2	
R 5	3,200	39.4	3,100	30.7	2,500	21.7	2,200	16.5	1,900	11.8	
R 8	2,000	36.2	1,900	26.8	1,600	20.1	1,400	15.0	1,200	11.0	
R10	1,600	32.3	1,500	23.6	1,300	18.1	1,100	13.0	960	9.8	
R15	1,100	29.1	1,000	20.9	850	15.4	700	11.0	640	8.7	
Depth of Cut	a _a	0.05D (R<0.5mm) 0.1D (R>=0.5mm)						0.05D			
	Pf	0.2D						0.1D			

D: Dia. of Mill
R: Ball Radius

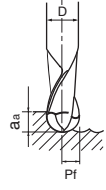

- 1) Use coolant when machining Stainless Steels, Nickel Alloys and Titanium Alloys.
- 2) When using low RPM machines, use the maximum RPM and adjust the feed rate.
- 3) Adjust milling condition when unusual vibration or sound occurs.

High Speed Condition

Work Material	Carbon Steels Cast Irons		Alloy Steels Die Steels		Hardened Steels Pre-Hardened Steels 30-38 HRC		Stainless Steels Hardened Steels 38-45HRC		Hardened Steels 45-55HRC		
	620 - 1050 SFM		620 - 1000 SFM		620 - 830 SFM		620 - 760 SFM		620 - 740 SFM		
Milling Conditions											
Ball Radius (mm)	RPM	Feed (IPM)	RPM	Feed (IPM)	RPM	Feed (IPM)	RPM	Feed (IPM)	RPM	Feed (IPM)	
R 0.5	60,000	141.7	60,000	141.7	60,000	118.1	60,000	118.1	60,000	94.5	
R 1	51,000	200.8	48,000	189.0	40,000	126.0	37,000	118.1	35,000	82.7	
R 2	25,000	196.9	24,000	189.0	20,000	126.0	18,000	98.4	18,000	86.6	
R 3	17,000	161.4	16,000	149.6	13,000	114.2	12,000	86.6	12,000	74.8	
R 5	10,200	122.0	9,600	98.4	8,000	74.8	7,300	59.1	7,000	55.1	
R 8	6,400	74.8	6,000	70.9	5,000	47.2	4,600	39.4	4,400	35.4	
R 10	5,100	63.0	4,800	55.1	4,000	39.4	3,700	35.0	3,500	27.6	
R 15	3,400	43.3	3,200	37.8	2,700	25.6	2,400	23.6	2,300	18.1	
Depth of Cut	a _a	0.05D (R<0.5mm) 0.5mm (R>=0.5mm)									
	Pf	0.1D						0.05D			

D: Dia. of Mill
R: Ball Radius

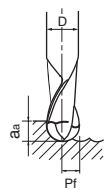

- 1) Use coolant when machining Stainless Steels, Nickel Alloys and Titanium Alloys.
- 2) When using low RPM machines, use the maximum RPM and adjust the feed rate.
- 3) Adjust milling condition when unusual vibration or sound occurs.

X's-mill Geo Micro Ball List No. 9332

Conventional Condition

Work Material	Carbon Steels Cast Irons		Alloy Steels Die Steels		Hardened Steels Pre-Hardened Steels 30~38 HRC		Stainless Steels Hardened Steels 38~45HRC		Hardened Steels 45~55HRC		
	330 - 660 SFM		330 - 580 SFM		330 - 520 SFM		330 - 455 SFM		330 - 395 SFM		
Milling Conditions	RPM	Feed (IPM)	RPM	Feed (IPM)	RPM	Feed (IPM)	RPM	Feed (IPM)	RPM	Feed (IPM)	
Ball Radius (mm)											
R 0.1	32,000	12.6	32,000	12.6	32,000	11.8	32,000	9.8	32,000	6.3	
R 0.15	32,000	18.9	32,000	18.9	32,000	17.7	32,000	14.8	32,000	9.4	
R 0.2	32,000	23.6	32,000	23.6	32,000	20.5	32,000	19.7	32,000	12.6	
R 0.25	32,000	29.5	32,000	25.6	32,000	24.4	32,000	23.6	32,000	15.7	
R 0.3	32,000	35.4	32,000	29.5	32,000	27.6	32,000	25.2	32,000	18.9	
R 0.4	32,000	47.2	32,000	39.4	32,000	36.2	32,000	33.5	32,000	25.2	
R 0.5	32,000	59.1	32,000	49.2	32,000	45.3	32,000	39.4	32,000	31.5	
R 0.75	32,000	86.6	32,000	63.0	32,000	66.9	29,500	55.1	25,500	37.4	
R 1	32,000	114.2	28,500	82.7	25,000	70.9	22,000	55.1	19,000	37.4	
R 1.5	21,000	114.2	19,000	82.7	17,000	70.9	14,500	55.1	12,500	37.4	
R 2	16,000	114.2	14,000	82.7	12,500	70.9	11,000	55.1	9,500	37.4	
Depth of Cut	a _a	0.05D (R<0.5mm) 0.1D (R>=0.5)								0.05D	
	Pf	0.2D								0.1D	

D: Dia. of Mill
R: Ball Radius

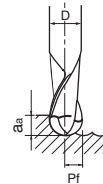

- 1) Use coolant when machining Stainless Steels, Nickel Alloys and Titanium Alloys.
- 2) When using low RPM machines, use the maximum RPM and adjust the feed rate.
- 3) Adjust milling condition when unusual vibration or sound occurs.

High Speed Condition

Work Material	Carbon Steels Cast Irons		Alloy Steels Die Steels		Hardened Steels Pre-Hardened Steels 30~38 HRC		Stainless Steels Hardened Steels 38~45HRC		Hardened Steels 45~55HRC		
	620 - 990 SFM		620 - 900 SFM		620 - 850 SFM		620 - 780 SFM		495 - 660 SFM		
Milling Conditions	RPM	Feed (IPM)	RPM	Feed (IPM)	RPM	Feed (IPM)	RPM	Feed (IPM)	RPM	Feed (IPM)	
Ball Radius (mm)											
R 0.1	60,000	23.6	60,000	23.6	60,000	22.0	60,000	18.9	48,000	9.4	
R 0.15	60,000	35.4	60,000	35.4	60,000	33.1	60,000	27.6	48,000	14.2	
R 0.2	60,000	43.3	60,000	43.3	60,000	39.4	60,000	37.0	48,000	18.9	
R 0.25	60,000	47.2	60,000	47.2	60,000	45.3	60,000	43.3	48,000	23.6	
R 0.3	60,000	55.1	60,000	55.1	60,000	51.2	60,000	47.2	48,000	28.3	
R 0.4	60,000	74.8	60,000	74.8	60,000	66.9	60,000	63.0	48,000	37.8	
R 0.5	60,000	92.5	60,000	92.5	60,000	84.6	60,000	74.8	48,000	47.2	
R 0.75	60,000	118.1	60,000	118.1	55,000	114.2	51,000	94.5	42,500	63.0	
R 1	48,000	171.3	45,000	129.9	41,500	114.2	38,000	94.5	32,000	63.0	
R 1.5	32,000	171.3	30,000	129.9	27,500	114.2	25,000	94.5	21,000	63.0	
R 2	24,000	171.3	22,000	129.9	20,500	114.2	19,000	94.5	16,000	63.0	
Depth of Cut	a _a	0.05D								0.05D	
	Pf	0.1D								0.1D	

D: Dia. of Mill
R: Ball Radius

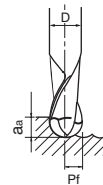

- 1) Use coolant when machining Stainless Steels, Nickel Alloys and Titanium Alloys.
- 2) When using low RPM machines, use the maximum RPM and adjust the feed rate.
- 3) Adjust milling condition when unusual vibration or sound occurs.

Technical Data

DRILLS

DRILLS
Cutting Condition

END MILLS

END MILLS
Cutting Condition

TAPS

TAPS
Cutting Condition

Others

Technical Data

X's-mill Geo KV / 2 Flute, 4 Flute List No. 9366, 9368

DRILLS

DRILLS Cutting Condition

END MILLS

END MILLS Cutting Condition

TAPS

TAPS Cutting Condition

Others

Slotting

Milling Conditions		RPM	SFM	Feed (IPM)
Dia. of Mill (mm)				
0.5		44,000	69	9.8
1.0		22,000	69	11.8
1.5		19,000	90	13.8
2.0		15,000	94	15.7
2.5		9,000	71	15.7
3.0		7,500	71	15.7
Depth of cut	H	Max 0.5D		

D: Dia. of Mill

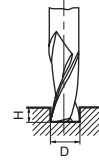

- 1) Mill using coolants.
- 2) When using low RPM machines, use the maximum RPM and adjust the feed rate.
- 3) Adjust milling condition when unusual vibration or sound occurs.

Side Milling

Milling Conditions		RPM	SFM	Feed (IPM)
Dia. of Mill (mm)				
0.5		44,000	69	14.8
1.0		22,000	69	17.7
1.5		19,000	90	20.7
2.0		15,000	94	23.6
2.5		9,000	71	23.6
3.0		7,500	71	23.6
Depth of cut	a _a	1D		
	a _r	Max 0.02D		

D: Dia. of Mill

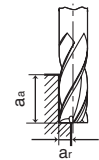

- 1) Mill using coolants.
- 2) When using low RPM machines, use the maximum RPM and adjust the feed rate.
- 3) Adjust milling condition when unusual vibration or sound occurs.

DLC-mill for Aluminum List No. 9330
DLC-mill Radius List No. 9302
DLC-mill Sharp Corner List No. 9378

Work Material		Aluminum		Aluminum Alloys						Aluminum Alloy Casting		Copper Alloys	
		1070		4032, 6061		5052		7075					
Milling Conditions		1000 - 1300 SFM		670 - 930 SFM		780 - 990 SFM		780 - 990 SFM		700 - 890 SFM		320 - 390 SFM	
Dia. of Mill (mm)		RPM	Feed (IPM)	RPM	Feed (IPM)	RPM	Feed (IPM)	RPM	Feed (IPM)	RPM	Feed (IPM)	RPM	Feed (IPM)
2		50,000	39.4	32,000	25.2	38,000	29.9	38,000	33.1	34,000	29.5	15,300	9.4
3		41,000	47.2	30,000	35.4	32,000	39.4	32,000	43.3	29,000	37.8	12,700	11.8
5		25,000	51.2	18,000	35.4	19,000	39.4	19,000	43.3	17,000	37.8	7,600	12.2
6		21,000	51.2	15,000	35.4	16,000	39.4	16,000	43.3	14,000	37.8	6,400	12.2
8		16,000	51.2	12,000	37.8	12,000	39.4	12,000	43.3	10,700	37.8	4,800	12.2
10		12,000	51.2	9,000	35.4	9,600	39.4	10,000	43.3	8,600	37.8	3,800	12.2
12		10,000	51.2	7,500	35.4	8,000	39.4	8,000	43.3	7,200	37.8	3,200	12.2
16		7,800	51.2	5,600	35.4	6,000	39.4	6,000	43.3	5,400	37.8	2,400	12.2
20		6,200	51.2	4,500	35.4	4,800	39.4	4,800	43.3	4,300	37.8	1,900	12.2
Depth of Cut	a _a	1.5D											
	a _r	0.2D										0.1D	
	H	0.5D (In dry-milling)						1D (In wet-milling)					

- 1) In case of using DLC Sharp Corner, use in Minimum Quantity of Lubrication (MQL) condition or with coolants.
- 2) When using low RPM machines, use the maximum RPM and adjust the feed rate.
- 3) When slotting, reduce the RPM 30%, and the Feed 75% of table values.
- 4) Adjust milling condition when unusual vibration or sound occurs.

D: Dia. of Mill

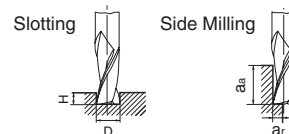

DLC-mill Slot Long Shank List No. 9390

Conventional Condition : Side Milling

Work Material		Aluminum		Aluminum Alloys						Aluminum Alloy Casting				Copper Alloys			
		1070		4032		5052		6061		7075		Si -12%		Si 12%			
Milling Conditions		970 - 1070 SFM		560 - 660 SFM		720 - 820 SFM		640 - 740 SFM		630 - 730 SFM		640 - 740 SFM		600 - 700 SFM		300 - 330 SFM	
Dia. of Mill (mm)		RPM	Feed (IPM)	RPM	Feed (IPM)	RPM	Feed (IPM)	RPM	Feed (IPM)	RPM	Feed (IPM)	RPM	Feed (IPM)	RPM	Feed (IPM)	RPM	Feed (IPM)
3		34,500	94.5	21,300	51.2	26,600	66.9	23,900	56.7	23,400	52.4	23,900	56.7	22,600	50.8	10,700	18.9
4		25,900	122.0	16,000	63.0	19,900	86.6	18,000	74.8	17,600	67.7	18,000	74.8	17,000	65.4	8,000	27.6
6		17,300	129.9	10,700	66.9	13,300	90.6	12,000	78.7	11,700	71.3	12,000	78.7	11,300	68.5	5,400	27.6
8		13,000	137.8	8,000	70.9	10,000	94.5	9,000	82.7	8,800	75.2	9,000	82.7	8,500	72.4	4,000	27.6
10		10,400	137.8	6,400	70.9	8,000	94.5	7,200	82.7	7,100	75.6	7,200	82.7	6,800	72.4	3,200	27.6
12		8,700	137.8	5,400	70.9	6,700	98.4	6,000	82.7	5,900	75.6	6,000	82.7	5,700	72.8	2,700	27.6
14		7,400	133.9	4,500	66.9	5,700	94.5	5,100	78.7	5,000	74.8	5,100	78.7	4,800	70.9	2,300	27.6
16		6,500	129.9	4,000	63.0	5,000	90.6	4,500	74.8	4,400	70.9	4,500	74.8	4,200	66.9	2,000	23.6
18		5,700	118.1	3,500	59.1	4,400	82.7	4,000	70.9	3,900	66.9	4,000	70.9	3,800	66.9	1,800	23.6
20		5,200	106.3	3,200	55.1	4,000	74.8	3,600	63.0	3,500	59.1	3,600	63.0	3,400	59.1	1,600	19.7
Depth of Cut	a _a	1.2D															
	a _r	0.2D															

Technical Data

DRILLS

DRILLS Cutting Condition

END MILLS

END MILLS Cutting Condition

TAPS

TAPS Cutting Condition

Others

Technical Data

DRILLS

DRILLS
Cutting Condition

END MILLS

END MILLS
Cutting Condition

TAPS

TAPS
Cutting Condition

Others

Conventional Condition: Slotting

Work Material	Aluminum 1070		Aluminum Alloys								Aluminum Alloy Casting			
	Milling Conditions		4032		5052		6061		7075		Si -12%		Si 12%	
	Dia. of Mill (mm)	RPM	Feed (IPM)	RPM	Feed (IPM)	RPM	Feed (IPM)	RPM	Feed (IPM)	RPM	Feed (IPM)	RPM	Feed (IPM)	
	970 - 1070 SFM	560 - 660 SFM	720 - 820 SFM	640 - 740 SFM	630 - 730 SFM	640 - 740 SFM	600 - 700 SFM							
3	34,500	82.7	21,300	43.3	26,600	59.1	23,900	48.4	23,400	44.9	23,900	48.4	22,600	43.3
4	25,900	90.6	16,000	47.2	19,900	63.0	18,000	55.1	17,600	48.8	18,000	55.1	17,000	47.2
6	17,300	94.5	10,700	47.2	13,300	66.9	12,000	55.1	11,700	50.8	12,000	55.1	11,300	49.2
8	13,000	98.4	8,000	51.2	10,000	66.9	9,000	59.1	8,800	52.8	9,000	59.1	8,500	50.8
10	10,400	98.4	6,400	51.2	8,000	66.9	7,200	59.1	7,100	53.1	7,200	59.1	6,800	50.8
12	8,700	98.4	5,400	51.2	6,700	66.9	6,000	59.1	5,900	52.8	6,000	59.1	5,700	51.2
14	7,400	94.5	4,500	47.2	5,700	66.9	5,100	55.1	5,000	51.2	5,100	55.1	4,800	51.2
16	6,500	90.6	4,000	47.2	5,000	63.0	4,500	55.1	4,400	51.2	4,500	55.1	4,200	47.2
18	5,700	86.6	3,500	43.3	4,400	59.1	4,000	51.2	3,900	47.2	4,000	51.2	3,800	47.2
20	5,200	82.7	3,200	39.4	4,000	55.1	3,600	47.2	3,500	43.3	3,600	47.2	3,400	43.3
Depth of Cut	H		1D											

D: Dia. of Mill

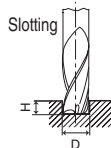
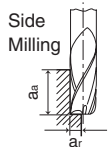

- 1) When using low RPM machines, use the maximum RPM and adjust the feed rate.
- 2) When dry milling, reduce the RPM and the Feed 30% of table values.
- 3) Adjust milling condition when unusual vibration or sound occurs.

High Speed Condition: Side Milling

Work Material	Aluminum 1070		Aluminum Alloys								Aluminum Alloy Casting				Copper Alloys	
	Milling Conditions		4032		5052		6061		7075		Si -12%		Si 12%			
	Dia. of Mill (mm)	RPM	Feed (IPM)	RPM	Feed (IPM)	RPM	Feed (IPM)	RPM	Feed (IPM)	RPM	Feed (IPM)	RPM	Feed (IPM)	RPM	Feed (IPM)	
	2000 - 2500 SFM	1200 - 1600 SFM	1500 - 2000 SFM	1300 - 1800 SFM	1300 - 1800 SFM	1300 - 1800 SFM	1000 - 1400 SFM	600 - 800 SFM								
3	62,100	204.7	38,200	102.4	47,800	145.7	43,000	121.7	42,100	113.0	43,000	121.7	33,500	89.8	19,100	40.2
4	51,800	291.3	31,900	149.6	39,800	204.7	35,900	177.2	35,100	161.4	35,900	177.2	27,900	128.3	16,000	59.1
6	38,000	338.6	23,400	173.2	29,200	236.2	26,300	204.7	25,700	187.0	26,300	204.7	20,500	149.2	11,700	66.9
8	31,100	389.8	19,100	196.9	23,900	271.7	21,500	232.3	21,100	215.4	21,500	232.3	16,800	171.7	9,600	78.7
10	24,900	389.8	15,300	196.9	19,100	271.7	17,200	232.3	16,900	215.7	17,200	232.3	13,400	171.3	7,700	78.7
12	20,700	389.8	12,800	196.9	16,000	275.6	14,400	236.2	14,100	216.1	14,400	236.2	11,200	171.7	6,400	78.7
14	17,700	385.8	10,900	192.9	13,600	271.7	12,300	232.3	12,000	212.6	12,300	232.3	9,500	169.3	5,500	74.8
16	15,500	366.1	9,500	185.0	11,900	255.9	10,700	220.5	10,500	204.7	10,700	220.5	8,400	161.4	4,800	70.9
18	12,600	318.9	7,800	161.4	9,700	224.4	8,800	192.9	8,600	177.2	8,800	192.9	6,800	141.7	3,900	63.0
20	10,300	255.9	6,400	129.9	8,000	181.1	7,200	153.5	7,000	141.7	7,200	153.5	5,600	114.2	3,200	51.2
Depth of Cut	a _a	1.2D														
	a _r	0.2D														

High Speed Condition: Slotting

Work Material	Aluminum		Aluminum Alloys								Aluminum Alloy Casting			
	1070		4032		5052		6061		7075		Si -12%		Si 12%	
	2000 - 2500 SFM		1200 - 1600 SFM		1500 - 2000 SFM		1300 - 1800 SFM		1300 - 1800 SFM		1300 - 1800 SFM		1000 - 1400 SFM	
Milling Conditions														
Dia. of Mill (mm)	RPM	Feed (IPM)	RPM	Feed (IPM)	RPM	Feed (IPM)	RPM	Feed (IPM)	RPM	Feed (IPM)	RPM	Feed (IPM)	RPM	Feed (IPM)
	3	62,100	145.7	38,200	74.8	47,800	102.4	43,000	87.0	42,100	80.7	43,000	87.0	33,500
4	51,800	177.2	31,900	90.6	39,800	126.0	35,900	106.3	35,100	97.2	35,900	106.3	27,900	77.2
6	38,000	204.7	23,400	102.4	29,200	141.7	26,300	122.0	25,700	111.8	26,300	122.0	20,500	89.0
8	31,100	228.3	19,100	114.2	23,900	161.4	21,500	137.8	21,100	126.0	21,500	137.8	16,800	100.4
10	24,900	228.3	15,300	114.2	19,100	161.4	17,200	137.8	16,900	126.0	17,200	137.8	13,400	100.0
12	20,700	228.3	12,800	118.1	16,000	161.4	14,400	137.8	14,100	126.0	14,400	137.8	11,200	100.4
14	17,700	224.4	10,900	114.2	13,600	157.5	12,300	133.9	12,000	126.0	12,300	133.9	9,500	98.4
16	15,500	220.5	9,500	110.2	11,900	153.5	10,700	129.9	10,500	122.0	10,700	129.9	8,400	98.4
18	12,600	192.9	7,800	98.4	9,700	133.9	8,800	114.2	8,600	106.3	8,800	114.2	6,800	82.7
20	10,300	161.4	6,400	82.7	8,000	114.2	7,200	98.4	7,000	90.6	7,200	98.4	5,600	70.9
Depth of Cut	H		1D											

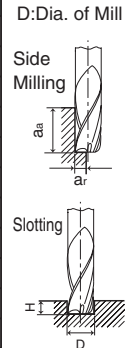

- 1) When using low RPM machines, use the maximum RPM and adjust the feed rate.
- 2) When dry milling, reduce the RPM and the Feed 30% of table values.
- 3) Adjust milling condition when unusual vibration or sound occurs.

Plunging

Work Material	Aluminum		Aluminum Alloys								Aluminum Alloy Casting			
	1070		4032		5052		6061		7075		Si -12%		Si 12%	
	970 - 1070 SFM		560 - 660 SFM		720 - 820 SFM		640 - 740 SFM		630 - 730 SFM		640 - 740 SFM		480 - 580 SFM	
Milling Conditions														
Dia. of Mill (mm)	RPM	Feed (IPM)	RPM	Feed (IPM)	RPM	Feed (IPM)	RPM	Feed (IPM)	RPM	Feed (IPM)	RPM	Feed (IPM)	RPM	Feed (IPM)
	3	34,500	39.4	21,300	19.7	26,600	27.6	23,900	21.7	23,400	20.1	23,900	21.7	18,600
4	25,900	43.3	16,000	23.6	19,900	31.5	18,000	27.6	17,600	22.8	18,000	27.6	14,000	18.1
6	17,300	43.3	10,700	23.6	13,300	31.5	12,000	27.6	11,700	24.0	12,000	27.6	9,300	18.9
8	13,000	47.2	8,000	23.6	10,000	31.5	9,000	27.6	8,800	25.2	9,000	27.6	7,000	20.1
10	10,400	47.2	6,400	23.6	8,000	31.5	7,200	27.6	7,100	25.2	7,200	27.6	5,600	20.1
12	8,700	47.2	5,400	23.6	6,700	35.4	6,000	27.6	5,900	25.2	6,000	27.6	4,700	20.1
14	7,400	43.3	4,500	23.6	5,700	31.5	5,100	27.6	5,000	23.6	5,100	27.6	4,000	19.7
16	6,500	43.3	4,000	19.7	5,000	31.5	4,500	23.6	4,400	23.6	4,500	23.6	3,500	19.7
18	5,700	39.4	3,500	19.7	4,400	27.6	4,000	23.6	3,900	23.6	4,000	23.6	3,100	19.7
20	5,200	35.4	3,200	19.7	4,000	23.6	3,600	19.7	3,500	19.7	3,600	19.7	2,800	15.7

- 1) When using low RPM machines, use the maximum RPM and adjust the feed rate.
- 2) When dry milling, reduce the RPM and feed rate by 30%. In dry plunging, reduce RPM 30% and Feed 80% of values on table above.
- 3) Adjust milling condition when unusual vibration or sound occurs.

Technical Data

DRILLS

DRILLS Cutting Condition

END MILLS

END MILLS Cutting Condition

TAPS

TAPS Cutting Condition

Others

Technical Data

DRILLS

DRILLS
Cutting Condition

END MILLS

END MILLS
Cutting Condition

TAPS

TAPS
Cutting Condition

Others

DLC-mill Ball List No. 9360

Conventional Condition

Work Material	Aluminum 1070		Aluminum Alloys						Aluminum Alloy Casting		Copper Alloys	
	Milling Conditions		4032, 6061		5052		7075					
Ball Radius (mm)	425 - 870 SFM		105 - 205 SFM		330 - 660 SFM		330 - 660 SFM		300 - 620 SFM		135 - 270 SFM	
	RPM	Feed (IPM)	RPM	Feed (IPM)	RPM	Feed (IPM)	RPM	Feed (IPM)	RPM	Feed (IPM)	RPM	Feed (IPM)
R 0.5	41,000	31.5	10,000	7.9	32,000	23.6	32,000	27.6	29,000	23.6	13,000	7.9
R 1	31,000	47.2	7,000	11.8	24,000	39.4	24,000	43.3	21,000	35.4	10,000	11.8
R 2	21,000	66.9	5,000	15.7	16,000	51.2	16,000	55.1	14,000	47.2	6,000	15.7
R 3	14,000	66.9	3,200	15.7	11,000	51.2	11,000	59.1	10,000	51.2	4,000	15.7
R 5	8,000	63.0	1,900	15.7	6,000	47.2	6,000	51.2	6,000	51.2	2,500	15.7
R 8	5,000	63.0	1,200	15.7	4,000	51.2	4,000	55.1	3,600	51.2	1,600	15.7
R 10	4,000	63.0	1,000	15.7	3,200	51.2	3,200	55.1	2,900	51.2	1,300	15.7
Depth of Cut	0.1D											
	0.2D											

- 1) When using low RPM machines, use the maximum RPM and adjust the feed rate.
- 2) In dry milling (recommended air blow), reduce the rotation and feed 30% of table values.
- 3) Adjust milling condition when unusual vibration or sound occurs.

D: Dia. of Mill
R: Ball Radius

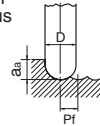

High Speed Condition

Work Material	Aluminum 1070		Aluminum Alloys						Aluminum Alloy Casting		Copper Alloys	
	Milling Conditions		4032, 6061		5052		7075					
Ball Radius (mm)	1100 - 2150 SFM		200 - 495 SFM		720 - 1650 SFM		720 - 1650 SFM		590 - 1490 SFM		260 - 680 SFM	
	RPM	Feed (IPM)	RPM	Feed (IPM)	RPM	Feed (IPM)	RPM	Feed (IPM)	RPM	Feed (IPM)	RPM	Feed (IPM)
R 0.5	62,000	47.2	19,000	15.7	60,000	47.2	60,000	51.2	57,000	51.2	25,000	15.7
R 1	54,000	86.6	14,000	23.6	48,000	74.8	48,000	82.7	43,000	74.8	19,000	23.6
R 2	47,000	149.6	11,000	35.4	36,000	114.2	36,000	126.0	32,000	110.2	14,000	35.4
R 3	34,000	161.4	8,000	39.4	27,000	126.0	27,000	141.7	24,000	126.0	11,000	39.4
R 5	21,000	165.4	4,800	39.4	16,000	126.0	16,000	137.8	14,000	122.0	6,400	39.4
R 8	13,000	165.4	3,000	39.4	9,900	126.0	9,900	137.8	9,000	126.0	4,000	39.4
R 10	10,000	157.5	2,400	39.4	8,000	126.0	8,000	137.8	7,200	126.0	3,200	39.4
Depth of Cut	0.05D											
	0.1D											

D: Dia. of Mill
R: Ball Radius

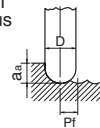

DLC-HSS mill / Inch Sizes List No. 6231HD

Work Material	Aluminum		Aluminum Alloys					
	1070		4032, 6061		5052		7075	
	960 - 980 SFM		650 - 670 SFM		820 - 825 SFM		650 - 655 SFM	
Milling Conditions								
Dia. of Mill (inch)	RPM	Feed (IPM)	RPM	Feed (IPM)	RPM	Feed (IPM)	RPM	Feed (IPM)
1/8	30,000	31.5	19,900	14.9	25,100	22.6	19,900	11.9
3/16	20,000	38.0	13,300	17.5	16,800	26.5	13,300	14.0
1/4	15,000	39.4	10,000	17.5	12,600	26.5	9,940	13.9
5/16	12,000	39.4	8,000	21.5	10,030	32.0	7,950	16.9
3/8	10,000	45.0	6,700	22.6	8,360	33.9	6,630	17.9
7/16	8,500	47.2	5,700	23.9	7,160	37.6	5,680	19.9
1/2	7,500	47.2	5,000	25.0	6,270	37.6	4,970	19.9
5/8	6,000	47.2	4,000	25.0	5,020	37.7	3,980	19.9
3/4	5,000	47.2	3,400	25.5	4,180	37.6	3,320	19.9
1	3,700	47.2	2,500	25.0	3,140	37.7	2,490	19.9
Depth of Cut	a _a	1.5D						
	a _r	0.2D						
	H	1D						

DLC-HSS mill / Metric List No. 6450

Work Material	Aluminum		Aluminum Alloys					
	1070		4032, 6061		5052		7075	
	960 - 980 SFM		650 - 670 SFM		820 - 825 SFM		650 - 655 SFM	
Milling Conditions								
Dia. of Mill (mm)	RPM	Feed (IPM)	RPM	Feed (IPM)	RPM	Feed (IPM)	RPM	Feed (IPM)
3	32,000	31.5	21,100	15.0	26,600	22.6	21,100	12.0
5	19,200	39.4	12,700	17.5	16,000	26.5	12,700	14.0
6	16,000	39.4	10,600	17.5	13,300	26.4	10,600	14.0
8	12,000	39.4	7,900	21.1	10,000	32.1	7,900	16.9
10	9,600	47.2	6,400	22.7	8,000	34.0	6,400	18.1
12	8,000	47.2	5,300	0.0	6,700	0.0	5,300	20.0
16	6,000	47.2	4,000	0.0	5,000	0.0	4,000	0.0
20	4,800	47.2	3,200	0.0	4,000	0.0	3,200	0.0
Depth of Cut	a _a	1.5D						
	a _r	0.2D						
	H	1D						

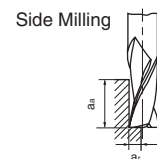
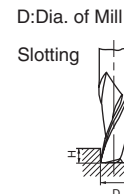

- 1) Mill using coolants.
- 2) Recommend to use List No. 9330 in milling of Aluminum Alloy Casting(A380,A390).
- 3) When slotting, reduce the RPM 40% and the Feed 60% of table values.
- 4) When using low RPM machines, use the maximum RPM and adjust the feed rate.
- 5) Adjust milling condition when unusual vibration or sound occurs.

Technical Data

DRILLS

DRILLS Cutting Condition

END MILLS

END MILLS Cutting Condition

TAPS

TAPS Cutting Condition

Others

Technical Data

DRILLS

DRILLS Cutting Condition

END MILLS

END MILLS Cutting Condition

TAPS

TAPS Cutting Condition

Others

AG-mill Roughing Short List No. 6406, 6485
AG-mill Roughing Regular Length Short List No. 6484

Work Material		Structural Steels, Carbon Steels		Alloy Steels, Pre-Hardened Steels		Mold Steels, Stainless Steels		Nickel Alloys, Titanium Alloys		Cast Irons		Aluminum Alloys, Copper Alloys, Nonferrous Alloys	
Milling Conditions		120 - 130 SFM		90 - 100 SFM		70 - 80 SFM		60 - 65 SFM		145 - 150 SFM		280 - 285 SFM	
Dia. Of Mill		RPM	Feed (IPM)	RPM	Feed (IPM)	RPM	Feed (IPM)	RPM	Feed (IPM)	RPM	Feed (IPM)	RPM	Feed (IPM)
inch	Metric mm												
-	6	2,000	10.2	1,500	7.1	1,200	3.9	1,000	3.0	2,400	12.6	4,500	47.2
1/4	6.35	1,900	10.4	1,400	7.3	1,100	4.0	950	3.1	2,200	12.6	4,300	48.3
5/16	7.938	1,500	11.0	1,200	7.5	1,000	4.6	720	3.1	1,800	13.3	3,400	51.3
-	8	1,500	11.0	1,200	7.5	1,000	4.7	720	3.1	1,800	13.4	3,400	51.2
3/8	9.525	1,300	11.0	1,000	7.6	760	4.6	630	3.2	1,500	13.5	2,900	51.7
-	10	1,200	11.0	900	7.5	720	4.7	590	3.1	1,400	13.4	2,700	51.2
-	12	1,000	11.0	800	7.5	600	4.7	490	3.3	1,200	13.4	2,300	51.2
1/2	12.7	950	11.0	720	7.6	570	4.7	470	3.3	1,100	13.5	2,200	51.7
-	15	800	11.0	610	7.5	480	4.7	400	3.3	950	13.4	1,800	51.2
5/8	15.875	760	11.0	570	7.5	460	4.7	380	3.3	900	13.5	1,700	51.3
3/4	19.05	630	11.0	480	7.5	380	4.5	320	3.3	750	13.5	1,400	50.8
-	20	600	11.0	450	7.1	360	4.3	290	3.1	720	13.4	1,400	51.2
7/8	22.225	540	11.8	410	8.6	330	5.3	270	3.6	640	16.3	1,200	59.2
-	25	480	11.4	360	7.9	290	5.1	250	3.4	550	15.4	1,100	55.1
1	25.4	470	11.4	360	7.9	290	5.0	240	3.2	560	15.7	1,100	54.4
-	30	400	10.2	300	7.1	240	4.3	200	3.1	470	14.2	900	51.2
1 1/4	31.75	380	11.4	290	7.7	230	4.8	190	3.5	450	15.2	860	55.6
1 1/2	38.1	320	8.0	240	4.7	190	3.4	160	2.6	370	10.1	720	38.8
-	40	300	6.7	250	4.3	180	2.9	150	2.0	360	9.1	670	33.1
-	50	240	4.3	180	2.8	140	1.8	120	1.3	290	5.9	550	20.5
2	50.8	240	5.3	180	3.7	140	2.5	120	1.7	280	7.2	540	25.9

- 1) In dry milling which is recommended air blow, reduce the RPM and feed to 70% of above table values.
- 2) Adjust milling condition when unusual vibration or different sound occur.

AG-mill Roughing Medium List No. 6486

Work Material		Structural Steels, Carbon Steels		Alloy Steels, Pre-Hardened Steels		Mold Steels, Stainless Steels		Nickel Alloys, Titanium Alloys		Cast Irons		Aluminum Alloys, Copper Alloys, Nonferrous Alloys	
Speed (SFM)		120 - 130 SFM		90 - 100 SFM		70 - 80 SFM		60 - 65 SFM		145 - 150 SFM		280 - 285 SFM	
Milling Conditions		RPM	Feed (IPM)	RPM	Feed (IPM)	RPM	Feed (IPM)	RPM	Feed (IPM)	RPM	Feed (IPM)	RPM	Feed (IPM)
Dia. of Mill(mm)													
6		2,100	7.1	1,600	4.7	1,300	3.0	1,100	2.0	2,400	8.7	4,500	31.5
8		1,600	7.9	1,200	5.1	1,000	3.1	800	2.2	1,800	9.4	3,400	35.4
10		1,300	7.9	960	5.1	800	3.1	640	2.3	1,400	9.4	2,700	35.4
12		1,100	7.9	800	5.1	660	3.4	530	2.3	1,200	9.4	2,300	36.2
15		850	7.9	640	5.1	530	3.4	420	2.3	960	9.4	1,800	36.2
20		640	7.1	480	4.7	400	3.2	320	2.2	720	9.4	1,400	35.0
25		510	7.5	380	5.1	320	3.3	250	2.3	570	10.2	1,100	37.4
30		420	6.7	320	4.7	270	3.0	210	2.0	480	9.4	900	33.9
40		320	4.3	240	3.0	200	1.9	160	1.3	360	5.9	680	22.0
50		250	2.8	190	1.9	160	1.2	130	0.8	290	3.9	540	13.8

AG-mill Roughing Long List No. 6488

6		2,100	5.1	1,600	2.5	1,300	1.4	1,100	1.0	2,400	5.1	4,500	20.9
8		1,600	5.9	1,200	2.5	1,000	1.4	800	1.0	1,800	5.1	3,400	20.9
10		1,300	5.9	960	2.6	800	1.4	640	1.0	1,400	5.5	2,700	21.7
12		1,100	5.9	800	2.5	660	1.4	530	1.0	1,200	5.1	2,300	21.3
15		850	5.9	640	2.5	530	1.4	420	1.0	960	5.1	1,800	21.3
20		640	5.5	480	2.4	400	1.3	320	0.9	720	5.1	1,400	20.5
25		510	5.9	380	2.2	320	1.3	250	0.9	570	5.1	1,100	19.7
30		420	5.1	320	2.0	270	1.1	210	0.8	480	4.7	900	18.1
40		320	3.3	240	1.3	200	0.7	160	0.5	360	3.0	680	11.8
50		250	2.1	190	0.9	160	0.5	130	0.4	290	2.1	540	7.9

- 1) In dry milling which is recommended air blow, reduce the RPM and feed to 70% of above table values.
- 2) Adjust milling condition when unusual vibration or different sound occur.

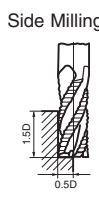
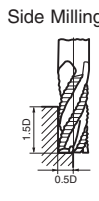
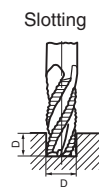
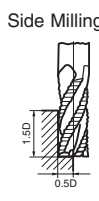
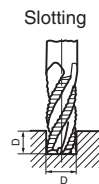

AG-mill Heavy List No. 6402, 6403

Work Material		Structural Steels, Carbon Steels		Alloy Steels, Pre-Hardened Steels		Mold Steels, Stainless Steels		Nickel Alloys, Titanium Alloys		Cast Irons		Aluminum Alloys, Copper Alloys, Nonferrous Alloys	
Milling Conditions		150 - 155 SFM		115 - 125 SFM		95 - 105 SFM		75 - 80 SFM		175 - 185 SFM		330 - 350 SFM	
Dia. Of Mill													
inch	Metric mm	RPM	Feed (IPM)	RPM	Feed (IPM)	RPM	Feed (IPM)	RPM	Feed (IPM)	RPM	Feed (IPM)	RPM	Feed (IPM)
-	3	5,000	11.4	3,800	7.5	3,200	5.1	2,500	3.5	5,800	30.3	10,800	52.0
-	5	3,000	11.4	2,300	7.5	1,900	5.1	1,600	3.5	3,500	30.3	6,500	52.0
-	6	2,500	11.4	1,900	7.5	1,600	5.1	1,300	3.5	2,900	31.1	5,400	52.0
1/4	6.35	2,300	11.2	1,800	7.7	1,500	5.2	1,200	3.3	2,800	31.1	5,200	53.0
5/16	7.938	1,900	11.5	1,400	7.6	1,200	5.1	1,000	3.5	2,200	31.0	4,100	52.2
-	8	1,900	11.4	1,400	7.5	1,200	5.1	1,000	3.5	2,200	31.1	4,100	52.0
3/8	9.525	1,600	11.5	1,200	7.7	1,000	4.9	790	3.3	1,800	31.6	3,500	53.0
-	10	1,500	11.8	1,200	7.9	1,000	5.1	800	3.5	1,700	31.5	3,200	52.0
-	12	1,300	11.4	1,000	7.9	800	5.1	600	3.5	1,400	31.1	2,800	52.0
1/2	12.7	1,200	11.2	920	7.7	760	5.3	600	3.6	1,400	31.6	2,600	51.9
-	15	1,000	11.4	800	7.9	600	5.1	500	3.5	1,200	31.1	2,200	52.0
5/8	15.875	940	11.2	730	7.7	610	5.3	480	3.5	1,100	30.0	2,100	52.0
3/4	19.05	780	10.5	610	7.7	510	4.7	400	3.1	920	28.9	1,700	52.0
-	20	750	10.2	600	7.9	500	4.7	400	3.1	900	29.1	1,700	52.0
7/8	22.225	670	9.4	520	7.0	440	4.0	340	2.6	790	26.1	1,500	46.7
-	25	600	8.7	500	5.9	400	3.5	300	2.4	700	22.8	1,300	38.6
1	25.4	580	10.5	460	6.3	380	4.1	300	2.7	690	26.8	1,300	46.0
-	30	500	7.9	400	4.7	300	3.1	250	2.0	600	20.1	1,100	33.9
1 1/4	31.75	470	7.4	370	4.4	310	3.2	240	2.5	550	16.9	1,000	29.6
1 1/2	38.1	390	7.0	310	4.1	260	3.2	200	2.1	460	10.3	870	18.7
-	40	370	6.7	300	4.3	220	2.9	180	2.0	450	9.1	800	15.5
-	50	300	4.3	240	2.8	160	1.8	120	1.3	320	5.9	620	10.5
2	50.8	290	5.1	230	3.3	150	2.2	120	1.5	310	7.3	610	13.7

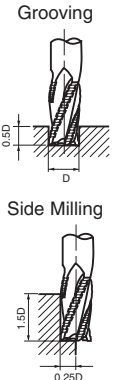

- 1) In dry milling which is recommended air blow, reduce the RPM and feed to 70% of above table values.
- 2) Adjust milling condition when unusual vibration or different sound occur.

AG-mill Heavy Long List No. 6404

Work Material		Structural Steels, Carbon Steels		Alloy Steels, Pre-Hardened Steels		Mold Steels, Stainless Steels		Nickel Alloys, Titanium Alloys		Cast Irons		Aluminum Alloys, Copper Alloys, Nonferrous Alloys	
Speed (SFM)		150 - 155 SFM		115 - 125 SFM		95 - 105 SFM		75 - 80 SFM		175 - 185 SFM		330 - 350 SFM	
Milling Conditions													
Dia. of Mill(mm)		RPM	Feed (IPM)	RPM	Feed (IPM)	RPM	Feed (IPM)	RPM	Feed (IPM)	RPM	Feed (IPM)	RPM	Feed (IPM)
3	5,000	7.1	3,800	4.7	3,200	3.1	2,500	2.0	5,800	18.5	10,800	33.1	
5	3,000	7.1	2,300	4.7	1,900	3.1	1,600	2.0	3,500	18.5	6,500	33.1	
6	2,500	7.1	1,900	4.7	1,600	3.1	1,300	2.0	2,900	18.9	5,400	33.1	
8	1,900	7.1	1,400	4.7	1,200	3.1	1,000	2.0	2,200	18.9	4,100	33.1	
10	1,500	7.1	1,200	4.7	1,000	3.1	800	2.0	1,700	19.3	3,200	33.1	
12	1,250	7.1	1,000	4.7	800	3.1	600	2.0	1,400	18.9	2,800	33.1	
15	1,000	7.1	800	4.7	600	3.1	500	2.0	1,200	18.9	2,200	31.5	
20	750	6.3	600	4.3	500	2.8	400	2.0	900	18.1	1,700	27.6	
25	600	5.5	500	3.9	400	2.4	300	1.6	700	13.8	1,300	23.6	
30	500	4.7	400	3.5	300	2.4	250	1.6	600	11.8	1,100	22.0	

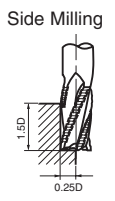

- 1) In dry milling which is recommended air blow, reduce the RPM and feed to 70% of above table values.
- 2) Adjust milling condition when unusual vibration or different sound occur.

Technical Data

DRILLS

DRILLS Cutting Condition

END MILLS

END MILLS Cutting Condition

TAPS

TAPS Cutting Condition

Others

STANDARD MILLING CONDITION

Genac Endmills 2 Flute Single End Regular Long List No. 9261X
List No. 9265X

Work Material Milling Conditions Dia. of Mill (inch)	Carbon Steels (up to 30HRc)		Alloy Steels 30~45HRc		Tool Steels 45~55HRC		Cast Iron (up to 200HB)		Cast Iron (200HB~)		Stainless Steels		Titanium Alloys		Aluminum, Nonferrous Metals	
	200 SFM		150 SFM		100 SFM		220 SFM		160 SFM		140 SFM		140 SFM		590 SFM	
	RPM	Feed (IPM)	RPM	Feed (IPM)	RPM	Feed (IPM)	RPM	Feed (IPM)	RPM	Feed (IPM)	RPM	Feed (IPM)	RPM	Feed (IPM)	RPM	Feed (IPM)
1/8	6,110	9.8	4,580	4.6	3,060	3.1	6,720	16.1	4,890	4.9	4,280	5.1	4,280	4.3	18,300	25.6
3/16	4,070	8.1	3,060	3.7	2,040	2.4	4,480	13.4	3,260	3.9	2,850	4.0	2,850	3.4	12,200	19.5
1/4	3,060	7.3	2,290	3.2	1,530	2.1	3,360	12.1	2,450	3.4	2,140	3.4	2,140	3.0	9,100	16.4
5/16	2,440	6.3	1,820	2.9	1,220	2.0	2,690	11.8	1,960	3.1	1,700	3.1	1,700	2.7	7,300	14.6
3/8	2,030	6.1	1,540	2.8	1,020	1.8	2,240	11.2	1,620	2.9	1,420	2.8	1,420	2.6	6,100	13.4
7/16	1,740	6.3	1,300	2.6	870	1.7	1,920	10.8	1,400	2.8	1,220	2.7	1,220	2.4	5,200	12.5
1/2	1,530	6.1	1,150	2.3	760	1.5	1,680	10.1	1,220	2.7	1,070	2.6	1,070	2.4	4,500	11.7
5/8	1,220	5.9	910	2.0	610	1.3	1,350	9.5	980	2.4	850	2.4	850	2.0	3,600	10.8
3/4	1,010	5.3	770	1.8	510	1.2	1,120	9.0	810	2.1	710	2.1	710	2.0	3,000	9.6
1	760	4.6	650	2.0	380	1.1	840	7.6	610	1.8	530	1.6	530	1.6	2,200	8.8
Depth of Cut	a _a	1.5D (Long 2.0D)											1.0D (Long 2.0D)		1.5D (Long 2.0D)	
	a _r	0.1D (Long 0.05D)			0.05D (Long 0.02D)			0.1D (Long 0.05D)			0.1D (Long 0.05D)		0.05D (Long 0.2D)		0.2D (Long 0.1D)	
	H	0.5D			0.3D			0.5D			0.3D		0.1D		0.5D	

Genac Endmills 4 Flute Single End Regular Long List No. 9263X
List No. 9267X

Work Material Milling Conditions Dia. of Mill (inch)	Carbon Steels (up to 30HRc)		Alloy Steels 30~45HRc		Tool Steels 45~55HRC		Cast Iron (up to 200HB)		Cast Iron (200HB~)		Stainless Steels		Titanium Alloys		Aluminum, Nonferrous Metals	
	200 SFM		150 SFM		100 SFM		220 SFM		160 SFM		140 SFM		140 SFM		590 SFM	
	RPM	Feed (IPM)	RPM	Feed (IPM)	RPM	Feed (IPM)	RPM	Feed (IPM)	RPM	Feed (IPM)	RPM	Feed (IPM)	RPM	Feed (IPM)	RPM	Feed (IPM)
1/8	6,110	19.6	4,580	9.2	3,060	6.1	6,720	32.3	4,890	9.8	4,280	10.3	4,280	8.6	18,300	51.2
3/16	4,070	16.3	3,060	7.3	2,040	4.9	4,480	26.9	3,260	7.8	2,850	8.0	2,850	6.8	12,200	39.0
1/4	3,060	14.7	2,290	6.4	1,530	4.3	3,360	24.2	2,450	6.9	2,140	6.8	2,140	6.0	9,100	32.8
5/16	2,440	12.7	1,820	5.8	1,220	3.9	2,690	23.7	1,960	6.3	1,700	6.1	1,700	5.4	7,300	29.2
3/8	2,030	12.2	1,540	5.5	1,020	3.7	2,240	22.4	1,620	5.8	1,420	5.7	1,420	5.1	6,100	26.8
7/16	1,740	12.5	1,300	5.2	870	3.5	1,920	21.5	1,400	5.6	1,220	5.4	1,220	4.9	5,200	25.0
1/2	1,530	12.2	1,150	4.6	760	3.0	1,680	20.2	1,220	5.4	1,070	5.1	1,070	4.7	4,500	23.4
5/8	1,220	11.7	910	4.0	610	2.7	1,350	18.9	980	4.7	850	4.8	850	4.1	3,600	21.6
3/4	1,010	10.5	770	3.7	510	2.4	1,120	17.9	810	4.2	710	4.3	710	4.0	3,000	19.2
1	760	9.1	650	3.9	380	2.3	840	15.1	610	3.7	530	3.2	530	3.2	2,200	17.6
Depth of Cut	a _a	1.5D (Long 2.0D)											1.0D (Long 2.0D)		1.5D (Long 2.0D)	
	a _r	0.1D (Long 0.05D)			0.05D (Long 0.02D)			0.1D (Long 0.05D)			0.1D (Long 0.05D)		0.05D (Long 0.2D)		0.2D (Long 0.1D)	
	H	0.25D			0.15D			0.25D			0.15D		0.05D		0.25D	

- 1) Mill using coolants.
- 2) Adjust milling condition when unusual vibration or sound occurs.

D: Dia. of Mill

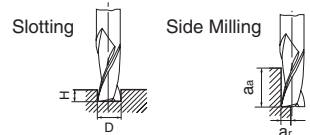

Technical Data
DRILLS
DRILLS Cutting Condition
END MILLS
END MILLS Cutting Condition
TAPS
TAPS Cutting Condition
Others

Genac Endmills 2 Flute Ball Nose Regular List No. 9271X
Long List No. 9275X

Work Material	Carbon Steels (up to 30HRc)		Alloy Steels 30~45HRc		Tool Steels 45~55HRC		Cast Iron (up to 200HB)		Cast Iron (200HB~)		Stainless Steels		Titanium Alloys		Aluminum, Nonferrous Metals	
	200 SFM		150 SFM		100 SFM		220 SFM		160 SFM		140 SFM		140 SFM		590 SFM	
	RPM	Feed (IPM)	RPM	Feed (IPM)	RPM	Feed (IPM)	RPM	Feed (IPM)	RPM	Feed (IPM)	RPM	Feed (IPM)	RPM	Feed (IPM)	RPM	Feed (IPM)
1/8	6,110	11.7	4,580	5.5	3,060	3.7	6,720	19.4	4,890	5.9	4,280	6.2	4,280	5.1	18,300	30.7
3/16	4,070	9.8	3,060	4.4	2,040	2.9	4,480	16.1	3,260	4.7	2,850	4.8	2,850	4.1	12,200	23.4
1/4	3,060	8.8	2,290	3.8	1,530	2.6	3,360	14.5	2,450	4.1	2,140	4.1	2,140	3.6	9,100	19.7
5/16	2,440	7.6	1,820	3.5	1,220	2.3	2,690	14.2	1,960	3.8	1,700	3.7	1,700	3.3	7,300	17.5
3/8	2,030	7.3	1,540	3.3	1,020	2.2	2,240	13.4	1,620	3.5	1,420	3.4	1,420	3.1	6,100	16.1
7/16	1,740	7.5	1,300	3.1	870	2.1	1,920	12.9	1,400	3.4	1,220	3.2	1,220	2.9	5,200	15.0
1/2	1,530	7.3	1,150	2.8	760	1.8	1,680	12.1	1,220	3.2	1,070	3.1	1,070	2.8	4,500	14.0
5/8	1,220	7.0	910	2.4	610	1.6	1,350	11.3	980	2.8	850	2.9	850	2.4	3,600	13.0
3/4	1,010	6.3	770	2.2	510	1.5	1,120	10.8	810	2.5	710	2.6	710	2.4	3,000	11.5
1	760	5.5	650	2.3	380	1.4	840	9.1	610	2.2	530	1.9	530	1.9	2,200	10.6
Depth of Cut	a _a	0.1D		0.05D		0.1D		0.1D		0.05D		0.1D				
	Pf	0.2D		0.1D		0.2D		0.2D		0.2D		0.1D				

Genac Endmills 4 Flute Ball Nose Regular List No. 9273X
Long List No. 9277X

Work Material	Carbon Steels (up to 30HRc)		Alloy Steels 30~45HRc		Tool Steels 45~55HRC		Cast Iron (up to 200HB)		Cast Iron (200HB~)		Stainless Steels		Titanium Alloys		Aluminum, Nonferrous Metals	
	200 SFM		150 SFM		100 SFM		220 SFM		160 SFM		140 SFM		140 SFM		590 SFM	
	RPM	Feed (IPM)	RPM	Feed (IPM)	RPM	Feed (IPM)	RPM	Feed (IPM)	RPM	Feed (IPM)	RPM	Feed (IPM)	RPM	Feed (IPM)	RPM	Feed (IPM)
1/8	6,110	19.6	4,580	9.2	3,060	6.1	6,720	32.3	4,890	9.8	4,280	10.3	4,280	8.6	18,300	51.2
3/16	4,070	16.3	3,060	7.3	2,040	4.9	4,480	26.9	3,260	7.8	2,850	8.0	2,850	6.8	12,200	39.0
1/4	3,060	14.7	2,290	6.4	1,530	4.3	3,360	24.2	2,450	6.9	2,140	6.8	2,140	6.0	9,100	32.8
5/16	2,440	12.7	1,820	5.8	1,220	3.9	2,690	23.7	1,960	6.3	1,700	6.1	1,700	5.4	7,300	29.2
3/8	2,030	12.2	1,540	5.5	1,020	3.7	2,240	22.4	1,620	5.8	1,420	5.7	1,420	5.1	6,100	26.8
7/16	1,740	12.5	1,300	5.2	870	3.5	1,920	21.5	1,400	5.6	1,220	5.4	1,220	4.9	5,200	25.0
1/2	1,530	12.2	1,150	4.6	760	3.0	1,680	20.2	1,220	5.4	1,070	5.1	1,070	4.7	4,500	23.4
5/8	1,220	11.7	910	4.0	610	2.7	1,350	18.9	980	4.7	850	4.8	850	4.1	3,600	21.6
3/4	1,010	10.5	770	3.7	510	2.4	1,120	17.9	810	4.2	710	4.3	710	4.0	3,000	19.2
1	760	9.1	650	3.9	380	2.3	840	15.1	610	3.7	530	3.2	530	3.2	2,200	17.6
Depth of Cut	a _a	0.1D		0.05D		0.1D		0.1D		0.05D		0.1D				
	Pf	0.2D		0.1D		0.2D		0.2D		0.2D		0.1D				

1) Mill using coolants.

2) Adjust milling condition when unusual vibration or sound occurs.

D: Dia. of Mill
 R: Ball Radius

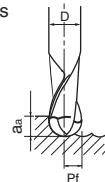

Technical
Data

DRILLS

DRILLS
Cutting
Condition

END MILLS

END MILLS
Cutting
Condition

TAPS

TAPS
Cutting
Condition

Others

Technical Data

Genac Endmills High Helix 3 Flute 60 Degrees List No. 9221X

DRILLS

DRILLS Cutting Condition

Work Material	Carbon Steels (up to 30HRc)		Alloy Steels 30~45HRc		Tool Steels 45~55HRC		Cast Iron (up to 200HB)		Cast Iron (200HB~)		Stainless Steels		Titanium Alloys		Nonferrous Metals										
	200 SFM		150 SFM		100 SFM		220 SFM		160 SFM		140 SFM		140 SFM		590 SFM										
Milling Conditions																									
Dia. of Mill (inch)	RPM	Feed (IPM)	RPM	Feed (IPM)	RPM	Feed (IPM)	RPM	Feed (IPM)	RPM	Feed (IPM)	RPM	Feed (IPM)	RPM	Feed (IPM)	RPM	Feed (IPM)									
1/8	6,110	19.1	4,580	8.9	3,060	6.0	6,720	31.4	4,890	9.5	4,280	10.0	4,280	8.3	18,300	50.0									
3/16	4,070	15.9	3,060	7.2	2,040	4.8	4,480	26.2	3,260	7.6	2,850	7.8	2,850	6.7	12,200	38.1									
1/4	3,060	14.3	2,290	6.3	1,530	4.2	3,360	23.6	2,450	6.7	2,140	6.7	2,140	5.8	9,100	31.9									
5/16	2,440	12.4	1,820	5.7	1,220	3.8	2,690	23.1	1,960	6.1	1,700	6.0	1,700	5.3	7,300	28.5									
3/8	2,030	11.9	1,540	5.4	1,020	3.6	2,240	21.8	1,620	5.7	1,420	5.5	1,420	5.0	6,100	26.2									
7/16	1,740	12.2	1,300	5.1	870	3.4	1,920	21.0	1,400	5.5	1,220	5.2	1,220	4.8	5,200	24.3									
1/2	1,530	11.9	1,150	4.5	760	3.0	1,680	19.7	1,220	5.2	1,070	5.0	1,070	4.6	4,500	22.8									
5/8	1,220	11.4	910	3.9	610	2.6	1,350	18.4	980	4.6	850	4.6	850	4.0	3,600	21.1									
3/4	1,010	10.2	770	3.6	510	2.4	1,120	17.5	810	4.1	710	4.2	710	3.9	3,000	18.7									
1	760	8.9	650	3.8	380	2.2	840	14.7	610	3.6	530	3.1	530	3.1	2,200	17.2									
Depth of Cut	a _a	1.5D																							
	a _r	0.1D				0.05D				0.1D				0.1D				0.05D				0.2D			
	H	0				0.15D				0.25D				0.15D				0.05D				0.25D			

- 1) Mill using coolants.
- 2) Adjust milling condition when unusual vibration or sound occurs.

D: Dia. of Mill

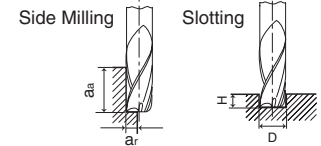

END MILLS

END MILLS Cutting Condition

Genac Endmills Roughing Center Cutting List No. 9251X

TAPS

TAPS Cutting Condition

Work Material	Carbon Steels (up to 30HRc)		Alloy Steels 30~45HRc		Tool Steels 45~55HRC		Cast Iron (up to 200HB)		Cast Iron (200HB~)		Stainless Steels		Titanium Alloys		Aluminum, Nonferrous Metals										
	200 SFM		150 SFM		100 SFM		220 SFM		160 SFM		140 SFM		140 SFM		590 SFM										
Milling Conditions																									
Dia. of Mill (inch)	RPM	Feed (IPM)	RPM	Feed (IPM)	RPM	Feed (IPM)	RPM	Feed (IPM)	RPM	Feed (IPM)	RPM	Feed (IPM)	RPM	Feed (IPM)	RPM	Feed (IPM)									
1/4	3,060	22.0	2,290	9.6	1,530	6.4	3,360	36.3	2,450	10.3	2,140	10.3	2,140	9.0	9,100	49.1									
3/8	2,030	18.3	1,540	8.3	1,020	5.5	2,240	33.6	1,620	8.7	1,420	8.5	1,420	7.7	6,100	40.3									
1/2	1,530	18.4	1,150	6.9	760	4.6	1,680	30.2	1,220	8.1	1,070	7.7	1,070	7.1	4,500	35.1									
5/8	1,220	22.0	910	7.5	610	5.0	1,350	35.4	980	8.8	850	8.9	850	7.7	3,600	40.5									
3/4	1,010	23.6	770	8.3	510	5.5	1,120	40.3	810	9.5	710	9.6	710	8.9	3,000	43.2									
1	760	20.5	650	8.8	380	5.1	840	34.0	610	8.2	530	7.2	530	7.2	2,200	39.6									
Depth of Cut	a _a	1.5D																							
	a _r	0.5D				0.2D				0.5D				0.25D				0.2D				0.5D			
	H	0.5D				0.2D				0.5D				0.5D				0.2D				0.5D			

- 1) Mill using coolants.
- 2) Adjust milling condition when unusual vibration or sound occurs.

D: Dia. of Mill

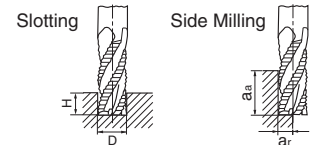

Others

SG 2-Flute End mills List No.6231X

Work Material		Carbon Steels		Alloy Steels		Die Steels Stainless Steels		Nickel Alloys Titanium Alloys		Cast Iron		Aluminum Alloys Copper Alloys Nonferrous Alloys	
		118 SFM		83 SFM		70 SFM		60 SFM		130 SFM		260 SFM	
Milling Conditions													
Dia. of Mill (inch)		RPM	Feed (IPM)	RPM	Feed (IPM)	RPM	Feed (IPM)	RPM	Feed (IPM)	RPM	Feed (IPM)	RPM	Feed (IPM)
1/8		3,600	5.5	2,600	3.5	2,100	2.2	1,800	1.7	4,000	15.2	8,000	28.0
3/16		2,400	5.5	1,700	3.5	1,400	2.2	1,200	1.6	2,700	15.1	5,300	28.0
1/4		1,800	5.5	1,300	3.5	1,100	2.2	890	1.7	2,000	15.4	4,000	28.0
3/8		1,200	5.5	840	3.6	680	2.2	600	1.7	1,400	15.7	2,700	28.3
1/2		880	5.5	630	3.6	510	2.2	450	1.7	1,000	15.4	2,000	28.3
5/8		710	5.5	510	3.5	410	2.2	360	1.7	800	15.3	1,600	28.0
3/4		590	5.5	420	3.5	340	2.1	300	1.6	670	14.8	1,400	27.2
1		440	3.9	320	2.6	260	1.6	230	1.2	500	11.0	1,000	20.5
1 1/4		360	3.0	260	2.0	210	1.3	180	0.9	400	8.3	800	15.0
1 1/2		300	2.6	210	1.6	170	1.0	150	0.8	340	6.7	700	12.6
Depth of Cut		a _s											
		1.5D											
		a _r											
0.25D													
H													
0.5D													

Technical
Data

DRILLS

DRILLS
Cutting Condition

END MILLS

END MILLS
Cutting Condition

TAPS

TAPS
Cutting Condition

Others

SG Multi-Flute End mills List No. 6211X

4 Flute

Work Material	Carbon Steels		Alloy Steels		Die Steels Stainless Steels		Nickel Alloys Titanium Alloys		Cast Iron		Aluminum Alloys Copper Alloys Nonferrous Alloys	
	118 SFM		83 SFM		70 SFM		60 SFM		130 SFM		260 SFM	
	Milling Conditions	Dia. of Mill (inch)		RPM	Feed (IPM)	RPM	Feed (IPM)	RPM	Feed (IPM)	RPM	Feed (IPM)	RPM
1/8	3,600	8.6	2,600	5.2	2,100	2.5	1,800	2.5	4,000	20.8	8,000	38.4
3/16	2,400	6.7	1,700	4.1	1,400	2.2	1,200	1.9	2,700	17.3	5,300	31.8
1/4	1,800	7.9	1,300	4.7	1,100	3.1	900	2.5	2,000	22.4	4,000	36.8
3/8	1,200	6.7	900	4.7	700	2.8	600	2.0	1,400	19.6	2,700	33.5
1/2	880	7.4	630	4.8	510	3.1	450	2.3	1,000	20.0	1,990	37.4
5/8	710	7.4	510	4.5	410	3.0	360	2.2	800	20.8	1,590	34.3
3/4	590	6.6	420	4.4	340	2.7	300	2.0	670	18.5	1,330	31.9
1	440	4.8	320	3.1	260	2.0	230	1.5	500	13.4	1,000	24.8
1 1/4	360	3.8	260	2.5	210	1.6	180	1.2	400	10.2	800	18.9
1 1/2	300	3.1	210	1.9	170	1.2	150	0.9	340	8.2	670	15.0
Depth of Cut	a _a	1.5D										
	a _r	0.25D										

6 Flute

Work Material	Carbon Steels		Alloy Steels		Die Steels Stainless Steels		Nickel Alloys Titanium Alloys		Cast Iron		Aluminum Alloys Copper Alloys Nonferrous Alloys	
	116 SFM		83 SFM		70 SFM		60 SFM		130 SFM		330 SFM	
	Milling Conditions	Dia. of Mill (inch)		RPM	Feed (IPM)	RPM	Feed (IPM)	RPM	Feed (IPM)	RPM	Feed (IPM)	RPM
1/2	880	11.1	630	7.2	510	4.6	450	3.4	1,000	30.0	2,700	56.1
5/8	710	11.1	510	6.7	410	4.4	360	3.2	800	31.2	1,990	51.5
3/4	590	9.9	420	6.6	340	4.1	300	3.1	670	27.7	1,590	47.9
1	440	7.3	320	4.7	260	3.0	230	2.3	500	20.1	1,330	37.2
1 1/4	360	5.7	260	3.7	210	2.3	180	1.7	400	15.4	1,000	28.3
1 1/2	300	4.6	210	2.9	170	1.8	150	1.4	340	12.2	800	22.5
Depth of Cut	a _a	1.5D										
	a _r	0.25D										

1) The above cutting speeds and feeds apply to regular end mill flute length.
For long fluted end mills please use the following factors below:

Cutting Length	Reduce Feed by
2.5 × Diameter	15%
3 × Diameter	25%
4 × Diameter	55%

2) In dry milling, reduce the RPM and Feed 30% of values on table above. (recommended air blow)
3) Adjust drilling condition when unusual vibration or different sound occurs.

D: Dia. of Mill

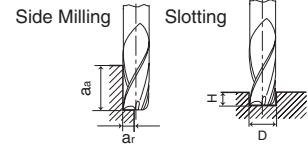

Technical Data

DRILLS

DRILLS
Cutting Condition

END MILLS

END MILLS
Cutting Condition

TAPS

TAPS
Cutting Condition

Others

SG ROUGHING AND FINISHING (HEAVY DUTY) END MILLS List No. 6367X

Work Material		Carbon Steels		Alloy Steels		Die Steels Stainless Steels		Nickel Alloys Titanium Alloys		Cast Iron		Aluminum Alloys Copper Alloys Nonferrous Alloys	
Milling Conditions		118 SFM		83 SFM		70 SFM		60 SFM		130 SFM		260 SFM	
Dia. of Mill (inch)		RPM	Feed (IPM)	RPM	Feed (IPM)	RPM	Feed (IPM)	RPM	Feed (IPM)	RPM	Feed (IPM)	RPM	Feed (IPM)
1/4		1,800	9.4	1,300	6.8	1,100	4.8	890	2.8	2,000	24.0	4,000	48.0
3/8		1,200	8.6	840	5.4	680	3.5	600	2.4	1,400	22.4	2,700	43.2
1/2		880	8.4	630	5.8	510	3.7	450	2.7	1,000	22.4	2,000	46.4
5/8		710	8.5	510	5.7	410	3.4	360	2.6	800	22.4	1,600	44.8
3/4		590	8.0	420	5.2	340	3.3	300	2.4	670	21.4	1,400	41.4
1		440	8.4	320	6.0	260	3.6	230	2.8	500	24.0	1,000	45.0
1 1/4		360	5.8	260	4.1	210	2.5	180	1.9	400	16.3	800	29.8
1 1/2		300	4.7	210	3.2	170	1.9	150	1.5	340	13.5	700	25.2
1 3/4		260	3.4	180	2.2	150	1.4	130	1.1	290	11.3	600	18.0
Depth of Cut	a _a	1.5D											
	a _r	0.25D											
	H	0.5D											

SG ROUGHING(HOG) END MILLS List No. 6303X

Work Material		Carbon Steels		Alloy Steels		Die Steels Stainless Steels		Nickel Alloys Titanium Alloys		Cast Iron		Aluminum Alloys Copper Alloys Nonferrous Alloys	
Milling Conditions		118 SFM		83 SFM		70 SFM		60 SFM		130 SFM		260 SFM	
Dia. of Mill (inch)		RPM	Feed (IPM)	RPM	Feed (IPM)	RPM	Feed (IPM)	RPM	Feed (IPM)	RPM	Feed (IPM)	RPM	Feed (IPM)
1/4		1,800	7.2	1,300	4.7	1,100	3.5	890	2.1	2,000	9.6	4,000	36.8
3/8		1,200	7.2	840	5.0	680	2.7	600	1.9	1,400	9.0	2,700	33.5
1/2		880	7.0	630	4.8	510	2.9	450	2.0	1,000	8.8	2,000	36.0
5/8		710	7.1	510	4.5	410	3.0	360	2.1	800	8.6	1,600	35.2
3/4		590	6.8	420	4.4	340	2.7	300	2.0	670	8.6	1,400	34.7
1		440	7.8	320	5.0	260	3.4	230	2.5	500	11.3	1,000	42.5
1 1/4		360	7.6	260	5.0	210	3.3	180	2.3	400	11.0	800	40.8
1 1/2		300	5.2	210	3.2	170	2.0	150	1.5	340	7.3	700	28.6
1 3/4		260	3.6	180	2.2	150	1.4	130	1.1	290	4.9	600	19.8
—		1,900	7.1	1,300	4.3	1,100	2.8	930	2.1	2,100	8.7	4,200	35.0
Depth of Cut	a _a	1.5D											
	a _r	0.25D											
	H	0.5D											

- 1) In dry milling , reduce the RPM and feed rate 30% of values on table above. (recommended air blow)
- 2) Adjust milling condition when unusual vibration or sound occurs.

D: Dia. of Mill

Slotting

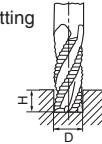

Side Milling



Technical Data

DRILLS

DRILLS
Cutting Condition

END MILLS

END MILLS
Cutting Condition

TAPS

TAPS
Cutting Condition

Others

STANDARD MILLING CONDITION

2-Flute End mills **Single End / Regular**
Single End / Regular, HSS-Co
Single End / Long
Single End / Metric Regular, HSS-Co
Double End / Regular

List No. 231
List No. 6231
List No. 6233
List No. 6230
List No. 261

Work Material		Carbon Steels		Alloy Steels		Die Steels Stainless Steels		Nickel Alloys Titanium Alloys		Cast Iron		Aluminum Alloys Copper Alloys Nonferrous Alloys	
Milling Conditions		85 SFM		60 SFM		40 SFM		33 SFM		100 SFM		200 SFM	
Dia. of Mill (inch)	(mm)	RPM	Feed (IPM)	RPM	Feed (IPM)	RPM	Feed (IPM)	RPM	Feed (IPM)	RPM	Feed (IPM)	RPM	Feed (IPM)
		—	2	4,000	3.1	2,800	2.0	2,000	1.1	1,600	0.7	4,800	9.1
—	3	2,700	3.3	1,900	2.1	1,300	1.2	1,100	0.8	3,200	9.4	6,400	17.7
1/8	3.175	2,600	3.3	1,800	2.1	1,300	1.2	1,100	0.8	3,100	9.4	6,100	17.7
3/16	4.7625	1,700	3.3	1,200	2.1	840	1.2	680	0.8	2,100	9.4	4,100	17.7
—	5	1,600	3.3	1,100	2.1	800	1.2	640	0.8	1,900	9.4	3,800	17.7
—	6	1,300	3.3	930	2.1	660	1.2	530	0.8	1,600	9.4	3,200	17.7
1/4	6.35	1,300	3.3	890	2.1	630	1.2	510	0.8	1,600	9.4	3,100	17.7
—	8	1,000	3.3	700	2.1	500	1.2	400	0.8	1,200	9.4	2,400	17.7
3/8	9.525	850	3.3	600	2.1	420	1.2	340	0.8	1,100	9.4	2,100	17.7
—	10	800	3.4	560	2.1	400	1.2	320	0.8	960	9.4	1,900	17.7
—	12	660	3.3	460	2.1	330	1.2	270	0.8	800	9.4	1,600	17.7
1/2	12.7	640	3.3	450	2.1	320	1.2	260	0.8	800	9.4	1,600	17.7
—	15	530	3.3	370	2.1	270	1.2	210	0.8	640	9.4	1,300	17.7
5/8	15.875	510	3.3	360	2.1	260	1.2	210	0.8	610	9.4	1,300	17.7
3/4	19.05	430	3.2	300	2.0	210	1.1	170	0.7	510	9.1	1,100	16.9
—	20	400	3.1	280	2.0	200	1.1	160	0.7	480	9.1	960	16.5
—	25	320	2.4	220	1.5	160	0.8	130	0.6	380	7.1	760	12.6
1	25.4	320	2.4	230	1.5	160	0.8	130	0.6	380	7.0	770	12.4
—	30	270	1.9	190	1.2	130	0.7	110	0.5	320	5.5	640	10.2
1 1/4	31.75	260	1.8	180	1.1	130	0.6	110	0.5	310	5.1	610	9.8
1 1/2	38.1	220	1.5	150	0.9	110	0.5	90	0.4	260	4.1	510	7.9
—	40	200	1.3	140	0.8	100	0.5	80	0.3	240	3.8	480	7.1
1 3/4	44.45	190	1.1	130	0.6	90	0.4	80	0.3	220	3.0	440	5.9
—	50	160	0.7	110	0.4	80	0.2	60	0.2	190	2.0	380	3.5
2	50.8	160	0.6	120	0.4	80	0.2	70	0.2	190	1.9	390	3.4
Depth of Cut		1.5D											
		0.25D											
		0.5D											

1) The above cutting speeds and feeds apply to regular end mill flute length.
 For long fluted end mills please use the following factors below:

Cutting Length	Reduce Feed by
2.5 × Diameter	15%
3 × Diameter	25%
4 × Diameter	55%
5 × Diameter	65%
6 × Diameter	75%

2) In dry milling, reduce the RPM and Feed 30% of values on table above. (recommended air blow)
 3) Adjust drilling condition when unusual vibration or different sound occurs.

D: Dia. of Mill

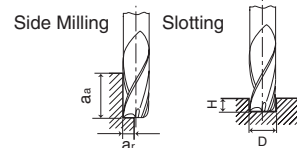

Technical Data

DRILLS

DRILLS
Cutting Condition

END MILLS

END MILLS
Cutting Condition

TAPS

TAPS
Cutting Condition

Others

4-Flute and Multi-Flute End mills

- | | | |
|---------------------------------|-----------------------------|---------------|
| Single End | Extra Long - Center Cutting | List No. 215 |
| Regular, Center Cutting | | |
| Regular, Center Cutting, HSS-Co | List No. 211 | |
| Metric Regular HSS-Co | List No. 6211M | |
| Long, Center Cutting | Double End | |
| Long, Center Cutting, HSS-Co | Regular, Center Cutting | List No. 271 |
| | | List No. 6210 |
| | | List No. 213 |
| | | List No. 6213 |

4-Flute

Work Material		Carbon Steels		Alloy Steels		Die Steels Stainless Steels		Nickel Alloys Titanium Alloys		Cast Iron		Aluminum Alloys Copper Alloys Nonferrous Alloys	
Milling Conditions		85 SFM		60 SFM		40 SFM		33 SFM		100 SFM		200 SFM	
Dia. of Mill (inch)	(mm)	RPM	Feed (IPM)	RPM	Feed (IPM)	RPM	Feed (IPM)	RPM	Feed (IPM)	RPM	Feed (IPM)	RPM	Feed (IPM)
		—	3	2,700	5.1	1,900	3.1	1,300	1.8	1,100	1.2	3,200	14.2
1/8	3.175	2,600	5.1	1,800	3.1	1,300	1.8	1,100	1.2	3,100	14.2	6,100	26.4
3/16	4.7625	1,700	5.1	1,200	3.1	840	1.7	680	1.2	2,100	14.2	4,100	26.4
—	5	1,600	5.1	1,100	3.1	800	1.7	640	1.2	1,900	14.2	3,800	25.6
—	6	1,300	5.1	930	3.1	660	1.7	530	1.2	1,600	14.2	3,200	26.4
1/4	6.35	1,300	5.1	890	3.1	630	1.7	510	1.2	1,600	14.2	3,100	26.4
—	8	1,000	5.1	700	3.1	500	1.7	400	1.2	1,200	14.2	2,400	26.4
3/8	9.525	850	5.1	600	3.1	420	1.8	340	1.2	1,100	14.4	2,100	26.6
—	10	800	5.1	560	3.2	400	1.8	320	1.2	960	14.6	1,900	26.8
—	12	660	5.1	460	3.2	330	1.8	270	1.2	800	14.6	1,600	26.4
1/2	12.7	640	5.1	450	3.2	320	1.8	260	1.2	800	14.6	1,600	26.4
—	15	530	5.1	370	3.1	270	1.8	210	1.2	640	14.6	1,300	26.4
5/8	15.875	510	5.1	360	3.1	260	1.7	210	1.2	610	14.4	1,300	25.6
3/4	19.05	430	4.9	300	3.0	210	1.7	170	1.1	510	13.6	1,100	25.2
—	20	400	4.7	280	3.0	200	1.7	160	1.1	480	13.4	960	24.8
—	25	320	3.6	220	2.3	160	1.3	130	0.9	380	10.2	760	18.9
1	25.4	320	3.5	230	2.3	160	1.3	130	0.9	380	10.0	770	18.7
—	30	270	2.9	190	1.8	130	1.0	110	0.7	320	8.3	640	15.4
1 1/4	31.75	260	2.7	180	1.7	130	1.0	110	0.7	310	7.9	610	14.2
1 1/2	38.1	220	2.2	150	1.4	110	0.8	90	0.5	260	6.1	510	11.4
—	40	200	2.0	140	1.3	100	0.7	80	0.5	240	5.5	480	10.6
1 3/4	44.45	190	1.6	130	1.0	90	0.6	80	0.4	220	4.1	440	8.7
—	50	160	1.0	110	0.6	80	0.4	60	0.2	190	2.9	380	5.5
2	50.8	160	1.0	120	0.6	80	0.3	70	0.2	190	2.8	390	5.3
Depth of Cut		a _a 1.5D											
		a _r 0.25D											

Technical
Data

DRILLS

DRILLS
Cutting
Condition

END MILLS

END MILLS
Cutting
Condition

TAPS

TAPS
Cutting
Condition

Others

Technical Data

DRILLS

DRILLS Cutting Condition

END MILLS

END MILLS Cutting Condition

TAPS

TAPS Cutting Condition

Others

6-Flute

Work Material Milling Conditions	Carbon Steels		Alloy Steels		Die Steels Stainless Steels		Nickel Alloys Titanium Alloys		Cast Iron		Aluminum Alloys Copper Alloys Nonferrous Alloys	
	85 SFM		60 SFM		40 SFM		33 SFM		100 SFM		200 SFM	
Dia. of Mill (inch)	RPM	Feed (IPM)	RPM	Feed (IPM)	RPM	Feed (IPM)	RPM	Feed (IPM)	RPM	Feed (IPM)	RPM	Feed (IPM)
1/2	640	7.7	450	4.8	320	2.7	260	1.8	800	21.9	1,600	39.6
5/8	510	7.7	360	4.6	260	2.6	210	1.8	610	21.6	1,300	38.4
3/4	430	7.4	300	4.5	210	2.5	170	1.7	510	20.4	1,100	37.8
7/8	370	6.5	260	4.0	180	2.2	150	1.5	440	17.7	900	33.1
1	320	5.3	230	3.4	160	1.9	130	1.3	380	15.1	770	28.1
1 1/4	260	4.1	180	2.6	130	1.5	110	1.0	310	11.8	610	21.3
1 1/2	220	3.2	150	2.1	110	1.2	90	0.8	260	9.2	510	17.1
2	160	1.5	120	0.9	80	0.5	70	0.3	190	4.1	390	8.0
Depth of Cut	a_a											
	a_r											
1.5D												
0.25D												

1) The above cutting speeds and feeds apply to regular end mill flute length.
For long fluted end mills please use the following factors below:

Cutting Length	Reduce Feed by
2.5 × Diameter	15%
3 × Diameter	25%
4 × Diameter	55%
5 × Diameter	65%
6 × Diameter	75%

2) In dry milling, reduce the RPM and Feed 30% of values on table above. (recommended air blow)
3) Adjust drilling condition when unusual vibration or different sound occurs.

D: Dia. of Mill

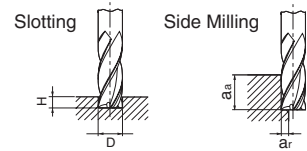

Roughing and Finishing (Heavy Duty) End Mills List No. 6367

Work Material	Carbon Steels		Alloy Steels		Die Steels Stainless Steels		Nickel Alloys Titanium Alloys		Cast Iron		Aluminum Alloys Copper Alloys Nonferrous Alloys	
	80 SFM		60 SFM		40 SFM		33 SFM		100 SFM		200 SFM	
	RPM	Feed (IPM)	RPM	Feed (IPM)	RPM	Feed (IPM)	RPM	Feed (IPM)	RPM	Feed (IPM)	RPM	Feed (IPM)
1/4	1,300	5.9	900	3.7	700	2.1	510	1.5	1,600	17.3	3,100	31.5
3/8	820	5.9	600	3.8	410	2.1	340	1.5	1,100	17.7	2,100	32.1
1/2	620	5.9	450	3.8	310	2.1	260	1.5	800	17.3	1,600	31.9
5/8	490	5.9	360	3.7	250	2.1	210	1.5	610	17.1	1,300	31.5
3/4	410	5.6	300	3.6	210	2.0	170	1.4	510	16.3	1,100	31.5
1	310	5.5	230	3.5	160	2.2	130	1.4	380	15.7	800	29.5
1 1/4	250	4.3	180	2.7	130	1.5	110	1.1	310	12.6	700	23.6
1 1/2	210	3.5	150	2.2	110	1.2	90	0.8	260	9.8	600	18.5
1 3/4	180	2.4	130	1.6	90	0.9	80	0.6	220	7.5	500	13.8
2	160	2.0	120	1.4	80	0.7	70	0.5	190	5.9	400	11.0
Depth of Cut	a _a	1.5D										
	a _r	0.25D										
	H	0.5D										

**Roughing (HOG) End Mills
Roughing (HOG) End Mills / Fine Pitch Multi Flute**

**List No. 6303
List No. 6307**

Work Material	Carbon Steels		Alloy Steels		Die Steels Stainless Steels		Nickel Alloys Titanium Alloys		Cast Iron		Aluminum Alloys Copper Alloys Nonferrous Alloys	
	80 SFM		60 SFM		40 SFM		33 SFM		100 SFM		200 SFM	
	RPM	Feed (IPM)	RPM	Feed (IPM)	RPM	Feed (IPM)	RPM	Feed (IPM)	RPM	Feed (IPM)	RPM	Feed (IPM)
1/4	1,300	5.1	900	3.1	700	1.7	510	1.2	1,600	6.7	3,100	26.4
3/8	820	5.1	600	3.1	410	1.7	340	1.2	1,100	6.7	2,100	26.4
1/2	620	5.1	450	3.2	310	1.7	260	1.2	800	6.7	1,600	26.4
5/8	490	5.1	360	3.1	250	1.7	210	1.2	610	6.7	1,300	26.4
3/4	410	5.1	300	3.0	210	1.7	170	1.2	510	6.7	1,100	26.4
1	310	5.1	230	3.1	160	1.8	130	1.2	380	6.7	800	26.4
1 1/4	250	4.9	180	3.1	130	1.8	110	1.2	310	6.7	700	26.4
1 1/2	210	3.5	150	2.3	110	1.3	90	0.9	260	5.3	600	21.7
1 3/4	180	2.6	130	1.6	90	0.9	80	0.6	220	3.7	500	15.7
2	160	2.4	120	1.6	80	0.9	70	0.6	190	3.5	400	14.2
Depth of Cut	a _a	1.5D										
	a _r	0.25D										
	H	0.5D										

1) The above cutting speeds and feeds apply to regular end mill flute length.
For long fluted end mills please use the following factors below:

Cutting Length	Reduce Feed by
2.5 × Diameter	15%
3 × Diameter	25%
4 × Diameter	55%

2) In dry milling, reduce the RPM and Feed 30% of values on table above. (recommended air blow)
3) Adjust drilling condition when unusual vibration or sound occurs.

D: Dia. of Mill

Slotting

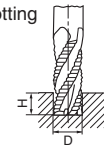

Side Milling

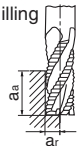

Technical Data

DRILLS

DRILLS
Cutting Condition

END MILLS

END MILLS
Cutting Condition

TAPS

TAPS
Cutting Condition

Others

Technical Data

DRILLS

DRILLS
Cutting Condition

END MILLS

END MILLS
Cutting Condition

TAPS



TAPS
Cutting Condition

Others

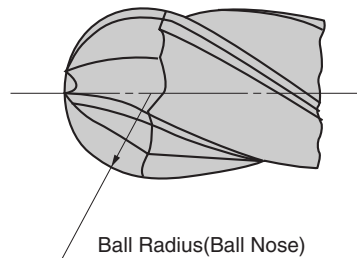
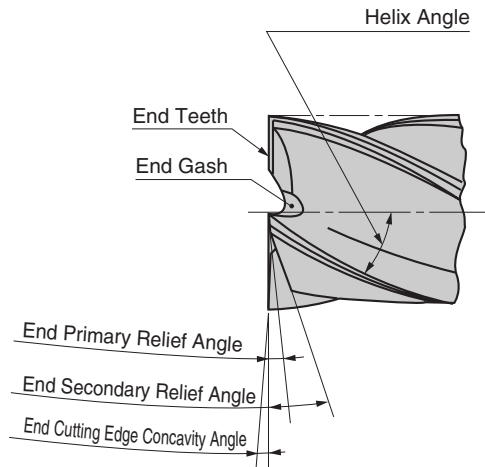
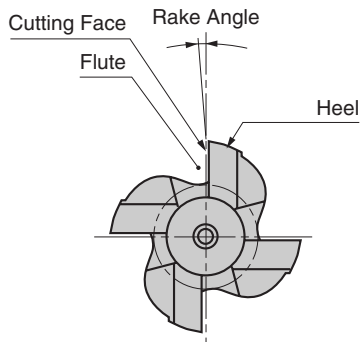
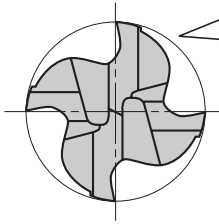
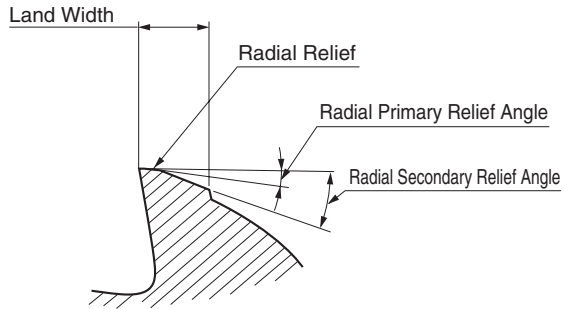
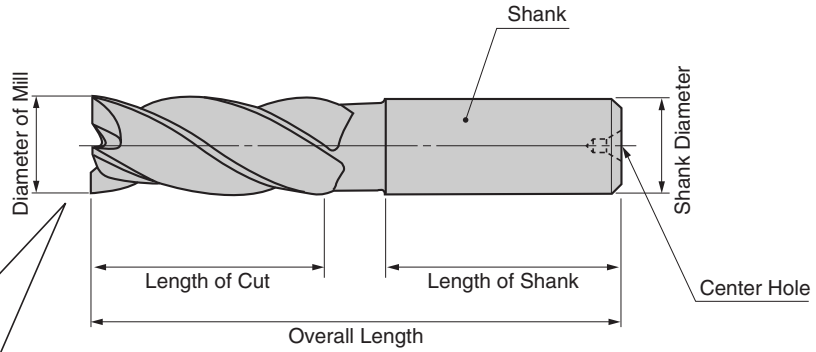

END MILL NOMENCLATURE

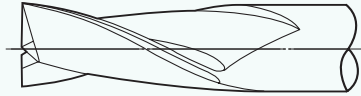
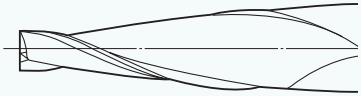

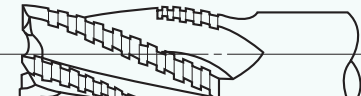
THE PERIPHERAL TEETH AND THE FEATURES

Type	Form	Features
Square type		<ul style="list-style-type: none"> Used for general purpose, that is slotting, side milling, etc. Used for every cutting. That is rough cut, semi-finish cut and finish cut.
Tapered type		<ul style="list-style-type: none"> Used for milling of draft angle of die components. The peripheral teeth is taper.
Roughing type (HOG)		<ul style="list-style-type: none"> Suitable for rough milling, because of the small cutting resistance, and small cutting chips by the wavy type nicks. Do not use for finish milling because of too much roughness.
HEAVY type (Roughing and Finishing)		The cutting resistance is larger than roughing endmill, but smaller than square teeth endmill. Suitable for semi-finish milling and the parts which not required accurate tolerance.

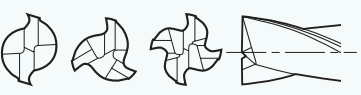
THE END TEETH TYPE AND THE FEATURE

Type	Form	Features
Square type with center hole		<ul style="list-style-type: none"> Used for general purpose, that is slotting, side milling, etc. Can not be used for plunge feed.
Square type without center hole		<ul style="list-style-type: none"> Used for general purpose, that is slotting, side milling, etc. Can be used for plunge feed. 2 Flutes is better than multi flutes for plunge cut.
Ball		<ul style="list-style-type: none"> Used for contour milling or copy milling of die components. The center of teeth does not have better cutting performance because of too small chip pocket and cutting speed.
Corner radius		<ul style="list-style-type: none"> Suitable for radius shape milling for corner of die components or machine parts. Suitable for high-speed contour milling because of its rigidity.

Technical Data

DRILLS

DRILLS Cutting Condition

END MILLS

END MILLS Cutting Condition

TAPS

TAPS Cutting Condition

Others

END MILLS / TOLERANCE OF DIAMETER

DESCRIPTION	LIST NO.	Dia. of Mill		TOLERANCE (Inch)	
		Above	Up to		
2-FLUTE SINGLE END	6230		10(mm)	0/-0.0008	
		10(mm)	30(mm)	0/-0.0010	
		30(mm)		0/-0.0012	
	6231		1/8~2(Inch)	+0.0010/0	
	6231X		1/8~1-1/2(Inch)	+0.0010/0	
	6231H		1/4~2(Inch)	+0.0030/0	
	6233		1/4~2(Inch)	+0.0010/0	
	231		1/8~2-1/2(Inch)	+0.0010/0	
	291		1/8~2(Inch)	+0.0010/0	
	6291		1/8~1-1/2(Inch)	+0.0010/0	
	6290		1.5~40.0(mm)	0/-0.0010	
	6293		1/4~1-1/4(Inch)	+0.0030/0	
2-FLUTE DOUBLE END	261		1/8~1(Inch)	0/-0.0015	
	6261		1/8~1(Inch)	0/-0.0015	
	295		1/8~1(Inch)	0/-0.0015	
	6295		1/8~1(Inch)	0/-0.0015	
4-FLUTE SINGLE END	6210		10(mm)	+0.0008/0	
		10(mm)	30(mm)	+0.0010/0	
		30(mm)		+0.0012/0	
	6213		1/4~1-1/4(Inch)	+0.0010/0	
	211		1/8~2(Inch)	+0.0010/0	
	213		1/4~2(Inch)	+0.0010/0	
	215		1/4~1-1/4(Inch)	+0.0010/0	
	6281			3/8(Inch)	0/-0.0023
		3/8(Inch)	5/8(Inch)	0/-0.0028	
		5/8(Inch)	1(Inch)	0/-0.0033	
1(Inch)			0/-0.0039		

DESCRIPTION	LIST NO.	Dia. of Mill		TOLERANCE (Inch)
		Above	Up to	
4-FLUTE DOUBLE END	6241		1/8~1(Inch)	+0.0030/0
	271		1/8~1(Inch)	0/-0.0015
	6271		1/8~1(Inch)	0/-0.0015
MULTI-FLUTE SINGLE END	6211M		1/8~2(Inch)	+0.0010/0
	6211X		1/8~1-1/2(Inch)	+0.0010/0
	6201		1/8~2(Inch)	+0.0010/0
	6203		1/4~2(Inch)	+0.0010/0
	6207		1/4~2(Inch)	+0.0010/0
	ROUGHING (HOG)	6303		1/4~2(Inch)
6303P			1/4~2(Inch)	±0.0040
6305			1/4~2(Inch)	±0.0040
6307			1/4~2(Inch)	±0.0040
6304			12.0~50.0(mm)	±0.0040
6303X			1/4~2(Inch)	±0.0040
ROUGHING AND FINISHING		6367		1/4~3(Inch)
	6367P		1/4~2(Inch)	+0.0010/0
	6367X		1/4~2(Inch)	+0.0010/0
PM-HSS HIGH HELIX	7221P		1/4~1-1/2(Inch)	+0.0010/0
GENAC"SG" 2-FLUTE SINGLE END	9261X		1/8~1(Inch)	0/-0.0020
	9265X		1/8~1(Inch)	0/-0.0020
	9271X		1/8~1(Inch)	0/-0.0020
	9275X		1/8~1(Inch)	0/-0.0020
GENAC"SG" 4-FLUTE SINGLE END	9263X		1/8~1(Inch)	0/-0.0020
	9267X		1/8~1(Inch)	0/-0.0020
	9273X		1/8~1(Inch)	0/-0.0020
	9277X		1/8~1(Inch)	0/-0.0020
GENAC"SG"ROUGHING	9251X		1/4~1-1/4(Inch)	0/-0.0020
HIGH HELIX 3-FLUTE	9221X		1/8~1(Inch)	0/-0.0020

Milling Terminology

Terms	Descriptions	Formulas
SFM	Surface Feet Per Minute	$D \times \text{RPM} \times 0.26$
RPM	Revolutions Per Minute	$\frac{\text{SFM} \times 3.82}{\text{RPM}}$
D	Cutter Diameter	

Technical Data

DRILLS

DRILLS
Cutting Condition

END MILLS

END MILLS
Cutting Condition

TAPS

TAPS
Cutting Condition

Others

1. Correct Selection of End Mills

It is necessary to choose the most suitable end mills considering cutting efficiency, accuracy and so on for high efficient machining.

Tool Material

HSS-Co (equivalent to SKH59) shows excellent performance for cutting normal steel to non-ferrous alloy and cast iron. Select coated HSS, PM-HSS, FAX or Carbide for more efficient and long lasting milling.

Number of Flutes

Generally, 2-Flute is used for slot milling because of its wide chip pocket. 4-Flute is used for side milling because of its high rigidity.

Helix Angle

Generally 30° is used because better surface finish is obtained by helix angle around 30°. Lower helix is good for keyway slotting because the slot inclination is small. The bigger is the helix, the better will be the surface finish so that the high helix end mills will be used for contour milling.

Guidance for no. of flutes selection

Functions	Characteristics	No. of Flutes	
		2-Flt	4-Flt
Strength	Twist rigidity	○	◎
	Bending rigidity	○	◎
Surface Finish	Roughness	○	◎
	Waving	○	◎
	Inclination	○	◎
Tool Life S50C(200HB)	Feed (mm/tooth) constant	○	◎
	Wear Broken	○	◎
SKD11(320HB)	Feed (mm/min.) constant	○	◎
	Wear Broken	○	◎
Chip disposal	Chip jam	○	◎
	Chip exhaust	○	◎
Resharpening	Out dia relief	◎	○
	End teeth	◎	○
Form modify	Ball nose, Taper Form	◎	○

◎ Great ○ Good

Functions	Characteristics	No. of Flutes	
		2-Flt	4-Flt
Drilling	Counter Sink	◎	○
	Surface Roughness	◎	○
	Enlargement of Holes	◎	○
Cutting	Finishing	○	◎
	Light Duty	○	◎
	Heavy Duty	○	◎
Slotting	Chip exhaust	◎	○
	Enlarge, Eccentricity	◎	○
	Keyway Cutting	◎	○
Side Milling	Milling Accuracy	○	◎
	Chattering Vibration	◎	○
Work Material	Alloy Steel	○	◎
	Cast Iron	○	◎
	Non-ferrous material	◎	○
	Difficult machining	○	◎

◎ Great ○ Good

Characteristics of end mill helix

Range of helix angle	Cutting resistance			Surface accuracy			Tool life			Resharpening	
	Torque	Bendg	Thrust	Roughness	Waving	Inclination	Flank Wear	Out dia. Downsize	Breakage	Peripheral Relief	End teeth
Low helix	○	○	●	○	●	●	○	△	○	●	●
Standard helix	●	●	○	●	○	○	●	○	●	●	●
High helix	●	●	△	●	△	○	○	●	○	○	○

● Great ○ Good △ OK –Judging from usage of end mills

HELIX ANGLE AND SURFACE ACCURACY

End mill	Speed	Feed	Material	Axial Depth	Cutg. Fluid
15S4	20.6 m/min.	0.05 mm/Tth	S50C (200HB)	35mm	Oil

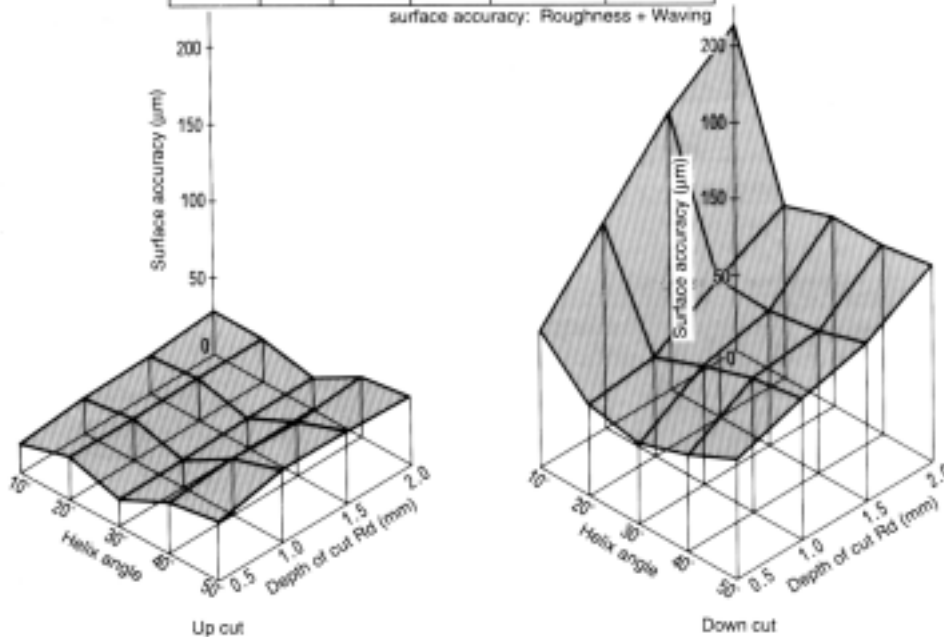

Helix angle & Surface accuracy

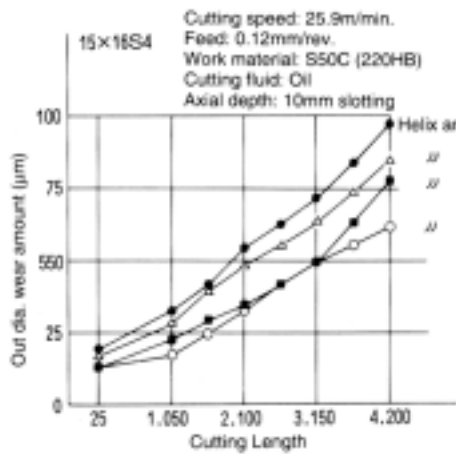

Relation between Helix angle and Out dia wear amount

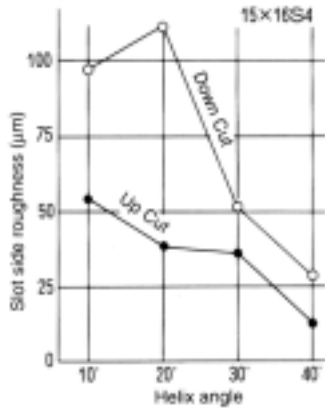

Relation between Helix angle and Slot side roughness

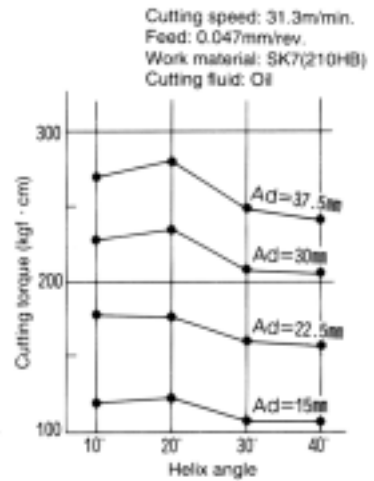

Relation between Helix angle and Cutting torque

2. Maintenance of machine and Fixture

3. Correct Holding of End Mills

It is important for the milling chuck to have the following conditions.

1. Strong chucking force
2. Accurate chucking
3. Rigid chucking
4. Easy handling
5. Excellent safety

4. Firm fixture of the work

5. Proper selection of cutting conditions

6. Proper sharpening

Technical Data

DRILLS

DRILLS
Cutting Condition

END MILLS

END MILLS
Cutting Condition

TAPS

TAPS
Cutting Condition

Others

STRENGTH COMPARISON BY FLUTE LENGTH

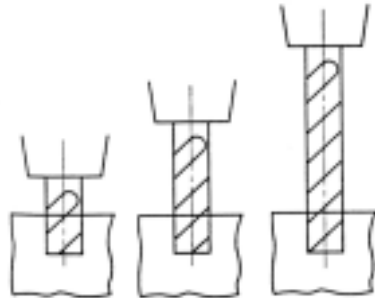

Flute length ratio	1	1.4	2.5
Strength ratio	155	19	1

The best endmill selection is as short as possible

CUTTING DIRECTION

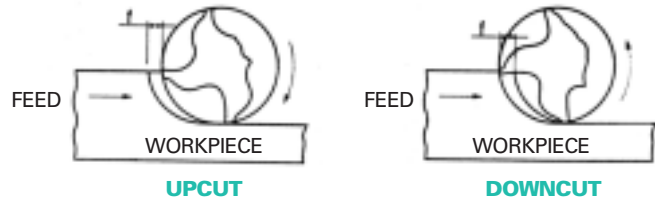

	Surface Finish	Tool Life	Application
Upcut	●		Finish
Downcut		●	Rough or Semi Finish

HEAVY'S FEATURES (Rough and Finish)

1. Nachi Heavy is designed with specially formed and disposed nicks so that it may decrease cutting resistance and minimize waviness or vibrations on the surface finish.
2. Diameter rotation generates a straight line. Therefore surface finish is excellent.
3. Chips flow out easily because of their chopped form.
4. Cutting fluid penetration is very smooth.

Example of Heavy and other end mills performances

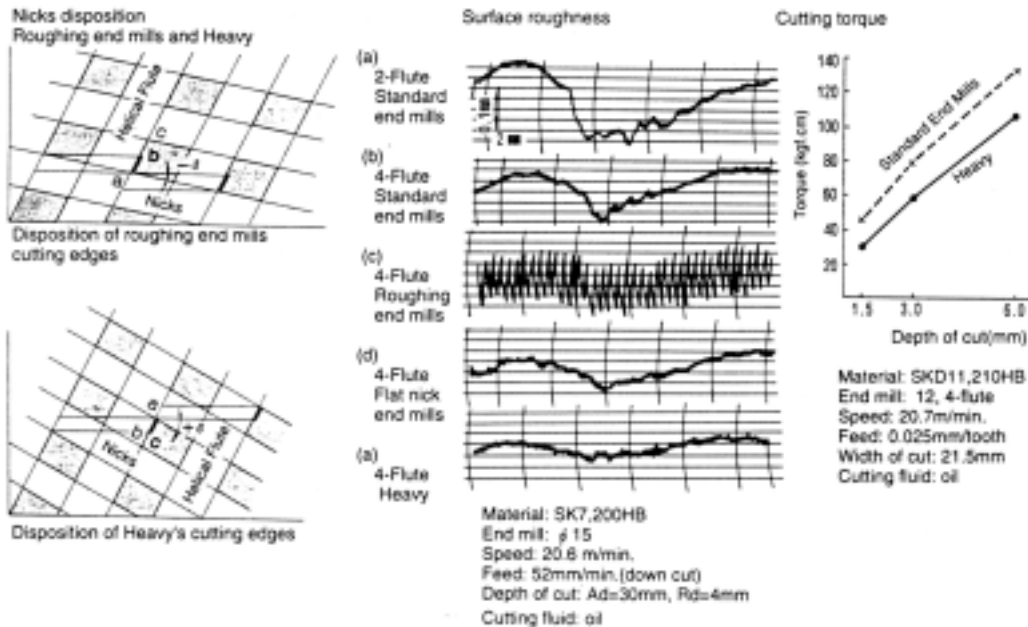

Technical Data

DRILLS

DRILLS
Cutting Condition

END MILLS

END MILLS
Cutting Condition

TAPS

TAPS
Cutting Condition

Others

Technical Data

DRILLS

DRILLS Cutting Condition

END MILLS

END MILLS Cutting Condition

TAPS

TAPS Cutting Condition

Others

NACHI THE BETTER END MILL

CNC Tolerances

New Nachi Premium Material End Mills are now made to CNC cutting diameter tolerances. The present close tolerance of Nachi End Mills is now closer than ever, as per table below.

Lead Specified

New Nachi Premium Material End Mills have the lead of spiral marked on the shank. This eliminates measuring the lead when setting up for resharpening and is a real time saver.

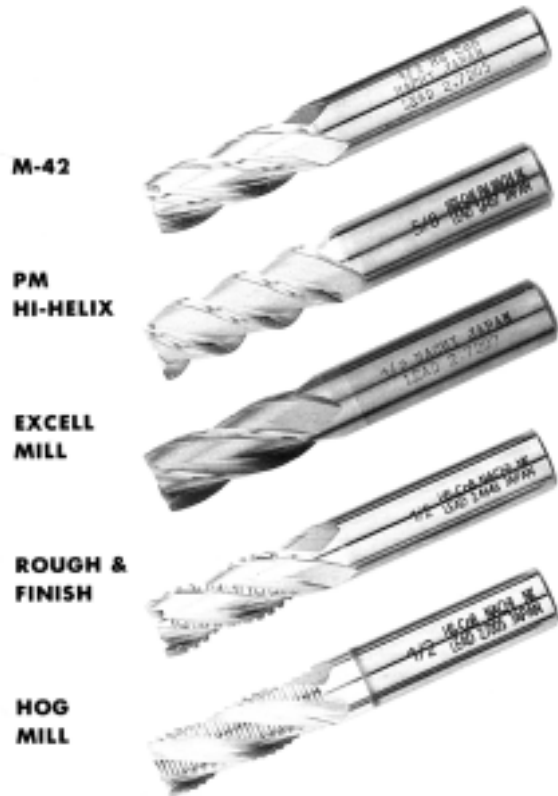

NACHI CNC TOLERANCE (Cutting Diameter)

+0.0010 0				0 -0.0010	
List No.	Tool No.	List No.	Tool No.	List No.	Tool No.
6201	PF	6233	PGE	6230	MPG
6203	PFL	6367	PK	6290	MPR
6207	PFX	6367P	PKP	±.0040	
6210	HPF	6367X	PKX		
6211M	PFC	7221P	PHP	6303	PQ
6211X	PFCX	0 -0.0015		6303P	PQP
6213	PFLC			6303X	PQX
6231	PG	6261	PC	6304	MPQ
6231X	PGX	6295	PRR	6305	PQA
				6307	PQF

*Some items, present stock until depleted.

WHEN PERFORMANCE COUNTS, COUNT ON GENAC

Genac Mills provide

- Higher Productivity
- Greater Cost Efficiency
- Highest Wear Resistance
- 3x Longer Life than TiN Carbide
- Precision Cutting
- ...and unique Nachi Geometry

Plus Nachi's unique start-to-finish total quality control for higher precision, better performance, closer tolerances and greater durability. Genac mills available in six standard types for super cutting performance. **All Competitively Priced!**

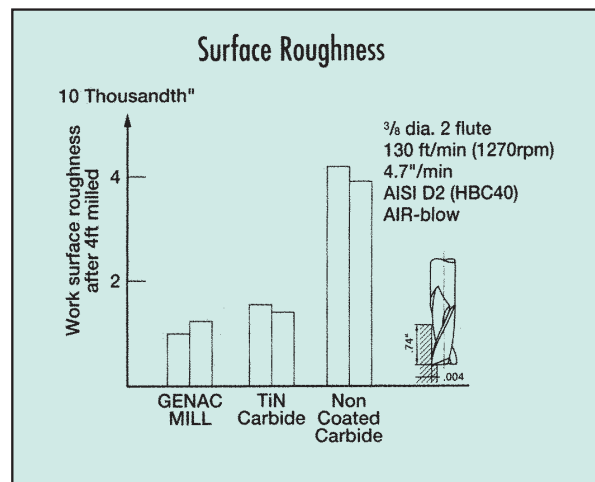
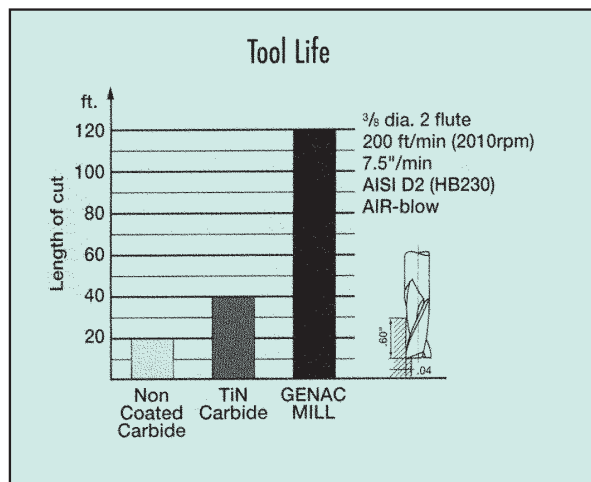
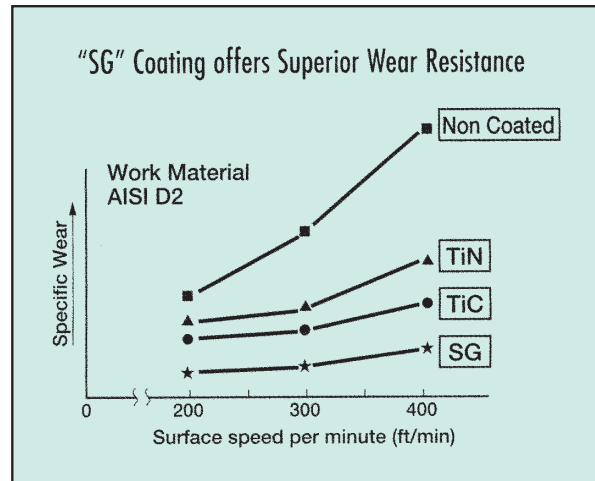
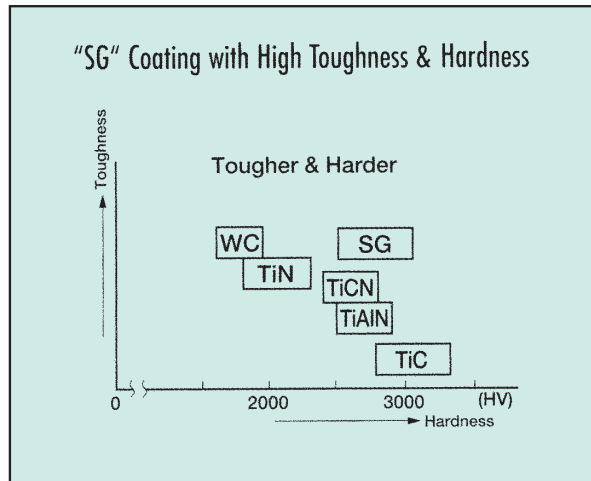

Technical Data

DRILLS

DRILLS
Cutting Condition

END MILLS

END MILLS
Cutting Condition

TAPS

TAPS
Cutting Condition

Others

RESHARPENING OF END MILLS

End mills should be sharpened before wear land exceeds the values shown in table to the right by grinding the cutting surface. Care should be taken to duplicate the original factory rake angle.

Peripheral Primary Relief Wear	Kind of Cutting Operation
.004 - .006	Precision Cutting Keyway Cutting
.012 max.	General Cutting
.020 - .025	Rough Cutting

Grinding Wheel Selections and Grinding Operations

End Mill Material	Application	Shape	Wheel Identification	Wheel (SFPM)	Infeed (.0001"/pass)
Cobalt High Speed Steel	Peripheral Relief	Straight	WA60J, WA60K	3800~5000	Rough 12~24 Finish 4~12
	End Teeth	Flare Cup	WA60~80K		
	Tooth Face	Dish	WA60K, WA80K		
Cobalt Vanadium High Speed Steel	Peripheral Relief	Straight	CBN 120~220	3800~5000	Rough 4~8 Finish 2~4
	End Teeth	Flare Cup	CBN 120~140		
	Tooth Face	Dish	CBN 120~140		
Carbide	Rough	Straight	DA100N	2600~3300	4~8
		Flare Cup Dish	GC60~80GmV		12~24
	Finish	Straight	DA150~180N		2~12
		Flare Cup Dish	GC100~120GmV		4~12

Resharpener Methods

Primary Relief Grinding

End Primary Relief Grinding

Tooth Face Grinding

End Gash Grinding

Application for Relief Angle, and Radial Rake Angle

Work Material	Radial Relief		Axial Relief		Tooth Face (Radial Rake Angle)
	Primary	Secondary	Primary	Secondary	
Steel	6° ~ 10°	20° ~ 25°	3° ~ 7°	10° ~ 25°	15°
Cast Iron	8° ~ 12°	20° ~ 25°	3° ~ 7°	10° ~ 25°	12°
Copper	10° ~ 15°	20° ~ 25°	8° ~ 12°	10° ~ 25°	10° ~ 20°
Light Alloy, Non-Ferrous Metal	10° ~ 15°	20° ~ 25°	8° ~ 12°	10° ~ 25°	15° ~ 20°

As for smaller mill dia. adopt bigger peripheral relief angle.

Technical Data

DRILLS

DRILLS
Cutting Condition

END MILLS

END MILLS
Cutting Condition

TAPS

TAPS
Cutting Condition

Others

RESHARPENING OF END MILLS

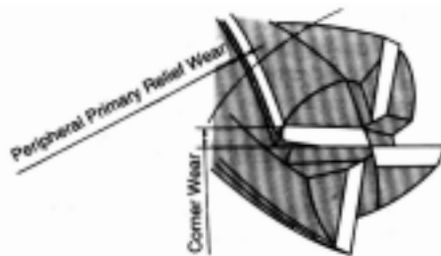

Peripheral Primary Relief Wear(mm)	Kind of Cutting Operation
0.1 ~ 0.15	Precision Cutting Keyway Cutting
0.3	General Cutting
0.5 ~ 0.7	Rough Cutting

Timing for Resharpener

Proper tooth profile must always be kept to ensure a longer tool life so that a higher productivity can be achieved. Generally, a timing for the resharpener can be observed by a wear on the peripheral primary relief as in shown above.

Resharpener methods of end mills are classified into
 (A) Peripheral Primary Relief Grinding for conventional types of end mills
 (B) Tooth Face (Rake Face) Grinding for roughing end mills, and coated end mills and formed end mills.
 (C) End Tooth Grinding for Keyway end mills.
 In case of (A), (C) is also required after 2 - 3 times of regrinding.

Out Dia. Relief Grinding

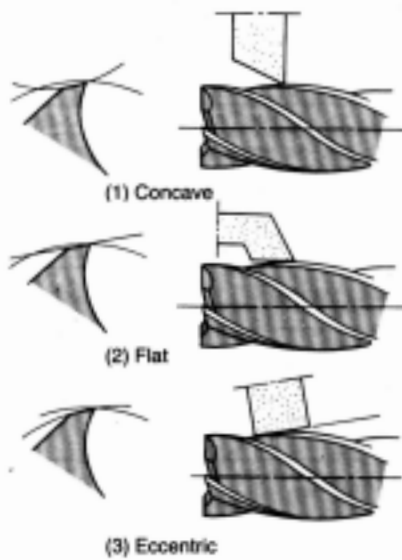

Tooth Face Grinding

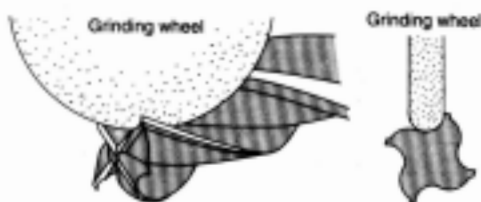

In regrinding coated end mills, tooth face (rake face) grinding is desirable.

End Tooth Grinding

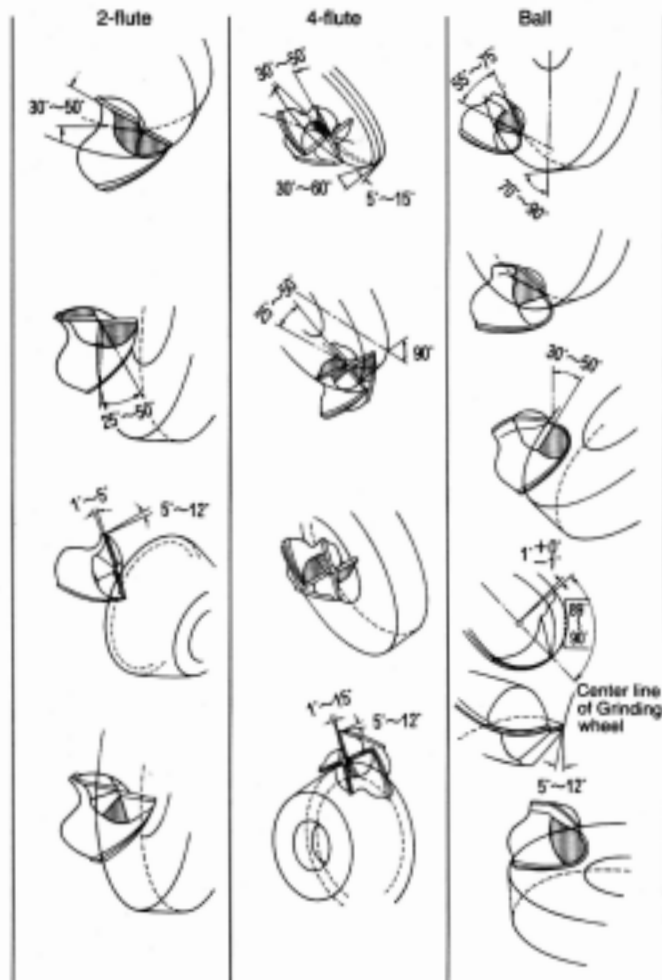

Technical Data

DRILLS

DRILLS
Cutting Condition

END MILLS

END MILLS
Cutting Condition

TAPS

TAPS
Cutting Condition

Others

Technical Data

DRILLS

DRILLS Cutting Condition

END MILLS

END MILLS Cutting Condition

TAPS

TAPS Cutting Condition

Others

CAUSES AND REMEDY FOR END MILL PROBLEM

Factors of end mill performance There are such causes which affect the end mill performance as shown in the figure. This so many factors are affecting the performance and end mills can not work well unless every factor is in the best condition.

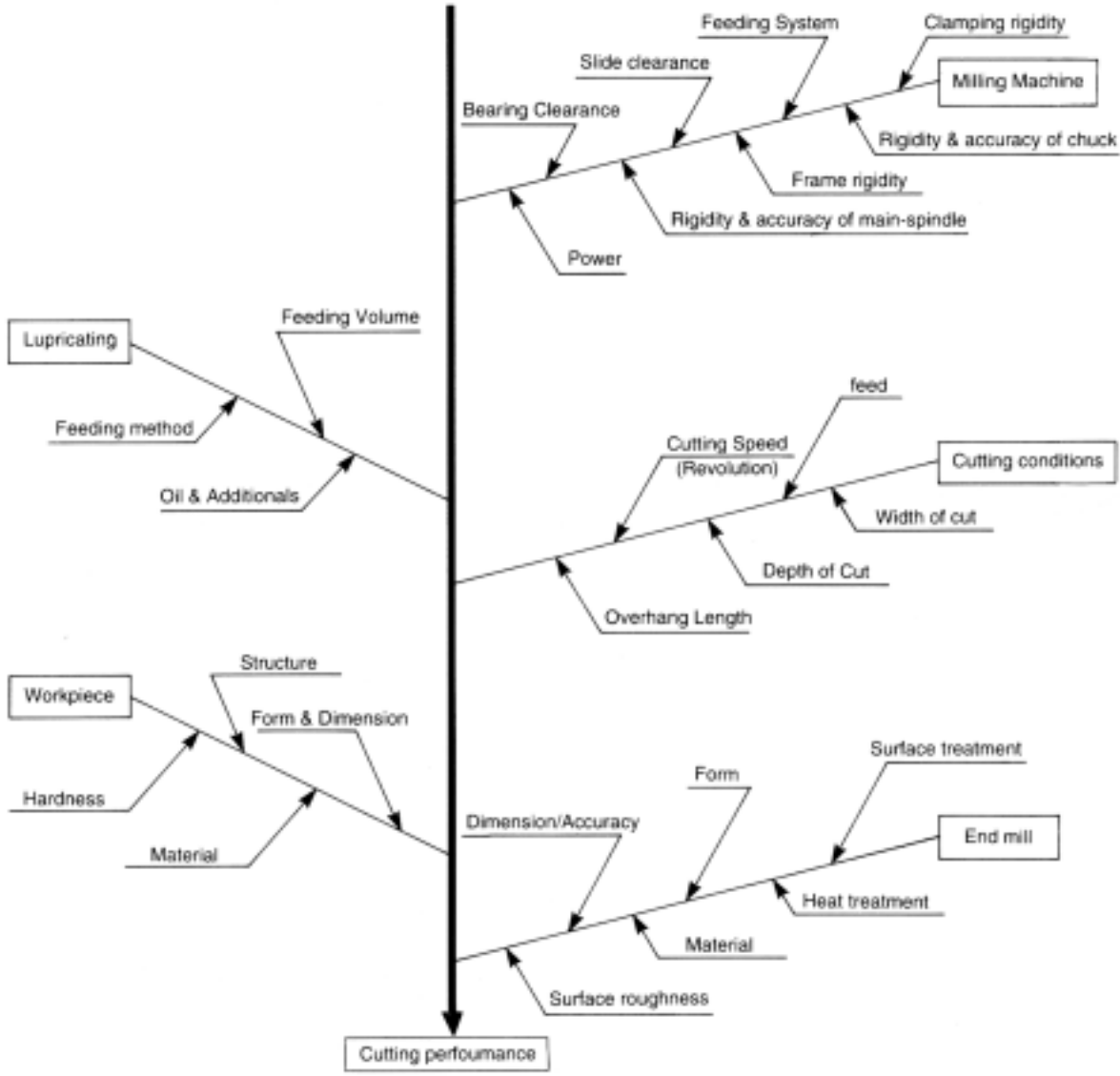

Cutting Performance	
1. Finished Accuracy	5. Breakage
2. Finished Roughness	6. Cutting noise
3. Wear	7. Burned Chips
4. Chipping	

TROUBLE-SHOOTING GUIDE FOR END MILL PROBLEMS

	Troubles	Factors	Countermeasures	
Surface Roughness	Rough Finish	Chatter	<ul style="list-style-type: none"> Increase rigidity of workpiece fixture Check machine condition, horsepower (H,P) Reduce cutting speed Consider conventional (up-cut) milling Use shortest possible length of tool, consider using special long reach holder 	
		Uneven hardness of workpiece	<ul style="list-style-type: none"> Use even hardness material 	
		Insufficient rake or relief	<ul style="list-style-type: none"> Resharpener cutter to correct geometry to suit cutting conditions 	
		Built-up edge, cold welding	<ul style="list-style-type: none"> Remove build-up edge & cold welding Check deterioration of cutting fluid 	
		Dull cutting edge	<ul style="list-style-type: none"> Provide timely resharpening 	
		Speed too high	<ul style="list-style-type: none"> Reduce cutting speed 	
		Improper or lack of cutting fluid	<ul style="list-style-type: none"> Change cutting fluid or lubricating system 	
	Torn Finish	Uneven wear on teeth	<ul style="list-style-type: none"> Remove wear by regrinding 	
		Cold welding on teeth	<ul style="list-style-type: none"> Remove cold welding Change cutting fluid 	
	Waviness	Bruise on teeth	Too small number of flutes	<ul style="list-style-type: none"> Try multi flute end mill, 2FLfi3FLfi4FL
Heavy cutting conditions			<ul style="list-style-type: none"> Reduce amount of radial depth of cut and feed 	
Helix angle too big			<ul style="list-style-type: none"> Use lower helix angle end mill 	
Form Error	Squareness (Perpendicularity)	Heavy cutting conditions Excessive overhang of cutter or workpiece Angular error of fixture	<ul style="list-style-type: none"> Reduce depth of cut and feed Use shortest possible length of tool, consider using special long reach holder Correct fixture angle 	
Tool Life	Short Life per Resharpening	Material too hard	<ul style="list-style-type: none"> Provide proper annealing Reduce feed and use upper grade material end mill 	
		Incorrect feed	<ul style="list-style-type: none"> Define proper feed 	
		Built-up edge, cold welding	<ul style="list-style-type: none"> Remove build-up edge or cold welding Use activative cutting fluid 	
		Insufficient coolant	<ul style="list-style-type: none"> Use proper cutting fluid Increase rate of coolant flow 	
		Incorrect resharpening	<ul style="list-style-type: none"> Resharpener cutter to correct geometry to suit cutting conditions 	
	Total Tool Life Too Short	Less number of resharpening	Improper time of resharpening	<ul style="list-style-type: none"> Regrind relief angle smaller Provide proper resharpening amount
			Material defect of workpiece	<ul style="list-style-type: none"> Provide timely resharpening
	Excessive Wear	Improper rake or relief	Insufficient performance of end mill	<ul style="list-style-type: none"> Use evenness hardness material Resharpener cutter to correct geometry to suit cutting conditions
			Insufficient performance of end mill	<ul style="list-style-type: none"> Use upper grade material end mill Try to use coated end mill
			Unsuitable cutting fluid	<ul style="list-style-type: none"> Select proper cutting fluid Correct lubricating system
			Improper time of resharpening	<ul style="list-style-type: none"> Provide timely resharpening
			Incorrect resharpening	<ul style="list-style-type: none"> Improve surface roughness on resharpening Prevent overheat of cutter grinding Remove build-up edge and weld deposit
			Chatter	<ul style="list-style-type: none"> Increase rigidity of workpiece fixture
	Chipping or Cracking	Material defect or workpiece	Feed too high	<ul style="list-style-type: none"> Use even hardness material Remove abnormal parts such as scale, sandtumbling etc.
			Dull cutting edge	<ul style="list-style-type: none"> Reduce feed speed
			Deterioration of cutting fluid	<ul style="list-style-type: none"> Provide resharpening
			Deterioration of cutting fluid	<ul style="list-style-type: none"> Provide new cutting fluid
	Breakage	Lack of rigidity in set-up	Dull cutting edge	<ul style="list-style-type: none"> Check component or fixture for security and rigidity
			Careless handling	<ul style="list-style-type: none"> Provide Resharpening
			Chip cram	<ul style="list-style-type: none"> Handle end mill carefully
Chip cram			<ul style="list-style-type: none"> Remove chips by air-jet cutting fluid 	

Technical Data

DRILLS

DRILLS Cutting Condition

END MILLS

END MILLS Cutting Condition

TAPS

TAPS Cutting Condition

Others

TAPS

Technical Data

DRILLS

DRILLS Cutting Condition

END MILLS

END MILLS Cutting Condition

TAPS

TAPS Cutting Condition

Others

Features

- Nachi Viper Taflet Taps** are specially engineered for steels, and require less torque than conventional coldform taps. This reduces the chance of breakage.
- Nachi Viper Taflet Taps** are steam oxide surface treated to limit adhesion from fusion, and carries coolant to the work area. Bright finish is available when required.
- Nachi Viper Taflet Taps** have more radial sections for higher accuracy of internal threads in steel. This compares favorably to coldform internal threads, which aren't always clean and accurate.



VIPER TAFLET

Work Materials

Structural Steels, Carbon Steels, Alloy Steels, Stainless Steels, Aluminum Alloys

Performance

TAFLET

Fiber flow is:

NOT INTERRUPTED.



Female thread cut by a TAFLET

Cutting Tap

Fiber flow is:

INTERRUPTED.



Female thread cut by a cutting tap

Features of TAFLET

Item	Cutting tap	TAFLET	TAFLET features
Tap breakdown	×	○	Does not break because there is no groove
Trouble caused by chips	×	○	No trouble because there is no chip
Accuracy of female thread	×	○	Little variations because of cold forming tapping
Female thread surface roughness	×	○	Excellent because threads are finished by sliding over the tap surface
Tapping torque	○	×	1.5 through 2.5 times the torque of a cutting tap
Female thread strength	×	○	Excellent because fiber flow is not interrupted in plastic working
Workpiece	○	×	Limited to the material of good malleability



DLC TAFLET

DLC TAFLET

Semi-Dry Tapping

Forming tap with DLC coating can be used in Aluminum, Aluminum Alloys, Die Cast Aluminum.

The tap shown below, M6x1.0, tapped 1,000 holes in A6061 with mist hole lube applied and has minimum adhesion of material.

Size: M6x1.0

Work Material: A6061-T6

Speed: 15m/min (49.2SFM)

Feed: 1.0mm/rev (0.039IPR)

Depth of Thread: 13mm

Coolant: mist lube (25cc x 2 nozzle /h)

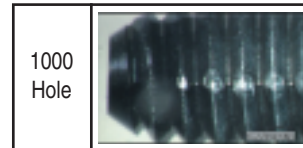

Stocked Size	Taps Name	List No.	Page
	DLC TAFLET THREAD FORMING TAPS / Fractional Sizes	6955	228
	DLC TAFLET THREAD FORMING TAPS / Machine Screw Sizes	6957	228
	DLC TAFLET THREAD FORMING TAPS / Metric Sizes	6956	229
	VIPER TAFLET THREAD FORMING TAPS / Machine Screw Sizes	995	240
	VIPER TAFLET THREAD FORMING TAPS / Fractional Sizes	995	241
	VIPER TAFLET THREAD FORMING TAPS / Metric Sizes	996	242

Features

- Viper T Series are suitable for various material.
- "Viper T for STAINLESS" series are the best taps for STAINLESS STEEL.

Work Materials

Structural Steels, Carbon Steels, Alloy Steels, Stainless Steels, Aluminum Alloys

Performance

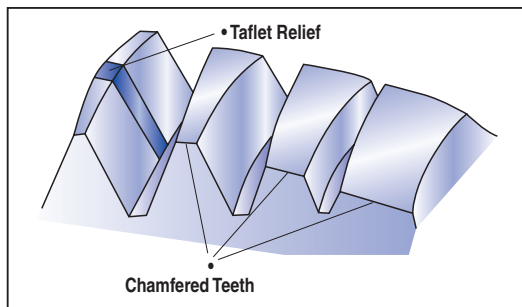

The results provide two-fold benefits. The first is minimal or no oversized thread diameter over the entire thread length, with smooth thread surfaces. The second is smooth chip ejection, ensuring freedom from chips for trouble-free performance, especially on machining centers and on unattended machining lines.



Nachi TDT Viper T-Series Taps were specifically designed to overcome the major difficulties of spiral fluted taps: oversizing and chip control. An all-new approach to these limitations also provides double-action tapping — **cutting** with chamfered teeth, plus **cold rolled forming** with a specially engineered shape of thread that we call Taflet Relief.



Conventional Taps

T-Series Taps

Stocked Size	Taps Name	List No.	Page
	VIPER T / Spiral Flute-Machine Screw Sizes	7981	233
	VIPER T / Spiral Flute-Fractional Sizes	7981	233
	VIPER T / Spiral Point-Machine Screw Sizes	7971	234
	VIPER T / Spiral Point-Fractional Sizes	7971	234
	VIPER T / Spiral Flute-Metric Sizes	7980	235
	VIPER T / Spiral Point-Metric Sizes	7970	235
	VIPER T / Spiral Flute-Machine Screw Sizes	7987	236
	VIPER T / Spiral Flute-Fractional Sizes	7987	236
	VIPER T FOR STAINLESS STEEL / Spiral Point-Machine Screw	7977	237
	VIPER T FOR STAINLESS STEEL / Spiral Point-Fractional Sizes	7977	237
	VIPER T FOR STAINLESS STEEL / Spiral Flute-Metric Sizes	7982	238
	VIPER T FOR STAINLESS STEEL / Spiral Point-Metric Sizes	7972	238

Technical Data

DRILLS

DRILLS Cutting Condition

END MILLS

END MILLS Cutting Condition

TAPS

TAPS Cutting Condition

Others

Taps / Selection Chart

Technical Data

DRILLS

DRILLS
Cutting Condition

END MILLS







END MILLS
Cutting Condition

TAPS





TAPS
Cutting Condition

Others





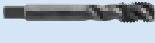

HIGH PERFORMANCE TAPS

Taps Name	Material	Coating		Stock Size	Stock USA ● Japan ○	LIST No		
						Page Size	Cutting Condition	
DLC TAFLET THREAD FORMING TAPS	HSSE-V	DLC	Fractional	1/4 to 1/2	●	6955		
			Machine Screw	2 to 12	●	p.228	p.260	
			Metric	M2 to M12	●	p.228	p.260	
SG Low Spiral TAPS	HSSE	SG	Fractional Machine Screw	2 to 12, 1/4 to 1	●	6959		
			Metric	M3 to M24	●	p.230	p.260	
					●	p.231	p.260	

VIPER T-SERIES FOR GENERAL PURPOSE

Taps Name	Material	Coating		Stock Size	Stock USA ● Japan ○	LIST No		
						Page Size	Cutting Condition	
VIPER T / Spiral Point	HSSE-V	Black Oxide	Fractional	1/4 to 1	●	7971		
			Machine Screw	2 to 12	●	p.234	p.260	
			Metric	M3 to M24	●	p.234	p.260	
VIPER T / Spiral Flute	HSSE-V	Black Oxide	Fractional	1/4 to 1	●	7970		
			Machine Screw	2 to 12	●	p.235	p.260	
			Metric	M3 to M24	●	p.233	p.260	

VIPER T-SERIES FOR STAINLESS STEEL

Taps Name	Material	Coating		Stock Size	Stock USA ● Japan ○	LIST No		
						Page Size	Cutting Condition	
VIPER T / Spiral Point	HSSE	Black Oxide	Fractional	1/4 to 1	●	7977		
			Machine Screw	2 to 12	●	p.237	p.260	
			Metric	M3 to M24	●	p.237	p.260	
VIPER T / Spiral Flute	HSSE	Black Oxide	Fractional	1/4 to 1	●	7972		
			Machine Screw	2 to 12	●	p.238	p.260	
			Metric	M3 to M24	●	p.236	p.260	

●:Great ○:Good △:OK

	Hole Condition				Workpiece Material										
	Blind Hole		Through Hole		Structural Steel (SS)	Carbon Steel	Alloy Steel (SCM, SCR)	Pre-Hardened Steel	Die Steel	Hardened Steel		Stainless Steel	Cast Iron	Aluminum Alloy	Copper Alloy
	<1.5 x Dia.	≥ 1.5 x Dia.	<1.5 x Dia.	≥ 1.5 x Dia.					HRC 25 to 40	HRC 45 to 50 50 to 65					
	●	○	●	○										●	●
	●	○	●	○										●	●
	●	○	●	○										●	●
	●	○	●	○				○	●	△					
	●	○	●	○				○	●	△					

Technical Data

DRILLS

DRILLS
Cutting Condition

	Hole Condition				Workpiece Material										
	Blind Hole		Through Hole		Structural Steel (SS)	Carbon Steel	Alloy Steel (SCM, SCR)	Pre-Hardened Steel	Die Steel	Hardened Steel		Stainless Steel	Cast Iron	Aluminum Alloy	Copper Alloy
	<1.5 x Dia.	≥ 1.5 x Dia.	<1.5 x Dia.	≥ 1.5 x Dia.					HRC 25 to 40	HRC 45 to 50 50 to 65					
			●	●	○	○	○	○					○	○	○
			●	●	○	○	○	○					○	○	○
			●	●	○	○	○	○					○	○	○
	●	○	△	△	○	○	○	○					○	○	○
	●	○	△	△	○	○	○	○					○	○	○
	●	○	△	△	○	○	○	○					○	○	○

END MILLS

END MILLS
Cutting Condition

	Hole Condition				Workpiece Material										
	Blind Hole		Through Hole		Structural Steel (SS)	Carbon Steel	Alloy Steel (SCM, SCR)	Pre-Hardened Steel	Die Steel	Hardened Steel		Stainless Steel	Cast Iron	Aluminum Alloy	Copper Alloy
	<1.5 x Dia.	≥ 1.5 x Dia.	<1.5 x Dia.	≥ 1.5 x Dia.					HRC 25 to 40	HRC 45 to 50 50 to 65					
			●	○	△	△	△	△				●	△	△	△
			●	○	△	△	△	△				●	△	△	△
			●	○	△	△	△	△				●	△	△	△
	●	○	△	△	△	△	△	△				●	△	△	△
	●	○	△	△	△	△	△	△				●	△	△	△
	●	○	△	△	△	△	△	△				●	△	△	△

TAPS

TAPS
Cutting Condition

Others

Taps / Selection Chart

Technical Data

DRILLS

DRILLS
Cutting Condition

END MILLS



END MILLS
Cutting Condition

TAPS







TAPS
Cutting Condition

Others

VIPER TAFLET

Taps Name	Material	Coating	Machine	Stock Size	Stock USA ● Japan ○	LIST No		Image
						Page Size	Page Cutting Condition	
VIPER TAFLET THREAD FORMING TAPS	HSSE-V	Black Oxide	Machine Screw	0 to 12	●	995	p.240 p.260	
			Fractional	1/4 to 3/4	●	995	p.241 p.260	
			Metric	2 to 20	●	996	p.242 p.260	

VTP TAPS

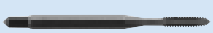
Taps Name	Material	Coating	Machine	Stock Size	Stock USA ● Japan ○	LIST No		Image
						Page Size	Page Cutting Condition	
VTP TAPS / Spiral Point	HSSE-V	Black Oxide	Fractional	1/4 to 1	●	971	p.245 p.260	
			Machine Screw	2 to 10	●	973	p.245 p.260	
			Metric	3 to 18	●	982	p.249 p.260	
Fractional			1/4 to 1	●	981	p.244 p.260		
Machine Screw			2 to 10	●	983	p.244 p.260		
Metric			3 to 18	●	980	p.249 p.260		
VTP TAPS / Roll Form	PREMIUM		Fractional	1/4 to 3/4	● *	991	p.247 p.260	
			Machine Screw	0 to 12	● *	993	p.246 p.260	

* : Discontinued items

●:Great ○:Good △:OK

	Hole Condition				Workpiece Material											
	Blind Hole		Through Hole		Structural Steel (SS)	Carbon Steel	Alloy Steel (SCM, SCR)	Pre-Hardened Steel	Die Steel		Hardened Steel		Stainless Steel	Cast Iron	Aluminum Alloy	Copper Alloy
	<1.5 x Dia.	≥ 1.5 x Dia.	<1.5 x Dia.	≥ 1.5 x Dia.					HRC 25 to 40	HRC 45 to 50	HRC 50 to 65					
	●	○	●	○	●	●	○					○				
	●	○	●	○	●	●	○					○				
	●	○	●	○	●	●	○					○				

	Hole Condition				Workpiece Material											
	Blind Hole		Through Hole		Structural Steel (SS)	Carbon Steel	Alloy Steel (SCM, SCR)	Pre-Hardened Steel	Die Steel		Hardened Steel		Stainless Steel	Cast Iron	Aluminum Alloy	Copper Alloy
	<1.5 x Dia.	≥ 1.5 x Dia.	<1.5 x Dia.	≥ 1.5 x Dia.					HRC 25 to 40	HRC 45 to 50	HRC 50 to 65					
			●	○	●	●	○	○					○	○	○	○
			●	○	●	●	○	○					○	○	○	○
			●	○	●	●	○	○					○	○	○	○
	●	○	△	△	●	●	○	○					○	○	○	○
	●	○	△	△	●	●	○	○					○	○	○	○
	●	○	△	△	●	●	○	○					○	○	○	○
	●	○	●	○	●	●	○					○				
	●	○	●	○	●	●	○					○				

Technical Data

DRILLS

DRILLS Cutting Condition

END MILLS

END MILLS Cutting Condition

TAPS

TAPS Cutting Condition

Others

STANDARD TAPS

Taps Name	Material	Coating	Stock Size	Stock USA ● Japan ○	LIST No		Image	
					Page Size	Page Cutting Condition		
Hand Taps	HSSE-V	Bright	Fractional	1/4 to 1-1/2	●	911		
						p.250 p.260		
	HSS	TiN	Fractional	1/4 to 1-1/2	●	911P		
						p.250 p.260		
	HSSE-V	Bright	Machine Screw	0 to 12	●	913		
					p.251 p.260			
Hand Taps-Cast Iron Taps	HSSE-V	Black Oxide	Inch	1/4 to 3/4	●	969		
								p.252 p.260
Spiral Point	HSS	Bright	Machine Screw	0 to 12	●	923		
						p.253 p.260		
		TiN	Machine Screw	0 to 12	●	923P		
						p.253 p.260		
	Black Oxide	Machine Screw	0 to 12	●	923S			
						p.253 p.260		
	HSSE-V	Bright	Fractional	1/4 to 3/4	●	921		
					p.252 p.260			
Spiral Flute	HSS	TiN	Fractional	1/4 to 3/4	●	921P		
								p.252 p.260
								HSSE-V
					p.252 p.260			
Fast Spiral Flute	HSS	Bright	Fractional	1/4 to 1/2	● *	931H		
								p.255 p.260
Hand Taps / .005 Oversized	Bright	Machine Screw	Fractional	6 to 10 1/4 to 1	● *	915		
								p.256 p.260
Spiral Point / .005 Oversized	Bright	Machine Screw	Fractional	6 to 10 1/4 to 3/4	●	925		
								p.256 p.260

* : Discontinued items

Technical Data

DRILLS

DRILLS Cutting Condition

END MILLS

END MILLS Cutting Condition

TAPS

TAPS Cutting Condition

Others

●:Great ○:Good △:OK

	Hole Condition				Workpiece Material										
	Blind Hole		Through Hole		Structural Steel (SS)	Carbon Steel	Alloy Steel (SCM, SCR)	Pre-Hardened Steel	Die Steel	Hardened Steel		Stainless Steel	Cast Iron	Aluminum Alloy	Copper Alloy
	<1.5 x Dia.	≥ 1.5 x Dia.	<1.5 x Dia.	≥ 1.5 x Dia.					HRC	HRC					
								25 to 40	45 to 50	50 to 65					
	●	○	●	○	△	△	△	△					△	△	△
	●	○	●	○	●	●	●	○				○	○	○	○
	●	○	●	○	△	△	△	△					△	△	△
	●	○	●	○	●	●	●	○				○	○	○	○
	●	○	●	○	△	△	△	△					△	△	△
	●	○	●	○	△	△	△	△					●		
	/	/	●	○	△	△	△	△					△	△	△
	/	/	●	○	●	●	●	○				○	○	○	○
	/	/	●	○	△	△	△	△					△	△	△
	/	/	●	○	△	△	△	△					△	△	△
	/	/	●	○	●	●	●	○				○	○	○	○
	/	/	●	○	△	△	△	△					△	△	△
	●	○	●	○	△	△	△	△					△	△	△
	●	○	△	△	△	△	△	△					△	△	△
	●	○	△	△	△	△	△	△					△	△	△
	●	○	△	△	△	△	△	△					△	△	△
	●	○	△	△	△	△	△	△					△	△	△
	●	○	△	△	△	△	△	△					△	△	△
	●	○	●	○	△	△	△	△					△	△	△
	/	/	●	○	△	△	△	△					△	△	△

Technical Data

DRILLS

DRILLS Cutting Condition

END MILLS

END MILLS Cutting Condition

TAPS

TAPS Cutting Condition

Others

Taps / Selection Chart

PIPE TAPS

Taps Name	Material	Coating		Stock Size	Stock USA ● Japan ○	LIST No		Image
						Page		
						Size	Cutting Condition	
Taper Pipe Taps	HSS	Bright	NPT	1/16 to 2	●	941		
						p.257	p.260	
	HSSE-V	Black Oxide	NPT	1/16 to 2	●	941P		
						p.257	p.260	
Taper Pipe Taps / Dry Seal	HSS	Bright	NPT	1/8 to 2	●	943		
						p.257	p.260	
Taper Pipe Taps / Dry Seal	HSS	Bright	NPTF	1/16 to 2	●	941D		
						p.257	p.260	
Taper Pipe Taps / Dry Seal	HSSE-V	Black Oxide	NPTF	1/16 to 1	●	947D		
						p.258	p.260	
Straight Pipe Taps	HSS	Bright	NPS	1/8 to 1	●	945		
						p.258	p.260	
Straight Pipe Tap / Dry Seal	HSS	Bright	NPSF	1/8 to 1	●	945D		
						p.258	p.260	

Technical Data

DRILLS

DRILLS Cutting Condition

END MILLS

END MILLS Cutting Condition

TAPS

TAPS Cutting Condition

Others

●:Great ○:Good △:OK

	Hole Condition				Workpiece Material										
	Blind Hole		Through Hole		Structural Steel (SS)	Carbon Steel	Alloy Steel (SCM, SCR)	Pre-Hardened Steel	Die Steel	Hardened Steel		Stainless Steel	Cast Iron	Aluminum Alloy	Copper Alloy
	<1.5 x Dia.	≥ 1.5 x Dia.	<1.5 x Dia.	≥ 1.5 x Dia.					HRC	HRC					
								25 to 40	45 to 50	50 to 65					
	○	△	○	△	△	△	△	△					△	△	△
	●	○	●	○	●	●	●	○				○	○	○	○
	○	△	○	△	○	○	○	○					○	○	○
	○	△	○	△	△	△	△	△					△	△	△
	○	△	○	△	△	△	△	△					△	△	△
	○	△	○	△	○	○	○	○					○	○	○
	○	△	○	△	△	△	△	△					△	△	△
	○	△	○	△	△	△	△	△					△	△	△

Technical Data

DRILLS

DRILLS Cutting Condition

END MILLS

END MILLS Cutting Condition

TAPS

TAPS Cutting Condition

Others

DLC TAFLET THREAD FORMING TAPS / FRACTIONAL SIZE
DLC TAFLET THREAD FORMING TAPS / MACHINE SCREW SIZES

Technical Data

List No.6955 Fractional Size



Bottoming Style
DLC Coating



Forming TAP with DLC coating can be used in Aluminum Alloy, Die Cast Aluminum and Copper.

DRILLS

Nominal Size	Thread/Inch		E. D. P. Numbers								Dimensions			Std. Pack.
	NC UNC	NF UNF	H2	H3	H4	H5	H6	H7	H8	H10	Overall Length	Length of Thread	Shank Dia.	
1/4	20	28			97838		97912				2 1/2	0.591	0.255	3
					97840		97914				2 1/2	0.591	0.255	3
5/16	18	24				97873		97931			2 23/32	0.669	0.318	3
						97875		97933			2 23/32	0.669	0.318	3
3/8	16	24				97877		97935			2 15/16	0.748	0.381	3
						97879		97937			2 15/16	0.748	0.381	3
7/16	14					97881					3 5/32	0.866	0.323	3
1/2	13					97885					3 3/8	0.984	0.367	3

DRILLS Cutting Condition

END MILLS

List No.6957 Machine Screw Sizes



Bottoming Style
DLC Coating



Forming TAP with DLC coating can be used in Aluminum Alloy, Die Cast Aluminum and Copper.

END MILLS Cutting Condition

Nominal Size	Thread/Inch		E. D. P. Numbers								Dimensions			Std. Pack.
	NC UNC	NF UNF	H2	H3	H4	H5	H6	H7	H8	H10	Overall Length	Length of Thread	Shank Dia.	
2	56		97738	97776							1 3/4	0.437	0.141	3
4	40			97784		97857					1 7/8	0.354	0.141	3
6	32			97792		97865					2	0.433	0.141	3
8	32			97796		97869					2 1/8	0.472	0.168	3
10	24	32			97830		97904				2 3/8	0.551	0.194	3
					97832		97906				2 3/8	0.551	0.194	3
12	24				97834		97908				2 3/8	0.551	0.220	3

TAPS

TAPS Cutting Condition

Others

List No.6956 Metric Sizes



Bottoming Style
DLC Coating



Forming TAP with DLC coating can be used in Aluminum Alloy, Die Cast Aluminum and Copper.

Nominal Size (mm)	Pitch (mm)	E. D. P. Numbers								Dimensions			Std. Pack.
		D3	D4	D5	D6	D7	D8	D9	D10	Overall Length	Length of Thread	Shank Dia.	
2	0.4	91002								1 3/4	0.437	0.119	3
2.5	0.45	91008								1 13/16	0.500	0.119	3
3	0.5	91011								1 15/16	0.394	0.141	3
4	0.7		91017							2 1/8	0.472	0.168	3
5	0.8		91023							2 3/8	0.551	0.194	3
6	1			91026				91027		2 1/2	0.591	0.255	3
8	1.25						91035	91036		2 23/32	0.669	0.318	3
10	1.25						91038			2 15/16	0.748	0.381	3
	1.5							91041		2 15/16	0.748	0.381	3
12	1.75								91047	3 3/8	0.984	0.367	3

Technical Data

DRILLS

DRILLS
Cutting Condition

END MILLS

END MILLS
Cutting Condition

TAPS

TAPS
Cutting Condition

Others

SG LO-SPIRAL FLUTED TAPS / MACHINE SCREW SIZES & FRACTIONAL SIZE

List No.6959



Modified Bottoming Style 2 1/2 to 3 Thread Lead
SG Coating



*GT to H-limit conversion chart refer to Page:270

Nominal Size	Thread/Inch		No. of Flutes	E.D.P. Numbers							Dimensions			Std . Pack.
	NC UNC	NF UNF		GT3	GT4	GT5	GT6	GT7	GT8	GT9	Overall Length	Length of Thread	Shank Dia.	
MACHINE SCREW SIZES														
2	56		3	94597							1 3/4	0.437	0.141	3
		64	3	94598							1 3/4	0.437	0.141	3
3	48		3		94599						1 13/16	0.500	0.141	3
		56	3	94600							1 13/16	0.500	0.141	3
4	40		3			94601					1 7/8	0.236	0.141	3
		48	3		94602						1 7/8	0.236	0.141	3
5	40		3			94603					1 15/16	0.236	0.141	3
		44	3			94604					1 15/16	0.236	0.141	3
6	32		3			94605					2	0.276	0.141	3
		40	3			94606					2	0.276	0.141	3
8	32		3			94607					2 1/8	0.276	0.168	3
		36	3			94608					2 1/8	0.276	0.168	3
10	24		3				94609				2 3/8	0.354	0.194	3
		32	3			94610					2 3/8	0.354	0.194	3
12	24		3				94611				2 3/8	0.354	0.220	3
		28	3				94612				2 3/8	0.354	0.220	3
FRACTIONAL SIZES														
1/4	20		3		941633			94613			2 1/2	0.433	0.255	3
		28	3		941634		94614				2 1/2	0.433	0.255	3
5/16	18		3		941635			94615			2 23/32	0.472	0.318	3
		24	3		941636			94616			2 23/32	0.472	0.318	3
3/8	16		3		941637				94617		2 15/16	0.551	0.381	3
		24	3		941638				94618		2 15/16	0.551	0.381	3
7/16	14		3						94619		3 5/32	0.709	0.323	3
		20	3		941639				94620		3 5/32	0.709	0.323	3
1/2	13		3		941640				94621		3 3/8	0.787	0.367	3
		20	3		941641				94622		3 3/8	0.787	0.367	3
9/16	12		3						94623		3 19/32	0.827	0.429	3
		18	3						94624		3 19/32	0.827	0.429	3
5/8	11		3							94625	3 13/16	0.905	0.480	3
		18	3							94626	3 13/16	0.905	0.480	3
3/4	10		4							94627	4 1/4	0.984	0.590	3
		16	4							94628	4 1/4	0.984	0.590	3
7/8	9		4							94629	4 11/16	1.102	0.697	3
		14	4							94630	4 11/16	1.102	0.697	3
1	8		4							94631	5 1/8	1.260	0.800	3
		12	4							94632	5 1/8	1.260	0.800	3

Technical Data

DRILLS

DRILLS Cutting Condition

END MILLS

END MILLS Cutting Condition

TAPS

TAPS Cutting Condition

Others

List No.6958 Metric Sizes



Modified Bottoming Style 2 1/2 to 3 Thread Lead
SG Coating



*GT to H-limit conversion chart refer to Page:270

Nominal Size (mm)	Pitch (mm)	No. Of Flutes	E. D. P. Numbers					Dimensions			Std. Pack.
			GT5	GT6	GT7	GT8	GT9	Overall Length	Length of Thread	Shank Dia.	
METRIC											
3	0.5	3	59615					1 15/16	0.236	0.141	3
4	0.7	3	59617					2 1/8	0.276	0.168	3
5	0.8	3		59619				2 3/8	0.354	0.194	3
6	1	3		59620				2 1/2	0.433	0.255	3
8	1	3		59622				2 23/32	0.472	0.318	3
	1.25	3		59623				2 23/32	0.472	0.318	3
10	1.25	3		59624				2 15/16	0.551	0.381	3
	1.5	3			59625			2 15/16	0.551	0.381	3
12	1.25	3				59626		3 3/8	0.669	0.367	3
	1.75	3				59627		3 3/8	0.669	0.367	3
14	1.5	3				59628		3 19/32	0.787	0.429	3
	2	3				59629		3 19/32	0.787	0.429	3
16	1.5	3				59630		3 13/16	0.787	0.480	3
	2	3				59631		3 13/16	0.787	0.480	3
18	1.5	4				59632		4 1/32	0.984	0.542	3
	2.5	4					59633	4 1/32	0.984	0.542	3
20	1.5	4				59634		4 15/32	0.984	0.652	3
	2.5	4					59635	4 15/32	0.984	0.652	3
22	1.5	4				59636		4 11/16	0.984	0.697	3
	2.5	4					59637	4 11/16	0.984	0.697	3
24	1.5	4				59638		4 29/32	1.181	0.760	3
	3	4					59639	4 29/32	1.181	0.760	3

Technical Data

DRILLS

DRILLS
Cutting Condition

END MILLS

END MILLS
Cutting Condition

TAPS

TAPS
Cutting Condition

Others

NACHI VIPER

Viper taps go straight to the heart of tough work with problem-free tapping of stainless steel and other advanced metals. They provide superior threads and less torque, faster chip removal and cooler tapping job after job.

All this because Viper taps are made exclusively of specialty high speed steels, heat treated to maximize the advanced heat resistance characteristics of Cobalt and Tungsten and the wear resistance of Vanadium.

No tap is better engineered than Viper to demonstrate a longer tool life working in advanced materials with less down time and more economy. The special geometry extends tap life and the standard steam oxide maximizes the cooling effect to make rigorous tapping easy. Bright finish taps are also available where required for non-ferrous materials or special coatings as required. CNC manufacturing assures consistent quality time after time.



COMPARISON CHART

TOOL LIFE COMPARISON TEST RESULT (1)

Tap: Spiral point tap M10 x 1.5 Plug
 Material: SUS 630 (HRC=45), Thickness 20mm
 Drill: 8.5mm dia.
 Tapping speed: 8.8 m/min.

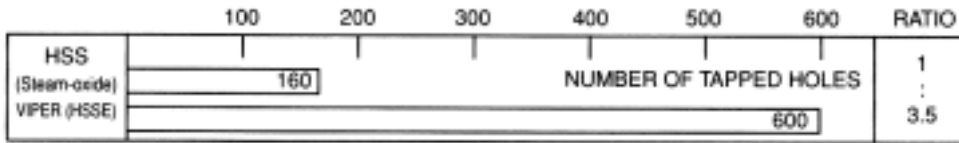

TOOL LIFE COMPARISON TEST RESULT (2)

Tap: Spiral point tap M12 x 1.75 Plug
 Material: SUS 304 (HRC=30~35) Cold formed nut, Thickness 15mm
 Drill: 10.3mm dia.
 Tapping speed: 9.5 m/min.

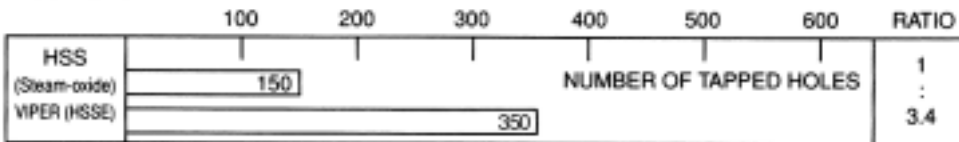

TOOL LIFE COMPARISON TEST RESULT (3)

Tap: Spiral point tap M8 x 1.25 C2.5P Plug
 Material: SUS 304 (HRC=20~25), Thickness 18mm
 Drill: 6.7mm dia.
 Tapping speed: 8.2 m/min.

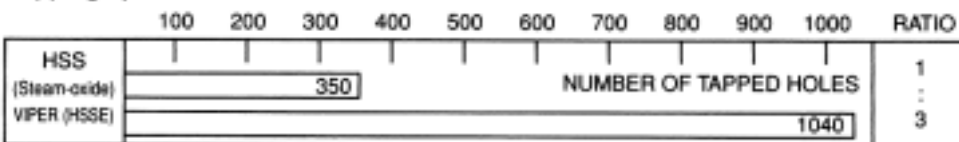

List No.7981



Modified Bottoming Style, 2 1/2 To 3 Thread Lead
Surface Treated

VANADIUM HIGH SPEED STEEL HSSE-V



*GT to H-limit conversion chart refer to Page:270

Nominal Size	Thread/Inch		No. of Flutes	E.D.P. Numbers							Dimensions			Std. Pack.
	NC UNC	NF UNF		GT3	GT4	GT5	GT6	GT7	GT8	GT9	Overall Length	Length of Thread	Shank Dia.	
MACHINE SCREW SIZES														
2	56	64	3	97597	—	—	—	—	—	—	1 3/4	0.437	0.141	3
			3	97598	—	—	—	—	—	—	1 3/4	0.437	0.141	3
3	48	56	3	—	97599	—	—	—	—	—	1 13/16	0.500	0.141	3
			3	97600	—	—	—	—	—	—	1 13/16	0.500	0.141	3
4	40	48	3	—	—	97601	—	—	—	—	1 7/8	0.236	0.141	3
			3	—	97602	—	—	—	—	—	1 7/8	0.236	0.141	3
5	40	44	3	—	—	97603	—	—	—	—	1 15/16	0.236	0.141	3
			3	—	—	97604	—	—	—	—	1 15/16	0.236	0.141	3
6	32	40	3	—	—	97605	—	—	—	—	2	0.276	0.141	3
			3	—	—	97606	—	—	—	—	2	0.276	0.141	3
8	32	36	3	—	—	97607	—	—	—	—	2 1/8	0.276	0.168	3
			3	—	—	97608	—	—	—	—	2 1/8	0.276	0.168	3
10	24	32	3	—	—	—	97609	—	—	—	2 3/8	0.354	0.194	3
			3	—	—	97610	—	—	—	—	2 3/8	0.354	0.194	3
12	24	28	3	—	—	—	97611	—	—	—	2 3/8	0.354	0.220	3
			3	—	—	—	97612	—	—	—	2 3/8	0.354	0.220	3
FRACTIONAL SIZES														
1/4	20	28	3	—	97633	—	—	97613	—	—	2 1/2	0.433	0.255	3
			3	—	97638	—	97614	—	—	—	2 1/2	0.433	0.255	3
5/16	18	24	3	—	97643	—	—	97615	—	—	2 23/32	0.472	0.318	3
			3	—	97648	—	—	97616	—	—	2 23/32	0.472	0.318	3
3/8	16	24	3	—	97653	—	—	—	97617	—	2 15/16	0.551	0.381	3
			3	—	97658	—	—	97618	—	—	2 15/16	0.551	0.381	3
7/16	14	20	3	—	97663	—	—	—	97619	—	3 5/32	0.709	0.323	3
			3	—	97668	—	—	—	97620	—	3 5/32	0.709	0.323	3
1/2	13	20	3	—	97673	—	—	—	97621	—	3 3/8	0.787	0.367	3
			3	—	97678	—	—	—	97622	—	3 3/8	0.787	0.367	3
9/16	12	18	3	—	97683	—	—	—	97623	—	3 19/32	0.827	0.429	3
			3	—	97688	—	—	—	97624	—	3 19/32	0.827	0.429	3
5/8	11	18	3	—	97693	—	—	—	—	97625	3 13/16	0.906	0.480	3
			3	—	97698	—	—	—	97626	—	3 13/16	0.906	0.480	3
3/4	10	16	3	—	97705	—	—	—	—	97627	4 1/4	0.984	0.590	3
			3	—	97710	—	—	—	97628	—	4 1/4	0.984	0.590	3
7/8	9	14	4	—	—	97715	—	—	—	97629	4 11/16	1.102	0.697	3
			4	—	—	97720	—	—	—	97630	4 11/16	1.102	0.697	3
1	8	12	4	—	—	97725	—	—	—	97631	5 1/8	1.260	0.800	3
			4	—	—	97730	—	—	—	97632	5 1/8	1.260	0.800	3

Technical Data

DRILLS

DRILLS
Cutting Condition

END MILLS

END MILLS
Cutting Condition

TAPS

TAPS
Cutting Condition

Others

VIPER T SERIES-SPIRAL POINTED / GENERAL PURPOSE

List No.7971

VANADIUM HIGH SPEED STEEL HSSE-V



Plug Style, 4 To 5 Thread Surface Treated



*GT to H-limit conversion chart refer to Page:270

Nominal Size	Thread/Inch		No. of Flutes	E.D.P. Numbers							Dimensions			Std. Pack.
	NC UNC	NF UNF		GT3	GT4	GT5	GT6	GT7	GT8	GT9	Overall Length	Length of Thread	Shank Dia.	
MACHINE SCREW SIZES														
2	56	64	2	98597	—	—	—	—	—	—	1 3/4	0.437	0.141	3
		64	2	98598	—	—	—	—	—	—	1 3/4	0.437	0.141	3
3	48	56	2	—	98599	—	—	—	—	—	1 13/16	0.500	0.141	3
		56	2	98600	—	—	—	—	—	—	1 13/16	0.500	0.141	3
4	40	48	2	—	—	98601	—	—	—	—	1 7/8	0.354	0.141	3
		48	2	—	98602	—	—	—	—	—	1 7/8	0.354	0.141	3
5	40	44	3	—	—	98603	—	—	—	—	1 15/16	0.394	0.141	3
		44	3	—	—	98604	—	—	—	—	1 15/16	0.394	0.141	3
6	32	40	3	—	—	98605	—	—	—	—	2	0.433	0.141	3
		40	3	—	—	98606	—	—	—	—	2	0.433	0.141	3
8	32	36	3	—	—	98607	—	—	—	—	2 1/8	0.472	0.168	3
		36	3	—	—	98608	—	—	—	—	2 1/8	0.472	0.168	3
10	24	32	3	—	—	—	98609	—	—	—	2 3/8	0.551	0.194	3
		32	3	—	—	98610	—	—	—	—	2 3/8	0.551	0.194	3
12	24	28	3	—	—	—	98611	—	—	—	2 3/8	0.551	0.220	3
		28	3	—	—	—	98612	—	—	—	2 3/8	0.551	0.220	3
FRACTIONAL SIZES														
1/4	20	28	3	—	98633	—	—	98613	—	—	2 1/2	0.591	0.255	3
		28	3	—	98638	—	98614	—	—	—	2 1/2	0.591	0.255	3
5/16	18	24	3	—	98643	—	—	98615	—	—	2 23/32	0.669	0.318	3
		24	3	—	98648	—	—	98616	—	—	2 23/32	0.669	0.318	3
3/8	16	24	3	—	98653	—	—	—	98617	—	2 15/16	0.748	0.381	3
		24	3	—	98658	—	—	98618	—	—	2 15/16	0.748	0.381	3
7/16	14	20	3	—	98663	—	—	—	98619	—	3 5/32	0.984	0.323	3
		20	3	—	98668	—	—	—	98620	—	3 5/32	0.984	0.323	3
1/2	13	20	3	—	98673	—	—	—	98621	—	3 3/8	1.142	0.367	3
		20	3	—	98678	—	—	—	98622	—	3 3/8	1.142	0.367	3
9/16	12	18	3	—	98683	—	—	—	98623	—	3 19/32	1.181	0.429	3
		18	3	—	98688	—	—	—	98624	—	3 19/32	1.181	0.429	3
5/8	11	18	3	—	98693	—	—	—	—	98625	3 13/16	1.260	0.480	3
		18	3	—	98698	—	—	—	98626	—	3 13/16	1.260	0.480	3
3/4	10	16	3	—	98705	—	—	—	—	98627	4 1/4	1.457	0.590	3
		16	3	—	98710	—	—	—	98628	—	4 1/4	1.457	0.590	3
7/8	9	14	3	—	—	98715	—	—	—	—	4 11/16	1.496	0.697	3
		14	4	—	—	98720	—	—	—	—	4 11/16	1.496	0.697	3
1	8	12	3	—	—	98725	—	—	—	—	5 1/8	1.772	0.800	3
		12	4	—	—	98730	—	—	—	—	5 1/8	1.772	0.800	3

Technical Data

DRILLS

DRILLS Cutting Condition

END MILLS

END MILLS Cutting Condition

TAPS

TAPS Cutting Condition

Others

List No.7980 Spiral Fluted

VANADIUM HIGH SPEED STEEL HSSE-V



Modified Bottoming Style, 2 1/2 To 3 Thread
Surface Treated



*GT to H-limit conversion chart refer to Page:270

Nominal Size (mm)	Pitch (mm)	No. Of Flutes	E.D.P. Number					Dimensions			Std. Pack.
			GT5	GT6	GT7	GT8	GT9	Overall Length	Length of Thread	Shank Dia.	
METRIC											
3	0.5	3	57615	—	—	—	—	1 15/16	0.236	0.141	3
3.5	0.6	3	57616	—	—	—	—	2	0.276	0.141	3
4	0.7	3	57617	—	—	—	—	2 1/8	0.276	0.168	3
5	0.8	3	—	57619	—	—	—	2 3/8	0.354	0.194	3
6	1	3	—	57620	—	—	—	2 1/2	0.433	0.255	3
7	1	3	—	57621	—	—	—	2 23/32	0.472	0.318	3
8	1	3	—	57622	—	—	—	2 23/32	0.472	0.318	3
8	1.25	3	—	57623	—	—	—	2 23/32	0.472	0.318	3
10	1.25	3	—	57624	—	—	—	2 15/16	0.551	0.381	3
10	1.5	3	—	—	57625	—	—	2 15/16	0.551	0.381	3
12	1.25	3	—	—	—	57626	—	3 3/8	0.669	0.367	3
12	1.75	3	—	—	—	57627	—	3 3/8	0.669	0.367	3
14	1.5	3	—	—	—	57628	—	3 19/32	0.787	0.429	3
14	2	3	—	—	—	57629	—	3 19/32	0.787	0.429	3
16	1.5	3	—	—	—	57630	—	3 13/16	0.787	0.480	3
16	2	3	—	—	—	57631	—	3 13/16	0.787	0.480	3
18	1.5	3	—	—	—	57632	—	4 1/32	0.984	0.542	3
18	2.5	3	—	—	—	—	57633	4 1/32	0.984	0.542	3
20	1.5	4	—	—	—	57634	—	4 15/32	0.984	0.652	3
20	2.5	4	—	—	—	—	57635	4 15/32	0.984	0.652	3
22	1.5	4	—	—	—	57636	—	4 11/16	0.984	0.697	3
22	2.5	4	—	—	—	—	57637	4 11/16	0.984	0.697	3
24	1.5	4	—	—	—	57638	—	4 29/32	1.181	0.760	3
24	3	4	—	—	—	—	57639	4 29/32	1.181	0.760	3

List No.7970 Spiral Pointed

VANADIUM HIGH SPEED STEEL HSSE-V



Plugstyle, 4 To 5 Thread
Surface Treated



*GT to H-limit conversion chart refer to Page:270

Nominal Size (mm)	Pitch (mm)	No. Of Flutes	E.D.P. Number					Dimensions			Std. Pack.
			GT5	GT6	GT7	GT8	GT9	Overall Length	Length of Thread	Shank Dia.	
METRIC											
3	0.5	3	58615	—	—	—	—	1 15/16	0.394	0.141	3
3.5	0.6	3	58616	—	—	—	—	2	0.433	0.141	3
4	0.7	3	58617	—	—	—	—	2 1/8	0.472	0.168	3
5	0.8	3	—	58619	—	—	—	2 3/8	0.551	0.194	3
6	1	3	—	58620	—	—	—	2 1/2	0.591	0.255	3
7	1	3	—	58621	—	—	—	2 23/32	0.669	0.318	3
8	1	3	—	58622	—	—	—	2 23/32	0.669	0.318	3
8	1.25	3	—	58623	—	—	—	2 23/32	0.669	0.318	3
10	1.25	3	—	58624	—	—	—	2 15/16	0.748	0.381	3
10	1.5	3	—	—	58625	—	—	2 15/16	0.748	0.381	3
12	1.25	3	—	—	—	58626	—	3 3/8	1.142	0.367	3
12	1.75	3	—	—	—	58627	—	3 3/8	1.142	0.367	3
14	1.5	3	—	—	—	58628	—	3 19/32	1.181	0.429	3
14	2	3	—	—	—	58629	—	3 19/32	1.181	0.429	3
16	1.5	3	—	—	—	58630	—	3 13/16	1.260	0.480	3
16	2	3	—	—	—	58631	—	3 13/16	1.260	0.480	3
18	1.5	3	—	—	—	58632	—	4 1/32	1.457	0.542	3
18	2.5	3	—	—	—	—	58633	4 1/32	1.457	0.542	3
20	1.5	3	—	—	—	58634	—	4 15/32	1.457	0.652	3
20	2.5	3	—	—	—	—	58635	4 15/32	1.457	0.652	3
22	1.5	4	—	—	—	58636	—	4 11/16	1.496	0.697	3
22	2.5	3	—	—	—	—	58637	4 11/16	1.496	0.697	3
24	1.5	4	—	—	—	58638	—	4 29/32	1.772	0.760	3
24	3	3	—	—	—	—	58639	4 29/32	1.772	0.760	3

Technical Data

DRILLS

DRILLS Cutting Condition

END MILLS

END MILLS Cutting Condition

TAPS

TAPS Cutting Condition

Others

VIPER T SERIES-SPIRAL FLUTED / FOR STAINLESS STEEL

List No.7987



Modified Bottoming Style 2 1/2 To 3 Thread Lead
Surface Treated

COBALT/VANADIUM HIGH SPEED STEEL HSSE



*GT to H-limit conversion chart refer to Page:270

Nominal Size	Thread/Inch		No. of Flutes	E.D.P. Numbers							Dimensions			Std . Pack.
	NC UNC	NF UNF		GT3	GT4	GT5	GT6	GT7	GT8	GT9	Overall Length	Length of Thread	Shank Dia.	
MACHINE SCREW SIZES														
2	56	64	3	96597	—	—	—	—	—	—	1 3/4	0.437	0.141	3
			3	96598	—	—	—	—	—	—	1 3/4	0.437	0.141	3
3	48	56	3	—	96599	—	—	—	—	—	1 13/16	0.500	0.141	3
			3	96600	—	—	—	—	—	—	1 13/16	0.500	0.141	3
4	40	48	3	—	—	96601	—	—	—	—	1 7/8	0.236	0.141	3
			3	—	96602	—	—	—	—	—	1 7/8	0.236	0.141	3
5	40	44	3	—	—	96603	—	—	—	—	1 15/16	0.236	0.141	3
			3	—	—	96604	—	—	—	—	1 15/16	0.236	0.141	3
6	32	40	3	—	—	96605	—	—	—	—	2	0.276	0.141	3
			3	—	—	96606	—	—	—	—	2	0.276	0.141	3
8	32	36	3	—	—	96607	—	—	—	—	2 1/8	0.276	0.168	3
			3	—	—	96608	—	—	—	—	2 1/8	0.276	0.168	3
10	24	32	3	—	—	—	96609	—	—	—	2 3/8	0.354	0.194	3
			3	—	—	96610	—	—	—	—	2 3/8	0.354	0.194	3
12	24	28	3	—	—	—	96611	—	—	—	2 3/8	0.354	0.220	3
			3	—	—	—	96612	—	—	—	2 3/8	0.354	0.220	3
FRACTIONAL SIZES														
1/4	20	28	3	—	—	—	—	96613	—	—	2 1/2	0.433	0.255	3
			3	—	—	—	96614	—	—	—	2 1/2	0.433	0.255	3
5/16	18	24	3	—	—	—	—	96615	—	—	2 23/32	0.472	0.318	3
			3	—	—	—	—	96616	—	—	2 23/32	0.472	0.318	3
3/8	16	24	3	—	—	—	—	—	96617	—	2 15/16	0.551	0.381	3
			3	—	—	—	—	—	96618	—	2 15/16	0.551	0.381	3
7/16	14	20	3	—	—	—	—	—	96619	—	3 5/32	0.709	0.323	3
			3	—	—	—	—	—	96620	—	3 5/32	0.709	0.323	3
1/2	13	20	3	—	—	—	—	—	96621	—	3 3/8	0.787	0.367	3
			3	—	—	—	—	—	96622	—	3 3/8	0.787	0.367	3
9/16	12	18	3	—	—	—	—	—	96623	—	3 19/32	0.827	0.429	3
			3	—	—	—	—	—	96624	—	3 19/32	0.827	0.429	3
5/8	11	18	3	—	—	—	—	—	—	96625	3 13/16	0.905	0.480	3
			3	—	—	—	—	—	96626	—	3 13/16	0.905	0.480	3
3/4	10	16	3	—	—	—	—	—	—	96627	4 1/4	0.984	0.590	3
			3	—	—	—	—	—	96628	—	4 1/4	0.984	0.590	3
7/8	9	14	4	—	—	—	—	—	—	96629	4 11/16	1.102	0.697	3
			4	—	—	—	—	—	—	96630	4 11/16	1.102	0.697	3
1	8	12	4	—	—	—	—	—	—	96631	5 1/8	1.260	0.800	3
			4	—	—	—	—	—	—	96632	5 1/8	1.260	0.800	3

Technical Data

DRILLS

DRILLS Cutting Condition

END MILLS

END MILLS Cutting Condition

TAPS

TAPS Cutting Condition

Others

List No.7977

COBALT/VANADIUM HIGH SPEED STEEL HSS



Plug Style, 4 To 5 Thread Lead
Surface Treated

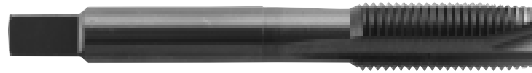

*GT to H-limit conversion chart refer to Page:270

Nominal Size	Thread/Inch		No. of Flutes	E.D.P. Numbers							Dimensions			Std . Pack.		
	NC UNC	NF UNF		GT3	GT4	GT5	GT6	GT7	GT8	GT9	Overall Length	Length of Thread	Shank Dia.			
MACHINE SCREW SIZES																
2	56		2	95597	—	—	—	—	—	—	1 3/4	0.437	0.141	3		
		64	2	95598	—	—	—	—	—	—	1 3/4	0.437	0.141	3		
3	48		2	—	95599	—	—	—	—	—	1 13/16	0.500	0.141	3		
		56	2	95600	—	—	—	—	—	—	1 13/16	0.500	0.141	3		
4	40		2	—	—	95601	—	—	—	—	1 7/8	0.354	0.141	3		
		48	2	—	95602	—	—	—	—	—	1 7/8	0.354	0.141	3		
5	40		3	—	—	95603	—	—	—	—	1 15/16	0.394	0.141	3		
		44	3	—	—	95604	—	—	—	—	1 15/16	0.394	0.141	3		
6	32		3	—	—	95605	—	—	—	—	2	0.433	0.141	3		
		40	3	—	—	95606	—	—	—	—	2	0.433	0.141	3		
8	32		3	—	—	95607	—	—	—	—	2 1/8	0.472	0.168	3		
		36	3	—	—	95608	—	—	—	—	2 1/8	0.472	0.168	3		
10	24		3	—	—	—	95609	—	—	—	2 3/8	0.551	0.194	3		
		32	3	—	—	95610	—	—	—	—	2 3/8	0.551	0.194	3		
12	24		3	—	—	—	95611	—	—	—	2 3/8	0.551	0.220	3		
		28	3	—	—	—	95612	—	—	—	2 3/8	0.551	0.220	3		
FRACTIONAL SIZES																
1/4	20		3	—	—	—	—	95613	—	—	2 1/2	0.591	0.255	3		
		28	3	—	—	—	95614	—	—	—	2 1/2	0.591	0.255	3		
5/16	18		3	—	—	—	—	95615	—	—	2 23/32	0.669	0.318	3		
		24	3	—	—	—	—	95616	—	—	2 23/32	0.669	0.318	3		
3/8	16		3	—	—	—	—	—	95617	—	2 15/16	0.748	0.381	3		
		24	3	—	—	—	—	—	95618	—	2 15/16	0.748	0.381	3		
7/16	14		3	—	—	—	—	—	95619	—	3 5/32	0.984	0.323	3		
		20	3	—	—	—	—	—	95620	—	3 5/32	0.984	0.323	3		
1/2	13		3	—	—	—	—	—	—	95621	—	3 3/8	1.142	0.367	3	
		20	3	—	—	—	—	—	—	95622	—	3 3/8	1.142	0.367	3	
9/16	12		3	—	—	—	—	—	—	95623	—	3 19/32	1.181	0.429	3	
		18	3	—	—	—	—	—	—	95624	—	3 19/32	1.181	0.429	3	
5/8	11		3	—	—	—	—	—	—	—	95625	3 13/16	1.260	0.480	3	
		18	3	—	—	—	—	—	—	—	95626	3 13/16	1.260	0.480	3	
3/4	10		3	—	—	—	—	—	—	—	95627	4 1/4	1.457	0.590	3	
		16	3	—	—	—	—	—	—	—	95628	4 1/4	1.457	0.590	3	
7/8	9		3	—	—	—	—	—	—	—	—	95629	4 11/16	1.496	0.697	3
		14	4	—	—	—	—	—	—	—	—	95630	4 11/16	1.496	0.697	3
1	8		3	—	—	—	—	—	—	—	—	95631	5 1/8	1.772	0.800	3
		12	4	—	—	—	—	—	—	—	—	95632	5 1/8	1.772	0.800	3

Technical Data

DRILLS

DRILLS
Cutting Condition

END MILLS

END MILLS
Cutting Condition

TAPS

TAPS
Cutting Condition

Others

VIPER T SERIES METRIC TAPS / FOR STAINLESS STEEL

Technical Data

DRILLS

DRILLS Cutting Condition

END MILLS

END MILLS Cutting Condition

TAPS

TAPS Cutting Condition

Others

List No.7982 Spiral Fluted

COBALT/VANADIUM HIGH SPEED STEEL



Modified Bottoming Style 2 1/2 To 3 Thread Lead
Surface Treated



*GT to H-limit conversion chart refer to Page:270

Nominal Size (mm)	Pitch (mm)	No. Of Flutes	E.D.P. Number					Dimensions			Std. Pack.
			GT5	GT6	GT7	GT8	GT9	Overall Length	Length of Thread	Shank Dia.	
METRIC											
3	0.5	3	56615	—	—	—	—	1 15/16	0.236	0.141	3
3.5	0.6	3	56616	—	—	—	—	2	0.276	0.141	3
4	0.7	3	56617	—	—	—	—	2 1/8	0.276	0.168	3
5	0.8	3	—	56619	—	—	—	2 3/8	0.354	0.194	3
6	1	3	—	56620	—	—	—	2 1/2	0.433	0.255	3
7	1	3	—	56621	—	—	—	2 23/32	0.472	0.318	3
8	1	3	—	56622	—	—	—	2 23/32	0.472	0.318	3
8	1.25	3	—	56623	—	—	—	2 23/32	0.472	0.318	3
10	1.25	3	—	56624	—	—	—	2 15/16	0.551	0.381	3
10	1.5	3	—	—	56625	—	—	2 15/16	0.551	0.381	3
12	1.25	3	—	—	—	56626	—	3 3/8	0.669	0.367	3
12	1.75	3	—	—	—	56627	—	3 3/8	0.669	0.367	3
14	1.5	3	—	—	—	56628	—	3 19/32	0.787	0.429	3
14	2	3	—	—	—	56629	—	3 19/32	0.787	0.429	3
16	1.5	3	—	—	—	56630	—	3 13/16	0.787	0.480	3
16	2	3	—	—	—	56631	—	3 13/16	0.787	0.480	3
18	1.5	4	—	—	—	56632	—	4 1/32	0.984	0.542	3
18	2.5	4	—	—	—	—	56633	4 1/32	0.984	0.542	3
20	1.5	4	—	—	—	56634	—	4 15/32	0.984	0.652	3
20	2.5	4	—	—	—	—	56635	4 15/32	0.984	0.652	3
22	1.5	4	—	—	—	56636	—	4 11/16	0.984	0.697	3
22	2.5	4	—	—	—	—	56637	4 11/16	0.984	0.697	3
24	1.5	4	—	—	—	56638	—	4 29/32	1.181	0.760	3
24	3	4	—	—	—	—	56639	4 29/32	1.181	0.760	3

List No.7972 Spiral Pointed

COBALT/VANADIUM HIGH SPEED STEEL HSSE



Plug Style, 4 To 5 Thread Lead
Surface Treated

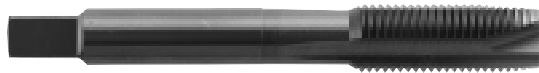

*GT to H-limit conversion chart refer to Page:270

Nominal Size (mm)	Pitch (mm)	No. Of Flutes	E.D.P. Number					Dimensions			Std. Pack.
			GT5	GT6	GT7	GT8	GT9	Overall Length	Length of Thread	Shank Dia.	
METRIC											
3	0.5	3	55615	—	—	—	—	1 15/16	0.394	0.141	3
3.5	0.6	3	55616	—	—	—	—	2	0.433	0.141	3
4	0.7	3	55617	—	—	—	—	2 1/8	0.472	0.168	3
5	0.8	3	—	55619	—	—	—	2 3/8	0.551	0.194	3
6	1	3	—	55620	—	—	—	2 1/2	0.591	0.255	3
7	1	3	—	55621	—	—	—	2 23/32	0.669	0.318	3
8	1	3	—	55622	—	—	—	2 23/32	0.669	0.318	3
8	1.25	3	—	55623	—	—	—	2 23/32	0.669	0.318	3
10	1.25	3	—	55624	—	—	—	2 15/16	0.748	0.381	3
10	1.5	3	—	—	55625	—	—	2 15/16	0.748	0.381	3
12	1.25	3	—	—	—	55626	—	3 3/8	1.141	0.367	3
12	1.75	3	—	—	—	55627	—	3 3/8	1.141	0.367	3
14	1.5	3	—	—	—	55628	—	3 19/32	1.181	0.429	3
14	2	3	—	—	—	55629	—	3 19/32	1.181	0.429	3
16	1.5	3	—	—	—	55630	—	3 13/16	1.260	0.480	3
16	2	3	—	—	—	55631	—	3 13/16	1.260	0.480	3
18	1.5	3	—	—	—	55632	—	4 1/32	1.457	0.542	3
18	2.5	3	—	—	—	—	55633	4 1/32	1.457	0.542	3
20	1.5	3	—	—	—	55634	—	4 15/32	1.457	0.652	3
20	2.5	3	—	—	—	—	55635	4 15/32	1.457	0.652	3
22	1.5	4	—	—	—	55636	—	4 11/16	1.496	0.697	3
22	2.5	3	—	—	—	—	55637	4 11/16	1.496	0.697	3
24	1.5	4	—	—	—	55638	—	4 29/32	1.772	0.760	3
24	3	3	—	—	—	—	55639	4 29/32	1.772	0.760	3

Taflet Taps for economical and efficient thread forming

NACHI Viper Taflet taps are designed for economical and efficient tapping of steel. No chips are produced with Taflet taps. The threads are formed by displacement of the metal. Threads produced this way are generally more accurate and stronger than threads produced by conventional tapping.

Advantages of NACHI Viper Taflet Taps

Conventional coldform taps for steel require high torque. NACHI Viper Taflet taps have been specially engineered for steels and require less torque, reducing the chance of breaking.

In conventional coldform threading, rapid wear and adhesion due to high frictional heat may occur. NACHI Viper Taflet tap's steam oxide surface treatment limits adhesion from fusion and carries coolant to the work area. Bright finish is also available when required.

Conventional coldform internal threads aren't always clean and accurate. NACHI Viper Taflet taps have more radial sections for higher accuracy of internal threads in steel.



Technical Data

DRILLS

DRILLS
Cutting Condition

END MILLS

END MILLS
Cutting Condition

TAPS

TAPS
Cutting Condition

Others

List No.995 Machine Screw Sizes

VANADIUM HIGH SPEED STEEL HSSE-V



Plug & Bottoming Style
Surface Treated



Nominal Size	Thread/Inch		Chamfer Style*	E.D.P. Numbers						Dimensions			Std. Pack.
	NC UNC	NF UNF		H2	H3	H4	H5	H6	H10	Overall Length	Length of Thread	Shank Dia.	
0		80	B	77732	—	—	—	—	—	1 5/8	0.311	0.141	3
1	64	72	B	77734	—	—	—	—	—	1 11/16	0.374	0.141	3
			B	77736	—	—	—	—	—	1 11/16	0.374	0.141	3
2	56	64	B	77738	77776	—	—	—	—	1 3/4	0.437	0.141	3
			B	77740	77778	—	—	—	—	1 3/4	0.437	0.141	3
3	48	56	B	77742	77780	—	—	—	—	1 13/16	0.500	0.141	3
			B	—	77782	—	—	—	—	1 13/16	0.500	0.141	3
4	40	48	P	—	77783	—	77856	—	—	1 7/8	0.354	0.141	3
			B	—	77784	—	77857	—	—	1 7/8	0.354	0.141	3
			P	—	77785	—	77858	—	—	1 7/8	0.354	0.141	3
			B	—	77786	—	77859	—	—	1 7/8	0.354	0.141	3
5	40	44	P	—	77787	—	77860	—	—	1 15/16	0.394	0.141	3
			B	—	77788	—	77861	—	—	1 15/16	0.394	0.141	3
			P	—	77789	—	77862	—	—	1 15/16	0.394	0.141	3
			B	—	77790	—	77863	—	—	1 15/16	0.394	0.141	3
6	32	40	P	—	77791	—	77864	—	77970	2	0.433	0.141	3
			B	—	77792	—	77865	—	77971	2	0.433	0.141	3
			P	—	77793	—	77866	—	—	2	0.433	0.141	3
			B	—	77794	—	77867	—	—	2	0.433	0.141	3
8	32	36	P	—	77795	—	77868	—	77972	2 1/8	0.472	0.168	3
			B	—	77796	—	77869	—	77973	2 1/8	0.472	0.168	3
			P	—	77797	—	77870	—	—	2 1/8	0.472	0.168	3
			B	—	77798	—	77871	—	—	2 1/8	0.472	0.168	3
10	24	32	P	—	—	77829	—	77903	77974	2 3/8	0.551	0.194	3
			B	—	—	77830	—	77904	77975	2 3/8	0.551	0.194	3
			P	—	—	77831	—	77905	77976	2 3/8	0.551	0.194	3
			B	—	—	77832	—	77906	77977	2 3/8	0.551	0.194	3
12	24	28	P	—	—	77833	—	77907	—	2 3/8	0.551	0.220	3
			B	—	—	77834	—	77908	—	2 3/8	0.551	0.220	3
			P	—	—	77835	—	77909	—	2 3/8	0.551	0.220	3
			B	—	—	77836	—	77910	—	2 3/8	0.551	0.220	3

* P : Plug, B : Bottom

Technical Data

DRILLS

DRILLS Cutting Condition

END MILLS

END MILLS Cutting Condition

TAPS

TAPS Cutting Condition

Others

List No.995 Fractional Sizes

VANADIUM HIGH SPEED STEEL HSSE-V



Plug & Bottoming Style
Surface Treated



Nominal Size	Thread/Inch		Chamfer Style*	E.D.P. Numbers						Dimensions			Std . Pack.	
	NC UNC	NF UNF		H4	H5	H6	H7	H8	H10	Overall Length	Length of Thread	Shank Dia.		
1/4	20		P	77837	—	77911	—	—	77978	2 1/2	0.591	0.255	3	
			B	77838	—	77912	—	—	77979	2 1/2	0.591	0.255	3	
	28		P	77839	—	77913	—	—	77980	2 1/2	0.591	0.255	3	
			B	77840	—	77914	—	—	77981	2 1/2	0.591	0.255	3	
5/16	18		P	—	77872	—	77930	—	—	2 23/32	0.669	0.318	3	
			B	—	77873	—	77931	—	—	2 23/32	0.669	0.318	3	
			24	P	—	77874	—	77932	—	—	2 23/32	0.669	0.318	3
				B	—	77875	—	77933	—	—	2 23/32	0.669	0.318	3
3/8	16		P	—	77876	—	77934	—	—	2 15/16	0.748	0.381	3	
			B	—	77877	—	77935	—	—	2 15/16	0.748	0.381	3	
			24	P	—	77878	—	77936	—	—	2 15/16	0.748	0.381	3
				B	—	77879	—	77937	—	—	2 15/16	0.748	0.381	3
7/16	14		P	—	77880	—	—	77960	—	3 5/32	0.866	0.323	3	
			B	—	77881	—	—	77961	—	3 5/32	0.866	0.323	3	
			20	P	—	77882	—	—	77962	—	3 5/32	0.866	0.323	3
				B	—	77883	—	—	77963	—	3 5/32	0.866	0.323	3
1/2	13		P	—	77884	—	—	77964	—	3 3/8	0.984	0.367	3	
			B	—	77885	—	—	77965	—	3 3/8	0.984	0.367	3	
			20	P	—	77886	—	—	77966	—	3 3/8	0.984	0.367	3
				B	—	77887	—	—	77967	—	3 3/8	0.984	0.367	3
9/16	12		P	—	—	—	77946	—	77990	3 19/32	0.984	0.429	3	
			B	—	—	—	77947	—	77991	3 19/32	0.984	0.429	3	
			18	P	—	—	—	77948	—	77992	3 19/32	0.984	0.429	3
				B	—	—	—	77949	—	77993	3 19/32	0.984	0.429	3
5/8	11		P	—	—	—	77950	—	77994	3 13/16	1.102	0.480	3	
			B	—	—	—	77951	—	77995	3 13/16	1.102	0.480	3	
			18	P	—	—	—	77952	—	77996	3 13/16	1.102	0.480	3
				B	—	—	—	77953	—	77997	3 13/16	1.102	0.480	3
3/4	10		P	—	—	—	77954	—	77998	4 1/4	1.181	0.590	3	
			B	—	—	—	77955	—	77999	4 1/4	1.181	0.590	3	
			16	P	—	—	—	77956	—	78000	4 1/4	1.181	0.590	3
				B	—	—	—	77957	—	78001	4 1/4	1.181	0.590	3

* P : Plug, B : Bottom

Technical Data

DRILLS

DRILLS
Cutting Condition

END MILLS

END MILLS
Cutting Condition

TAPS

TAPS
Cutting Condition

Others

VIPER TAFLET METRIC TAPS FOR STEELS

List No.996 Metric Sizes

VANADIUM HIGH SPEED STEEL HSSE-V



Plug & Bottoming Style
Surface Treated



Nominal Size (mm)	Pitch (mm)	Chamfer Style*	E.D.P. Numbers									Dimensions			Std. Pack.	
			D3	D4	D5	D6	D7	D8	D9	D10	D11	Overall Length	Length of Thread	Shank Dia.		
2	0.4	P	51001	—	—	—	—	—	—	—	—	—	1 3/4	0.437	0.119	3
		B	51002	—	—	—	—	—	—	—	—	—	1 3/4	0.437	0.119	3
2.2	0.45	P	51004	—	—	—	—	—	—	—	—	—	1 3/4	0.437	0.119	3
		B	51005	—	—	—	—	—	—	—	—	—	1 3/4	0.437	0.119	3
2.5	0.45	P	51007	—	—	—	—	—	—	—	—	—	1 13/16	0.500	0.119	3
		B	51008	—	—	—	—	—	—	—	—	—	1 13/16	0.500	0.119	3
3	0.5	P	51010	—	—	—	—	—	—	—	—	—	1 15/16	0.394	0.141	3
		B	51011	—	—	—	—	—	—	—	—	—	1 15/16	0.394	0.141	3
3.5	0.6	P	51013	—	—	—	—	—	—	—	—	—	2	0.433	0.141	3
		B	51014	—	—	—	—	—	—	—	—	—	2	0.433	0.141	3
4	0.7	P	—	51016	—	—	—	—	—	—	—	—	2 1/8	0.472	0.168	3
		B	—	51017	—	—	—	—	—	—	—	—	2 1/8	0.472	0.168	3
4.5	0.75	P	—	51019	—	—	—	—	—	—	—	—	2 3/8	0.551	0.184	3
		B	—	51020	—	—	—	—	—	—	—	—	2 3/8	0.551	0.184	3
5	0.8	P	—	51022	—	—	—	—	—	—	—	—	2 3/8	0.551	0.194	3
		B	—	51023	—	—	—	—	—	—	—	—	2 3/8	0.551	0.194	3
6	1	P	—	—	51025	—	—	—	—	—	—	—	2 1/2	0.591	0.255	3
		B	—	—	51026	—	—	—	—	—	—	—	2 1/2	0.591	0.255	3
7	1	P	—	—	—	51028	—	—	—	—	—	—	2 23/32	0.669	0.318	3
		B	—	—	—	51029	—	—	—	—	—	—	2 23/32	0.669	0.318	3
8	1	P	—	—	51031	—	—	—	—	—	—	—	2 23/32	0.669	0.318	3
		B	—	—	51032	—	—	—	—	—	—	—	2 23/32	0.669	0.318	3
	1.25	P	—	—	—	—	—	51034	—	—	—	—	2 23/32	0.669	0.318	3
		B	—	—	—	—	—	51035	—	—	—	—	2 23/32	0.669	0.318	3
10	1.25	P	—	—	—	—	—	51037	—	—	—	—	2 15/16	0.748	0.381	3
		B	—	—	—	—	—	51038	—	—	—	—	2 15/16	0.748	0.381	3
	1.50	P	—	—	—	—	—	—	51040	—	—	—	2 15/16	0.748	0.381	3
		B	—	—	—	—	—	—	51041	—	—	—	2 15/16	0.748	0.381	3
12	1.25	P	—	—	—	—	—	—	51043	—	—	—	3 3/8	0.984	0.367	3
		B	—	—	—	—	—	—	51044	—	—	—	3 3/8	0.984	0.367	3
	1.75	P	—	—	—	—	—	—	—	51046	—	—	3 3/8	0.984	0.367	3
		B	—	—	—	—	—	—	—	51047	—	—	3 3/8	0.984	0.367	3
14	1.5	P	—	—	—	—	—	—	—	51049	—	—	3 19/32	0.984	0.429	3
		B	—	—	—	—	—	—	—	51050	—	—	3 19/32	0.984	0.429	3
	2	P	—	—	—	—	—	—	—	—	51052	—	3 19/32	0.984	0.429	3
		B	—	—	—	—	—	—	—	—	51053	—	3 19/32	0.984	0.429	3
16	1.5	P	—	—	—	—	—	—	—	51055	—	—	3 13/16	1.102	0.480	3
		B	—	—	—	—	—	—	—	51056	—	—	3 13/16	1.102	0.480	3
	2	P	—	—	—	—	—	—	—	—	51058	—	3 13/16	1.102	0.480	3
		B	—	—	—	—	—	—	—	—	51059	—	3 13/16	1.102	0.480	3
18	1.5	P	—	—	—	—	—	—	—	51061	—	—	4 1/32	1.102	0.542	3
		B	—	—	—	—	—	—	—	51062	—	—	4 1/32	1.102	0.542	3
	2.5	P	—	—	—	—	—	—	—	—	51064	—	4 1/32	1.102	0.542	3
		B	—	—	—	—	—	—	—	—	51065	—	4 1/32	1.102	0.542	3
20	1.5	P	—	—	—	—	—	—	—	51067	—	—	4 15/32	1.181	0.652	3
		B	—	—	—	—	—	—	—	51068	—	—	4 15/32	1.181	0.652	3
	2.5	P	—	—	—	—	—	—	—	—	51070	—	4 15/32	1.181	0.652	3
		B	—	—	—	—	—	—	—	—	51071	—	4 15/32	1.181	0.652	3

* P : Plug, B : Bottom

Taflet Taps

Nom. Dia	Threads/Inch		Basic Major Dia.	75%		65%		55%	
	NC UNC	NF UNF		Theoretical Core Hole	Nearest Drill Dia.	Theoretical Core Hole	Nearest Drill Dia.	Theoretical Core Hole	Nearest Drill Dia.
0		80	.0600	.0536	1.35mm	.0545	—	.0553	#54
1	64		.0730	.0650	1.65mm	.0661	—	.0672	#51
		72	.0730	.0659	1.65mm	.0669	1.7mm	.0679	#51
2	56		.0860	.0769	1.95mm	.0781	5/64	.0794	2.0mm
		64	.0860	.0780	5/64	.0791	2.0mm	.0802	—
3	48		.0990	.0884	2.25mm	.0898	#43	.0913	2.3mm
		56	.0990	.0899	#43	.0911	2.3mm	.0924	2.35mm
4	40		.1120	.0993	2.5mm	.1010	#39	.1027	2.6mm
		48	.1120	.1014	#38	.1028	2.6mm	.1166	#37
5	40		.1250	.1123	#34	.1140	#33	.1157	#32
		44	.1250	.1134	#33	.1150	2.9mm	.1166	#32
6	32		.1380	.1221	3.1mm	.1242	—	.1263	3.2mm
		40	.1380	.1253	1/8	.1270	3.2mm	.1287	#30
8	32		.1640	.1481	3.7mm	.1502	#25	.1523	#24
		36	.1640	.1498	#25	.1517	#24	.1537	3.9mm
10	24		.1900	.1688	—	.1716	11/64	.1746	#17
		32	.1900	.1741	#17	.1762	—	.1784	4.5mm
12	24		.2160	.1948	#10	.1976	5.0mm	.2006	5.1mm
		28	.2160	.1978	5.0mm	.2002	#8	.2028	—
1/4	20		.2500	.2245	5.7mm	.2280	#1	.2315	—
		28	.2500	.2318	—	.2342	A	.2368	6.0mm
5/16	18		.3125	.2842	7.2mm	.2879	7.3mm	.2917	7.4mm
		24	.3125	.2913	7.4mm	.2941	M	.2969	19/64
3/8	16		.3750	.3431	11/32	.3474	S	.3516	—
		24	.3750	.3538	9.0mm	.3566	—	.3594	23/64
7/16	14		.4375	.4011	—	.4059	13/32	.4108	—
		20	.4375	.4120	#2	.4154	—	.4188	—
1/2	13		.5000	.4608	—	.4660	—	.4712	12mm
		20	.5000	.4745	—	.4779	—	.4813	—
9/16	12		.5625	.5200	—	.5257	—	.5313	17/32
		18	.5625	.5342	13.5mm	.5379	—	.5417	—
5/8	11		.6250	.5787	37/64	.5848	37/64	.5910	15mm
		18	.6250	.5967	19/32	.6004	—	.6042	—
3/4	10		.7500	.6990	—	.7058	45/64	.7126	—
		16	.7500	.7181	23/32	.7224	—	.7266	—

Nom. Dia	Pitch	Theoretical Core Hole Size						Suggested	Taps
		Min.		Max.					
		Inches	mm	5H Class		6H Class			
				Inches	mm	Inches	mm		
3	0.5	.1071	2.72	.1094	2.79	.1098	2.79	H5	H6
3.5	0.6	.1244	3.16	.1268	3.22	.1276	3.24	H5	H7
4	0.7	.1417	3.60	.1445	3.67	.1453	3.69	H6	H7
5	0.8	.1791	4.55	.1823	4.63	.1831	4.65	H6	H8
6	1	.2142	5.44	.2177	5.53	.2185	5.55	H7	H9
8	1.25	.2870	7.29	.2913	7.40	.2925	7.43	H8	H10
10	1.5	.3602	9.15	.3602	9.27	.3665	9.31	H9	H11
12	1.75	.4335	11.01	.4368	11.14	.4402	11.18	H10	H12
14	2	.5067	12.87	.5126	13.02	.5142	13.06	H11	H13
16	2	.5854	14.87	.5913	15.02	.5929	15.06	H11	H13
20	2.5	.7315	18.58	.7386	18.76	.7409	18.82	H11	H14

Technical Data

DRILLS

DRILLS
Cutting Condition

END MILLS

END MILLS
Cutting Condition

TAPS

TAPS
Cutting Condition

Others

VTP SPIRAL FLUTED

Technical Data

List No.983 Machine Screw Sizes



Modified Bottoming Style 2-1/2 To 3 Thread Lead
Surface Treated

VANADIUM HIGH SPEED STEEL HSSE-V



DRILLS

DRILLS Cutting Condition

Nominal Size	Thread/Inch		No. of Flutes	E.D.P. Numbers						Dimensions			Std. Pack.
	NC UNC	NF UNF		H2	H3	H4	H5	H6	H7	Overall Length	Length of Thread	Shank Dia.	
2	56		2	88239	—	—	—	—	—	1 3/4	0.433	0.141	3
3	48		2	88240	—	—	—	—	—	1 13/16	0.500	0.141	3
4	40		2	88241	88242	88243	—	—	—	1 7/8	0.236	0.141	3
5	40		3	88253	—	—	—	—	—	1 15/16	0.236	0.141	3
6	32		3	—	88263	88264	88265	88266	88267	2	0.276	0.141	3
8	32		3	—	88277	88278	88279	88280	88281	2 1/8	0.276	0.168	3
10	24		3	—	88291	—	88292	88293	88294	2 3/8	0.354	0.194	3
		32	3	—	88299	88300	88301	—	88303	2 3/8	0.354	0.194	3

END MILLS

END MILLS Cutting Condition

List No.981 Fractional Sizes



Modified Bottoming Style 2-1/2 To 3 Thread Lead
Surface Treated

VANADIUM HIGH SPEED STEEL HSSE-V



Nominal Size	Thread/Inch		No. of Flutes	E.D.P. Numbers						Dimensions			Std. Pack.
	NC UNC	NF UNF		H2	H3	H4	H5	H6	H7	Overall Length	Length of Thread	Shank Dia.	
1/4	20		3	—	88057	—	88060	—	88062	2 1/2	0.433	0.255	3
		28	3	—	88071	88072	88073	88074	88075	2 1/2	0.433	0.255	3
5/16	18		3	—	88081	—	88083	—	88085	2 23/32	0.472	0.318	3
		24	3	—	88095	88096	88097	—	88098	2 23/32	0.472	0.318	3
3/8	16		3	—	88103	—	88105	—	88107	2 15/16	0.551	0.381	3
		24	3	—	88111	88112	88113	—	88115	2 15/16	0.551	0.381	3
7/16	14		3	—	88117	—	88119	—	—	3 5/32	0.591	0.323	3
		20	3	—	88123	—	88125	—	—	3 5/32	0.591	0.323	3
1/2	13		3	—	88131	—	88133	—	88135	3 3/8	0.630	0.367	3
		20	3	—	88139	—	88141	—	—	3 3/8	0.630	0.367	3
9/16	12		3	—	88145	—	—	—	—	3 19/32	0.709	0.429	3
		18	3	—	88146	—	—	—	—	3 19/32	0.709	0.429	3
5/8	11		3	—	88149	—	88151	—	88153	3 13/16	0.748	0.480	3
		18	3	—	88157	—	88159	—	—	3 13/16	0.748	0.480	3
3/4	10		3	—	88167	—	—	—	88171	4 1/4	0.827	0.590	3
		16	3	—	88175	—	88177	—	—	4 1/4	0.827	0.590	3
7/8	9		4	—	88180	—	—	—	—	4 11/16	0.906	0.697	3
		14	4	—	88185	—	—	—	—	4 11/16	0.906	0.697	3
1	8		4	—	88190	—	—	—	—	5 1/8	0.984	0.800	3

TAPS

TAPS Cutting Condition

Others

List No.973 Machine Screw Sizes



Plug Style 4 to 5 Threads
Surface Treated

VANADIUM HIGH SPEED STEEL HSSE-V



Nominal Size	Thread/Inch		No. of Flutes	E.D.P. Numbers						Dimensions			Std. Pack.
	NC UNC	NF UNF		H2	H3	H4	H5	H6	H7	Overall Length	Length of Thread	Shank Dia.	
2	56		2	87216	87218	—	—	—	—	1 3/4	0.437	0.141	3
3	48		2	87220	—	—	—	—	—	1 13/16	0.500	0.141	3
4	40		2	87240	87242	87243	87244	—	—	1 7/8	0.354	0.141	3
5	40		2	87252	—	—	—	—	—	1 15/16	0.394	0.141	3
6	32		2	87258	87260	87261	87264	87265	87266	2	0.433	0.141	3
8	32		3	87272	87274	87275	87278	87279	87280	2 1/8	0.472	0.168	3
10	24		3	—	87288	—	87290	—	—	2 3/8	0.551	0.194	3
		32	3	87294	87296	87297	87300	87301	87302	2 3/8	0.551	0.194	3

List No.971 Fractional Sizes



Plug Style 4 to 5 Threads
Surface Treated

VANADIUM HIGH SPEED STEEL HSSE-V

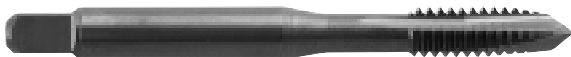

Nominal Size	Thread/Inch		No. of Flutes	E.D.P. Numbers						Dimensions			Std. Pack.
	NC UNC	NF UNF		H2	H3	H4	H5	H6	H7	Overall Length	Length of Thread	Shank Dia.	
1/4	20		3	87052	87056	—	87060	—	87062	2 1/2	0.591	0.255	3
		28	3	87066	87068	87070	87071	87072	87073	2 1/2	0.591	0.255	3
5/16	18		3	—	87080	—	87084	—	87086	2 23/32	0.669	0.318	3
		24	3	—	87094	87096	87097	87098	87099	2 23/32	0.669	0.318	3
3/8	16		3	—	87102	—	87104	—	87106	2 15/16	0.748	0.381	3
		24	3	—	87110	87112	87113	87114	87115	2 15/16	0.748	0.381	3
7/16	14		3	—	87116	—	87120	—	—	3 5/32	0.866	0.323	3
		20	3	—	87122	—	87126	87127	87129	3 5/32	0.866	0.323	3
1/2	13		3	—	87130	—	87134	—	87136	3 3/8	0.984	0.367	3
		20	3	—	87138	—	87140	87141	87142	3 3/8	0.984	0.367	3
9/16	12		3	—	87143	—	—	—	—	3 19/32	0.984	0.429	3
		18	3	—	87144	—	—	—	—	3 19/32	0.984	0.429	3
5/8	11		3	—	87148	—	87152	—	87154	3 13/16	1.102	0.480	3
		18	3	—	87158	—	87159	—	—	3 13/16	1.102	0.480	3
3/4	10		3	—	87164	—	—	—	87167	4 1/4	1.181	0.590	3
		16	3	—	87168	—	87169	—	—	4 1/4	1.181	0.590	3
7/8	9		3	—	87170	—	—	—	—	4 11/16	1.299	0.697	3
		14	3	—	87171	—	—	—	—	4 11/16	1.299	0.697	3
1	8		3	—	87172	—	—	—	—	5 1/8	1.378	0.800	3

Technical Data

DRILLS

DRILLS
Cutting Condition

END MILLS

END MILLS
Cutting Condition

TAPS

TAPS
Cutting Condition

Others

* **List No.993** Machine Screw Sizes

PREMIUM TYPE STEEL



Surface Treated



Nominal Size	Thread/Inch		Pitch Diameter Limits	E.D.P. Numbers		Dimensions			Std. Pack.
	NC UNC	NF UNF		Plug	Bottom	Overall Length	Length of Thread	Shank Dia.	
0		80	H2		82003	1 5/8	0.311	0.141	3
1	64		H2		82009	1 11/16	0.374	0.141	3
1		72	H2		82015	1 11/16	0.374	0.141	3
2	56		H2		82021	1 3/4	0.437	0.141	3
2	56		H3		82024	1 3/4	0.437	0.141	3
2		64	H2		82030	1 3/4	0.437	0.141	3
2		64	H3		82033	1 3/4	0.437	0.141	3
3	48		H2		82039	1 13/16	0.500	0.141	3
3	48		H3		82042	1 13/16	0.500	0.141	3
3		56	H2		82048	1 13/16	0.500	0.141	3
3		56	H3		82051	1 13/16	0.500	0.141	3
4	40		H3	82056	82057	1 7/8	0.354	0.141	3
4	40		H5	82062	82063	1 7/8	0.354	0.141	3
4		48	H3	82068	82069	1 7/8	0.354	0.141	3
4		48	H5	82074	82075	1 7/8	0.354	0.141	3
5	40		H3	82080	82081	1 15/16	0.394	0.141	3
5	40		H5	82086	82087	1 15/16	0.394	0.141	3
5		44	H3	82092	82093	1 15/16	0.394	0.141	3
5		44	H5	82098	82099	1 15/16	0.394	0.141	3
6	32		H3	82104	82105	2	0.433	0.141	3
6	32		H5	82110	82111	2	0.433	0.141	3
6	32		H10	82119	82120	2	0.433	0.141	3
6		40	H3	82122	82123	2	0.433	0.141	3
6		40	H5	82128	82129	2	0.433	0.141	3
8	32		H3	82140	82141	2 1/8	0.472	0.168	3
8	32		H5	82146	82147	2 1/8	0.472	0.168	3
8	32		H10	82152	82153	2 1/8	0.472	0.168	3
8		36	H3	82158	82159	2 1/8	0.472	0.168	3
8		36	H5	82164	82165	2 1/8	0.472	0.168	3
10	24		H4	82179	82180	2 3/8	0.551	0.194	3
10	24		H6	82185	82186	2 3/8	0.551	0.194	3
10	24		H10	82191	82192	2 3/8	0.551	0.194	3
10		32	H4	82200	82201	2 3/8	0.551	0.194	3
10		32	H6	82206	82207	2 3/8	0.551	0.194	3
10		32	H10	82212	82213	2 3/8	0.551	0.194	3
12	24		H4	82218	82219	2 3/8	0.551	0.220	3
12	24		H6	82224	82225	2 3/8	0.551	0.220	3
12		28	H4	82236	82237	2 3/8	0.551	0.220	3
12		28	H6	82242	82243	2 3/8	0.551	0.220	3

Roll thread forming taps designed with more lobes and lubrication grooves. The extra lobes and grooves reduce tapping torque by allowing more coolant to reach critical contact areas.

* item will be discontinued, after stock has depleted.

We recommend L995 Viper Taflet for Steels (Machine Screw Sizes) as substitution item for L993.

* **List No.991** Fractional Sizes

PREMIUM TYPE STEEL



Surface Treated



Nominal Size	Thread/Inch		Pitch Diameter Limits	E.D.P. Numbers		Dimensions			Std. Pack.
	NC UNC	NF UNF		Plug	Bottom	Overall Length	Length of Thread	Shank Dia.	
1/4	20		H4	82254	82255	2 1/2	0.591	0.255	3
1/4	20		H6	82260	82261	2 1/2	0.591	0.255	3
1/4	20		H10	82266	82267	2 1/2	0.591	0.255	3
1/4		28	H4	82272	82273	2 1/2	0.591	0.255	3
1/4		28	H6	82278	82279	2 1/2	0.591	0.255	3
1/4		28	H10	82284	82285	2 1/2	0.591	0.255	3
5/16	18		H5	82293	82294	2 23/32	0.669	0.318	3
5/16	18		H7	82299	82300	2 23/32	0.669	0.318	3
5/16		24	H5	82311	82312	2 23/32	0.669	0.318	3
5/16		24	H7	82317	82318	2 23/32	0.669	0.318	3
3/8	16		H5	82326	82327	2 15/16	0.748	0.381	3
3/8	16		H7	82332	82333	2 15/16	0.748	0.381	3
3/8		24	H5	82341	82342	2 15/16	0.748	0.381	3
3/8		24	H7	82347	82348	2 15/16	0.748	0.381	3
7/16	14		H5	82356	82357	3 5/32	0.866	0.323	3
7/16	14		H8	82365	82366	3 5/32	0.866	0.323	3
7/16		20	H5	82374	82375	3 5/32	0.866	0.323	3
7/16		20	H8	82383	82384	3 5/32	0.866	0.323	3
1/2	13		H5	82392	82393	3 3/8	0.984	0.367	3
1/2	13		H8	82401	82402	3 3/8	0.984	0.367	3
1/2		20	H5	82410	82411	3 3/8	0.984	0.367	3
1/2		20	H8	82419	82420	3 3/8	0.984	0.367	3
9/16	12		H7	82431	82432	3 19/32	0.984	0.429	3
9/16	12		H10	82437	82438	3 19/32	0.984	0.429	3
9/16		18	H7	82446	82447	3 19/32	0.984	0.429	3
9/16		18	H10	82452	82453	3 19/32	0.984	0.429	3
5/8	11		H7	82461	82462	3 13/16	1.102	0.480	3
5/8	11		H10	82467	82468	3 13/16	1.102	0.480	3
5/8		18	H7	82476	82477	3 13/16	1.102	0.480	3
5/8		18	H10	82482	82483	3 13/16	1.102	0.480	3
3/4	10		H7	82491	82492	4 1/4	1.181	0.590	3
3/4	10		H10	82497	82498	4 1/4	1.181	0.590	3
3/4		16	H7	82506	82507	4 1/4	1.181	0.590	3
3/4		16	H10	82512	82513	4 1/4	1.181	0.590	3

Roll thread forming taps designed with more lobes and lubrication grooves. The extra lobes and grooves reduce tapping torque by allowing more coolant to reach critical contact areas.

* item will be discontinued, after stock has depleted.

We recommend L995 Viper Tappet for Steels (Fractional Sizes) as substitution item for L991.

Technical Data

DRILLS

DRILLS
Cutting Condition

END MILLS

END MILLS
Cutting Condition

TAPS

TAPS
Cutting Condition

Others

VTP TAP BLANK DIMENSIONS

Nominal Size	Overall Length	Length of Thread			Square Length	Size of Square	Shank Diameter
		971-973	991-993	981-983			
0	1 5/8	0.311	0.311		3/16	0.110	0.141
1	1 11/16	0.374	0.374		3/16	0.110	0.141
2	1 3/4	0.437	0.437		3/16	0.110	0.141
3	1 13/16	0.500	0.500		3/16	0.110	0.141
4	1 7/8	0.354	0.354	0.236	3/16	0.110	0.141
5	1 15/16	0.394	0.394	0.236	3/16	0.110	0.141
6	2	0.433	0.433	0.276	3/16	0.110	0.141
8	2 1/8	0.472	0.472	0.276	3/16	0.131	0.168
10NC	2 3/8	0.551	0.551	0.354	1/4	0.152	0.194
10NF	2 3/8	0.551	0.551	0.354	1/4	0.152	0.194
12	2 3/8	0.551	0.551	0.354	9/32	0.165	0.220
1/4NC	2 1/2	0.591	0.591	0.433	5/16	0.191	0.255
1/4NF	2 1/2	0.591	0.591	0.433	5/16	0.191	0.255
5/16NC	2 23/32	0.669	0.669	0.472	3/8	0.238	0.318
5/16NF	2 23/32	0.669	0.669	0.472	3/8	0.238	0.318
3/8NC	2 15/16	0.748	0.748	0.551	7/16	0.286	0.381
3/8NF	2 15/16	0.748	0.748	0.551	7/16	0.286	0.381
7/16NC	3 5/32	0.866	0.866	0.591	13/32	0.242	0.323
7/16NF	3 5/32	0.866	0.866	0.591	13/32	0.242	0.323
1/2NC	3 3/8	0.984	0.984	0.630	7/16	0.275	0.367
1/2NF	3 3/8	0.984	0.984	0.630	7/16	0.275	0.367
9/16NC	3 19/32	0.984	0.984	0.709	1/2	0.322	0.429
9/16NF	3 19/32	0.984	0.984	0.709	1/2	0.322	0.429
5/8NC	3 13/16	1.102	1.102	0.748	9/16	0.360	0.480
5/8NF	3 13/16	1.102	1.102	0.748	9/16	0.360	0.480
3/4NC	4 1/4	1.181	1.181	0.827	11/64	0.441	0.590
3/4NF	4 1/4	1.181	1.181	0.827	11/64	0.441	0.590

VTP Taps are manufactured from premium type-High Vanadium High Speed Steel.

They have a High Vanadium content for superior wear resistance, and are specially heat-treated for toughness.

The black oxide surface treatment provides extra lubricity and resistance to galling pickup.

Tap geometry designed for optimum cutting performance and close control of tapped holes size.

Technical Data

DRILLS

DRILLS
Cutting Condition

END MILLS

END MILLS
Cutting Condition

TAPS

TAPS
Cutting Condition

Others

VTP METRIC TAPS SPIRAL FLUTED
VTP METRIC TAPS SPIRAL POINTED

List No.980 Spiral Fluted

VANADIUM HIGH SPEED STEEL HSSE-V



Modified Bottoming Style 2-1/2 To 3 Thread Lead
Surface Treated



Nominal Size (mm)	Pitch (mm)	No. Of Flutes	E.D.P. Number					Dimensions			Std. Pack.
			D3	D4	D5	D6	D7	Overall Length	Length of Thread	Shank Dia.	
3	0.5	3	54615	—	—	—	—	1 15/16	0.236	0.141	3
3.5	0.6	3	—	54616	—	—	—	2	0.276	0.141	3
4	0.7	3	—	54617	—	—	—	2 1/8	0.276	0.168	3
5	0.8	3	—	54619	—	—	—	2 3/8	0.354	0.194	3
6	1	3	—	—	54620	—	—	2 1/2	0.433	0.255	3
7	1	3	—	—	54621	—	—	2 23/32	0.472	0.318	3
8	1	3	—	—	54622	—	—	2 23/32	0.472	0.318	3
8	1.25	3	—	—	54623	—	—	2 23/32	0.472	0.318	3
10	1.25	3	—	—	54624	—	—	2 15/16	0.551	0.381	3
10	1.5	3	—	—	—	54625	—	2 15/16	0.551	0.381	3
12	1.25	3	—	—	54626	—	—	3 3/8	0.630	0.367	3
12	1.75	3	—	—	—	54627	—	3 3/8	0.630	0.367	3
14	1.5	3	—	—	—	54628	—	3 19/32	0.551	0.429	3
14	2	3	—	—	—	—	54629	3 19/32	0.709	0.429	3
16	1.5	3	—	—	—	54630	—	3 13/16	0.551	0.480	3
16	2	3	—	—	—	—	54631	3 13/16	0.709	0.480	3
18	1.5	3	—	—	—	54632	—	4 1/32	0.551	0.542	3
18	2.5	3	—	—	—	—	54633	4 1/32	0.874	0.542	3

List No.982 Spiral Pointed

VANADIUM HIGH SPEED STEEL HSSE-V



Plug Style, 4 To 5 Thread Lead
Surface Treated



Nominal Size (mm)	Pitch (mm)	No. Of Flutes	E.D.P. Number					Dimensions			Std. Pack.
			D3	D4	D5	D6	D7	Overall Length	Length of Thread	Shank Dia.	
3	0.5	3	52615	—	—	—	—	1 15/16	0.394	0.141	3
3.5	0.6	3	—	52616	—	—	—	2	0.433	0.141	3
4	0.7	3	—	52617	—	—	—	2 1/8	0.472	0.168	3
5	0.8	3	—	52619	—	—	—	2 3/8	0.551	0.194	3
6	1	3	—	—	52620	—	—	2 1/2	0.591	0.255	3
7	1	3	—	—	52621	—	—	2 23/32	0.669	0.318	3
8	1	3	—	—	52622	—	—	2 23/32	0.669	0.318	3
8	1.25	3	—	—	52623	—	—	2 23/32	0.669	0.318	3
10	1.25	3	—	—	52624	—	—	2 15/16	0.748	0.381	3
10	1.5	3	—	—	—	52625	—	2 15/16	0.748	0.381	3
12	1.25	3	—	—	52626	—	—	3 3/8	0.984	0.367	3
12	1.75	3	—	—	—	52627	—	3 3/8	0.984	0.367	3
14	1.5	3	—	—	—	52628	—	3 19/32	0.984	0.429	3
14	2	3	—	—	—	—	52629	3 19/32	0.984	0.429	3
16	1.5	3	—	—	—	52630	—	3 13/16	1.102	0.480	3
16	2	3	—	—	—	—	52631	3 13/16	1.102	0.480	3
18	1.5	3	—	—	—	52632	—	4 1/32	1.102	0.542	3
18	2.5	3	—	—	—	—	52633	4 1/32	1.102	0.542	3

Technical Data

DRILLS

DRILLS
Cutting Condition

END MILLS

END MILLS
Cutting Condition

TAPS

TAPS
Cutting Condition

Others

STANDARD HAND TAPS

Technical Data

DRILLS

DRILLS Cutting Condition

END MILLS

END MILLS Cutting Condition

TAPS

TAPS Cutting Condition

Others

List No.911 Fractional Sizes



Bright Finish

HIGH SPEED STEEL



List No.911P Fractional Sizes



Titanium Nitride Coated

HIGH SPEED STEEL-TIN COATED



Size	Thread			Pitch Diameter Limits	Number of Flutes	E.D.P.						Dimensions			Std. Pack.
	UNC	UNF	UNS			Taper		Plug		Bottom		Overall Length	Thread Length	Shank Dia.	
						L911	L911P	L911	L911P	L911	L911P				
1/4	20			H2	4	64059		64060		64061		2 1/2	1	0.255	3
1/4	20			H3	4	64068	24068	64069	24069	64070	24070	2 1/2	1	0.255	3
1/4	20			H5	4			64075		64076		2 1/2	1	0.255	3
1/4		28		H3	4	64089	24089	64090	24090	64091	24091	2 1/2	1	0.255	3
1/4		28		H4	4			64093		64094		2 1/2	1	0.255	3
5/16	18			H2	4	64098		64099		64100		2 23/32	1 1/8	0.318	3
5/16	18			H3	4	64107	24107	64108	24108	64109	24109	2 23/32	1 1/8	0.318	3
5/16	18			H5	4			64111		64112		2 23/32	1 1/8	0.318	3
5/16		24		H3	4	64122	24122	64123	24123	64124	24124	2 23/32	1 1/8	0.318	3
5/16		24		H4	4			64126		64127		2 23/32	1 1/8	0.318	3
3/8	16			H2	4	64131		64132		64133		2 15/16	1 1/4	0.381	3
3/8	16			H3	4	64137	24137	64138	24138	64139	24139	2 15/16	1 1/4	0.381	3
3/8	16			H5	4			64141		64142		2 15/16	1 1/4	0.381	3
3/8		24		H3	4	64152	24152	64153	24153	64154	24154	2 15/16	1 1/4	0.381	3
3/8		24		H4	4			64156		64157		2 15/16	1 1/4	0.381	3
7/16	14			H3	4	64167	24167	64168	24168	64169	24169	3 5/32	1 7/16	0.323	3
7/16		20		H3	4	64182	24182	64183	24183	64184	24184	3 5/32	1 7/16	0.323	3
1/2	13			H3	4	64197	24197	64198	24198	64199	24199	3 3/8	1 21/32	0.367	3
1/2	13			H5	4			64201		64202		3 3/8	1 21/32	0.367	3
1/2		20		H3	4	64212	24212	64213	24213	64214	24214	3 3/8	1 21/32	0.367	3
1/2		20		H5	4			64216		64217		3 3/8	1 21/32	0.367	3
9/16	12			H3	4	64221	24221	64222	24222	64223	24223	3 19/32	1 21/32	0.429	3
9/16		18		H3	4	64230	24230	64231	24231	64232	24232	3 19/32	1 21/32	0.429	3
5/8	11			H3	4	64242	24242	64243	24243	64244	24244	3 13/16	1 13/16	0.480	3
5/8	11			H5	4			64246		64247		3 13/16	1 13/16	0.480	3
5/8		18		H3	4	64254	24254	64255	24255	64256	24256	3 13/16	1 13/16	0.480	3
5/8		18		H5	4			64258		64259		3 13/16	1 13/16	0.480	3
11/16			11	H3	4	64260		64261		64262		4 1/32	1 13/16	0.542	3
11/16			16	H3	4	64263		64264		64265		4 1/32	1 13/16	0.542	3
3/4	10			H3	4	64272	24272	64273	24273	64274	24274	4 1/4	2	0.590	3
3/4	10			H5	4			64276		64277		4 1/4	2	0.590	3
3/4		16		H3	4	64284	24284	64285	24285	64286	24286	4 1/4	2	0.590	3
3/4		16		H5	4			64288		64289		4 1/4	2	0.590	3
7/8	9			H4	4	64293	24293	64294	24294	64295	24295	4 11/16	2 7/32	0.697	3
7/8		14		H4	4	64302	24302	64303	24303	64304	24304	4 11/16	2 7/32	0.697	3
1		8		H4	4	64311	24311	64312	24312	64313	24313	5 1/8	2 1/2	0.800	3
1		12		H4	4	64314		64315		64316		5 1/8	2 1/2	0.800	3
1			14	H4	4	64320		64321		64322		5 1/8	2 1/2	0.800	3
1 1/8	7			H4	4	64323		64324		64325		5 7/16	2 9/16	0.896	1
1 1/8		12		H4	4	64326		64327		64328		5 7/16	2 9/16	0.896	1
1 1/4	7			H4	4	64329		64330		64331		5 3/4	2 9/16	1.021	1
1 1/4		12		H4	6	64332		64333		64334		5 3/4	2 9/16	1.021	1
1 3/8	6			H4	4	64335		64336		64337		6 1/16	3	1.108	1
1 3/8		12		H4	6	64338		64339		64340		6 1/16	3	1.108	1
1 1/2	6			H4	4	64341		64342		64343		6 3/8	3	1.233	1
1 1/2		12		H4	6	64344		64345		64346		6 3/8	3	1.233	1

Order by EDP Number

List No.913 Machine Screw Size

HIGH SPEED STEEL



Bright Finish



List No.913P Machine Screw Sizes

HIGH SPEED STEEL-TIN COATED



Titanium Nitride



Nominal Tap Size	Threads		Pitch Diameter Limits	Number of Flutes	E.D.P. Numbers						Dimensions			Std. Pack.
	NC UNC	NF UNF			Taper		Plug		Bottom		Overall Length	Thread Length	Shank Dia.	
					L913	L913P	L913	L913P	L913	L913P				
0		80	H1	2	64360		64361		64362		1 5/8	5/16	0.141	3
0		80	H2	2			64364	24364	64365	24365	1 5/8	5/16	0.141	3
1	64		H1	2	64366		64367		64368		1 11/16	3/8	0.141	3
1	64		H2	2			64370				1 11/16	3/8	0.141	3
1		72	H1	2	64372		64373		64374		1 11/16	3/8	0.141	3
1		72	H2	2			64376		64377		1 11/16	3/8	0.141	3
2	56		H1	3	64381		64382		64383		1 3/4	7/16	0.141	3
2	56		H2	3	64387	24387	64388	24388	64389	24389	1 3/4	7/16	0.141	3
2		64	H1	3	64390		64391		64392		1 3/4	7/16	0.141	3
2		64	H2	3	64393		64394		64395		1 3/4	7/16	0.141	3
3	48		H1	3			64397				1 13/16	1/2	0.141	3
3	48		H2	3	64402		64403		64404		1 13/16	1/2	0.141	3
3		56	H1	3			64406				1 13/16	1/2	0.141	3
3		56	H2	3	64408		64409		64410		1 13/16	1/2	0.141	3
4	36NS		H2	3	64411		64412		64413		1 7/8	9/16	0.141	3
4	40		H1	3	64417		64418		64419		1 7/8	9/16	0.141	3
4	40		H2	3	64423	24423	64424	24424	64425	24425	1 7/8	9/16	0.141	3
4		48	H1	3			64427				1 7/8	9/16	0.141	3
4		48	H2	3	64429		64430		64431		1 7/8	9/16	0.141	3
5	40		H1	3			64433		64434		1 15/16	5/8	0.141	3
5	40		H2	3	64438	24438	64439	24439	64440	24440	1 15/16	5/8	0.141	3
5		44	H1	3			64442		64443		1 15/16	5/8	0.141	3
5		44	H2	3	64447		64448		64449		1 15/16	5/8	0.141	3
6	32		H2	3	64459		64460		64461		2	11/16	0.141	3
6	32		H3	3	64465	24465	64466	24466	64467	24467	2	11/16	0.141	3
6	32		H7	3			64469		64470		2	11/16	0.141	3
6		40	H1	3			64472				2	11/16	0.141	3
6		40	H2	3	64477		64478		64479		2	11/16	0.141	3
8	32		H2	4	64495		64496		64497		2 1/8	3/4	0.168	3
8	32		H3	4	64504	24504	64505	24505	64506	24506	2 1/8	3/4	0.168	3
8	32		H7	4			64508		64509		2 1/8	3/4	0.168	3
8		36	H1	4			64515				2 1/8	3/4	0.168	3
8		36	H2	4	64517		64518		64519		2 1/8	3/4	0.168	3
10	24		H2	4	64532		64533		64534		2 3/8	7/8	0.194	3
10	24		H3	4	64541	24541	64542	24542	64543	24543	2 3/8	7/8	0.194	3
10	24		H7	4			64548		64549		2 3/8	7/8	0.194	3
10		32	H2	4	64562		64563		64564		2 3/8	7/8	0.194	3
10		32	H3	4	64571	24571	64572	24572	64573	24573	2 3/8	7/8	0.194	3
10		32	H7	4			64578		64579		2 3/8	7/8	0.194	3
12	24		H3	4	64583	24583	64584	24584	64585	24585	2 3/8	15/16	0.220	3
12		28	H3	4	64589		64590		64591		2 3/8	15/16	0.220	3

Order by EDP Number

Technical Data

DRILLS

DRILLS
Cutting Condition

END MILLS

END MILLS
Cutting Condition

TAPS

TAPS
Cutting Condition

Others

STANDARD TAPS SPIRAL POINTED / FRACTIONAL SIZES STANDARD HAND TAPS / FOR CAST IRON

Technical Data

DRILLS

DRILLS
Cutting Condition

END MILLS

END MILLS
Cutting Condition

TAPS

TAPS
Cutting Condition

Others

List No.921 Fractional Sizes



Plug Style
Bright Finish

HIGH SPEED STEEL



List No.921P Fractional Sizes



Plug Style
Titanium Nitride Coated

HIGH SPEED STEEL-TIN COATED



List No.921S Fractional Sizes



Plug Style
Surface Treated

HIGH SPEED STEEL



Nominal Tap Size	Threads per inch		Pitch Diameter Limits	Number of Flutes	E.D.P. Numbers			Dimensions			Std. Pack.
	NC UNC	NF UNF			Plug			Overall Length	Thread Length	Shank Dia.	
					L921	L921S	L921P				
1/4	20		H3	2	67054	67402	27054	2 1/2	1	0.255	3
1/4	20		H3	3	67056			2 1/2	1	0.255	3
1/4		28	H3	2	67068	67409	27068	2 1/2	1	0.255	3
5/16	18		H3	2	67078	67414	27078	2 23/32	1 1/8	0.318	3
5/16	18		H3	3	67080		27080	2 23/32	1 1/8	0.318	3
5/16		24	H3	2	67092	67421	27092	2 23/32	1 1/8	0.318	3
3/8	16		H2	3	67100			2 15/16	1 1/4	0.381	3
3/8	16		H3	3	67102	67426	27102	2 15/16	1 1/4	0.381	3
3/8	16		H5	3	67104		27106	2 15/16	1 1/4	0.381	3
3/8		24	H3	3	67110	67430	27110	2 15/16	1 1/4	0.381	3
7/16	14		H3	3	67116	67433	27116	3 5/32	1 7/16	0.323	3
7/16		20	H3	3	67122	67436	27122	3 5/32	1 7/16	0.323	3
1/2	13		H3	3	67130	67440	27130	3 3/8	1 21/32	0.367	3
1/2		20	H3	3	67138	67444	27138	3 3/8	1 21/32	0.367	3
9/16	12		H3	3	67142		27142	3 19/32	1 21/32	0.429	3
5/8	11		H3	3	67148	67447	27148	3 13/16	1 13/16	0.480	3
3/4	10		H3	3	67150	67450	27150	4 1/4	2	0.590	3

Order by EDP Number

List No.969 For Cast Iron

HIGH SPEED STEEL



Surface Treated



Size	Threads		Thread Limits	Number of Flutes	E.D.P.		Dimensions			Std. Pack.
	UNC	UNF			Plug	Bottom	Overall Length	Thread Length	Shank Dia.	
1/4	20		H3	4	76001	76002	2 1/2	1	0.255	12
	20		H5	4	76003	76004	2 1/2	1	0.255	12
5/16		28	H3	4	76005	76006	2 1/2	1	0.255	12
	18		H3	4	76007	76008	2 23/32	1 1/8	0.318	12
3/8	18		H5	4	76009	76010	2 23/32	1 1/8	0.318	12
		24	H3	4	76011	76012	2 23/32	1 1/8	0.318	12
7/16	16		H3	4	76013	76014	2 15/16	1 1/4	0.381	12
	16		H5	4	76015	76016	2 15/16	1 1/4	0.381	12
1/2		24	H3	4	76017	76018	2 15/16	1 1/4	0.381	12
	14		H3	4	76019	76020	3 5/32	1 7/16	0.323	12
9/16	14		H5	4	76021	76022	3 5/32	1 7/16	0.323	12
		20	H3	4	76023	76024	3 5/32	1 7/16	0.323	12
5/8		20	H5	4	76025	76026	3 5/32	1 7/16	0.323	12
	13		H3	4	76027	76028	3 3/8	1 21/32	0.367	12
3/4	13		H5	4	76029	76030	3 3/8	1 21/32	0.367	12
		20	H3	4	76031	76032	3 3/8	1 21/32	0.367	12
Others		20	H5	4	76033	76034	3 3/8	1 21/32	0.367	12
	12		H3	4	76035	76036	3 19/32	1 21/32	0.429	6
Others		18	H3	4	76037	76038	3 19/32	1 21/32	0.429	6
	11		H3	4	76039	76040	3 13/16	1 13/16	0.480	6
Others		18	H3	4	76041	76042	3 13/16	1 13/16	0.480	6
	10		H3	4	76043	76044	4 1/4	2	0.590	6
Others		16	H3	4	76045	76046	4 1/4	2	0.590	6

List No.923 Machine Screw Sizes



Plug Style
Bright Finish

HIGH SPEED STEEL



List No.923P Machine Screw Sizes



Plug Style
Titanium Nitride Coated

HIGH SPEED STEEL-TIN COATED



List No.923S Machine Screw Sizes



Plug Style
Surface Treated

HIGH SPEED STEEL



Nominal Tap Size	Threads per inch		Pitch Diameter Limits	Number of Flutes	E.D.P. Numbers			Dimensions			Std. Pack.
	NC UNC	NF UNF			Plug			Overall Length	Thread Length	Shank Dia.	
					L923	L923S	L923P				
0		80	H1	2	67200			1 5/8	5/16	0.141	3
0		80	H2	2	67202		27202	1 5/8	5/16	0.141	3
1	64		H1	2	67206			1 11/16	3/8	0.141	3
1	64		H2	2	67208			1 11/16	3/8	0.141	3
1		72	H1	2	67210			1 11/16	3/8	0.141	3
1		72	H2	2	67212			1 11/16	3/8	0.141	3
2	56		H1	2	67214			1 3/4	7/16	0.141	3
2	56		H2	2	67216		27216	1 3/4	7/16	0.141	3
2		64	H2	2	67224			1 3/4	7/16	0.141	3
3	48		H2	2	67228	67514		1 13/16	1/2	0.141	3
3		56	H2	2	67234	67517		1 13/16	1/2	0.141	3
4	36NS		H2	2	67236			1 7/8	9/16	0.141	3
4	40		H1	2	67238			1 7/8	9/16	0.141	3
4	40		H2	2	67240	67520	27240	1 7/8	9/16	0.141	3
4		48	H2	2	67248	67524		1 7/8	9/16	0.141	3
5	40		H1	2	67250			1 15/16	5/8	0.141	3
5	40		H2	2	67252	67526	27252	1 15/16	5/8	0.141	3
5		44	H2	2	67254	67527		1 15/16	5/8	0.141	3
6	32		H2	2	67258		27258	2	11/16	0.141	3
6	32		H3	2	67260	67530	27260	2	11/16	0.141	3
6	32		H7	2	67264			2	11/16	0.141	3
6		40	H2	2	67268	67534		2	11/16	0.141	3
8	32		H2	2	67272		27272	2 1/8	3/4	0.168	3
8	32		H3	2	67274	67537	27274	2 1/8	3/4	0.168	3
8	32		H7	2	67278			2 1/8	3/4	0.168	3
8		36	H2	2	67282	67541		2 1/8	3/4	0.168	3
10	24		H2	2	67286		27286	2 3/8	7/8	0.194	3
10	24		H3	2	67288	67544	27288	2 3/8	7/8	0.194	3
10	24		H7	2	67290			2 3/8	7/8	0.194	3
10		32	H2	2	67294		27294	2 3/8	7/8	0.194	3
10		32	H3	2	67296	67548	27296	2 3/8	7/8	0.194	3
10		32	H7	2	67300			2 3/8	7/8	0.194	3
12	24		H3	2	67304	67552	27304	2 3/8	15/16	0.220	3

Order by EDP Number

Technical Data

DRILLS

DRILLS
Cutting Condition

END MILLS

END MILLS
Cutting Condition

TAPS

TAPS
Cutting Condition

Others

STANDARD TAPS / SPIRAL FLUTED

Technical Data

DRILLS

DRILLS
Cutting Condition

END MILLS

END MILLS
Cutting Condition

TAPS

TAPS
Cutting Condition

Others

* **List No.931** Fractional Sizes

HIGH SPEED STEEL



Spiral Fluted
Bright Finish



Nominal Tap Size	Threads Per Inch		Pitch Dia. Limit	Number of Flutes	E.D.P. Bottom	Dimensions			Std. Pack.
	UNC	UNF				Overall Length	Thread Length	Shank Dia.	
1/4	20		H3	2	68055	2 1/2	1	0.255	3
1/4	20		H3	3	68057	2 1/2	1	0.255	3
1/4		28	H3	2	68069	2 1/2	1	0.255	3
1/4		28	H3	3	68071	2 1/2	1	0.255	3
5/16	18		H3	2	68079	2 23/32	1 1/8	0.318	3
5/16	18		H3	3	68081	2 23/32	1 1/8	0.318	3
5/16		24	H3	2	68093	2 23/32	1 1/8	0.318	3
5/16		24	H3	3	68095	2 23/32	1 1/8	0.318	3
3/8	16		H3	3	68103	2 15/16	1 1/4	0.381	3
3/8		24	H3	3	68111	2 15/16	1 1/4	0.381	3
7/16	14		H3	3	68117	3 5/32	1 7/16	0.323	3
7/16		20	H3	3	68123	3 5/32	1 7/16	0.323	3
1/2	13		H3	3	68131	3 3/8	1 21/32	0.367	3
1/2		20	H3	3	68139	3 3/8	1 21/32	0.367	3

Order by EDP Number

* **List No.933** Machine Screw Sizes

HIGH SPEED STEEL



Spiral Fluted
Bright Finish



Nominal Tap Size	Threads Per Inch		Pitch Dia. Limit	Number of Flutes	E.D.P. Bottom	Dimensions			Std. Pack.
	UNC	UNF				Overall Length	Thread Length	Shank Dia.	
3	48		H2	2	68229	1 13/16	1/2	0.141	3
3		56	H2	2	68235	1 13/16	1/2	0.141	3
4	40		H2	2	68241	1 7/8	9/16	0.141	3
4		48	H2	2	68249	1 7/8	9/16	0.141	3
5	40		H2	2	68253	1 15/16	5/8	0.141	3
5		44	H2	2	68255	1 15/16	5/8	0.141	3
6	32		H3	2	68261	2	11/16	0.141	3
6		40	H2	2	68269	2	11/16	0.141	3
8	32		H3	2	68275	2 1/8	3/4	0.168	3
8		36	H2	2	68283	2 1/8	3/4	0.168	3
10	24		H3	2	68289	2 3/8	7/8	0.194	3
10		32	H3	2	68297	2 3/8	7/8	0.194	3
12	24		H3	2	68305	2 3/8	15/16	0.220	3
12		28	H3	2	68307	2 3/8	15/16	0.220	3

Order by EDP Number

* item will be discontinued, after stock has depleted.

* **List No.931H** Fractional Sizes

HIGH SPEED STEEL



High Helix Taps
Fast Spiral Flute
Bright Finish



Nominal Tap Size	Threads Per Inch		Pitch Dia. Limit	Number of Flutes	E.D.P. Bottom	Dimensions			Std. Pack.
	UNC	UNF				Overall Length	Thread Length	Shank Dia.	
1/4	20		H3	3	68357	2 1/2	1	0.255	3
1/4		28	H3	3	68371	2 1/2	1	0.255	3
5/16	18		H3	3	68381	2 23/32	1 1/8	0.318	3
5/16		24	H3	3	68395	2 23/32	1 1/8	0.318	3
3/8	16		H3	3	68403	2 15/16	1 1/4	0.381	3
3/8		24	H3	3	68411	2 15/16	1 1/4	0.381	3
7/16	14		H3	3	68417	3 5/32	1 7/16	0.323	3
7/16		20	H3	3	68423	3 5/32	1 7/16	0.323	3
1/2	13		H3	3	68431	3 3/8	1 21/32	0.367	3
1/2		20	H3	3	68439	3 3/8	1 21/32	0.367	3

Order by EDP Number

* **List No.933H** Machine Screw Sizes

HIGH SPEED STEEL



High Helix Taps
Fast Spiral Flute
Bright Finish



Nominal Tap Size	Threads Per Inch		Pitch Dia. Limit	Number of Flutes	E.D.P. Bottom	Dimensions			Std. Pack.
	UNC	UNF				Overall Length	Thread Length	Shank Dia.	
3	48		H2	2	68529	1 13/16	1/2	0.141	3
4	40		H2	2	68541	1 7/8	9/16	0.141	3
5	40		H2	2	68553	1 15/16	5/8	0.141	3
6	32		H3	2	68561	2	11/16	0.141	3
8	32		H3	3	68573	2 1/8	3/4	0.168	3
10	24		H3	3	68587	2 3/8	7/8	0.194	3
10		32	H3	3	68595	2 3/8	7/8	0.194	3

Order by EDP Number

* item will be discontinued, after stock has depleted.

Technical Data

DRILLS

DRILLS
Cutting Condition

END MILLS

END MILLS
Cutting Condition

TAPS

TAPS
Cutting Condition

Others

Technical Data

DRILLS

DRILLS
Cutting Condition

END MILLS

END MILLS
Cutting Condition

TAPS

TAPS
Cutting Condition

Others

* **List No.915** Fractional Sizes & Machine Screw Sizes **HIGH SPEED STEEL**



Hand Taps
Plug Style
.005 Oversized
Bright Finish



Nominal Tap Size	Threads		Pitch Limits	Number of Flutes	E.D.P. Number	Dimensions			Std. Pack.
	UNC	UNF				Overall Length	Thread Length	Shank Dia.	
6	32		H13	3	64612	2	11/16	0.141	3
8	32		H13	4	64614	2 1/8	3/4	0.168	3
10	24		H13	4	64616	2 3/8	7/8	0.194	3
10		32	H13	4	64617	2 3/8	7/8	0.194	3
1/4	20		H13	4	64621	2 1/2	1	0.255	3
1/4		28	H13	4	64622	2 1/2	1	0.255	3
5/16	18		H13	4	64623	2 23/32	1 1/8	0.318	3
5/16		24	H13	4	64624	2 23/32	1 1/8	0.318	3
3/8	16		H13	4	64625	2 15/16	1 1/4	0.381	3
3/8		24	H13	4	64626	2 15/16	1 1/4	0.381	3
7/16	14		H13	4	64627	3 5/32	1 7/16	0.323	3
7/16		20	H13	4	64628	3 5/32	1 7/16	0.323	3
1/2	13		H13	4	64629	3 3/8	1 21/32	0.367	3
1/2		20	H13	4	64630	3 3/8	1 21/32	0.367	3
9/16	12		H13	4	64631	3 19/32	1 21/32	0.429	3
5/8	11		H13	4	64633	3 13/16	1 13/16	0.480	3
3/4	10		H13	4	64637	4 1/4	2	0.590	3
7/8	9		H13	4	64639	4 11/16	2 7/32	0.697	3
1	8		H13	4	64641	5 1/8	2 1/2	0.800	3

Order by EDP Number * item will be discontinued, after stock has depleted.

List No.925 Fractional & Machine Screw Sizes **HIGH SPEED STEEL**



Spiral Pointed
Plug Style
.005 Oversized
Bright Finish



Nominal Tap Size	Threads		Pitch Dia. Limits	Number of Flutes	E.D.P. Number	Dimensions			Std. Pack.
	UNC	UNF				Overall Length	Thread Length	Shank Dia.	
6	32		H13	2	67612	2	11/16	0.141	3
8	32		H13	2	67614	2 1/8	3/4	0.168	3
10	24		H13	2	67616	2 3/8	7/8	0.194	3
10		32	H13	2	67617	2 3/8	7/8	0.194	3
1/4	20		H13	2	67621	2 1/2	1	0.255	3
1/4		28	H13	2	67622	2 1/2	1	0.255	3
5/16	18		H13	2	67623	2 23/32	1 1/8	0.318	3
5/16		24	H13	2	67624	2 23/32	1 1/8	0.318	3
3/8	16		H13	3	67625	2 15/16	1 1/4	0.381	3
3/8		24	H13	3	67626	2 15/16	1 1/4	0.381	3
7/16	14		H13	3	67627	3 5/32	1 7/16	0.323	3
7/16		20	H13	3	67628	3 5/32	1 7/16	0.323	3
1/2	13		H13	3	67629	3 3/8	1 21/32	0.367	3
1/2		20	H13	3	67630	3 3/8	1 21/32	0.367	3
9/16	12		H13	3	67631	3 19/32	1 21/32	0.429	3
5/8	11		H13	3	67633	3 13/16	1 13/16	0.480	3
3/4	10		H13	3	67637	4 1/4	2	0.590	3

**TAPER PIPE TAPS / STRAIGHT FLUTED
TAPER PIPE TAPS / INTERRUPTED**

List No.941 (NPT)



Taper Pipe Taps
Bright Finish

HIGH SPEED STEEL



List No.941P (NPT)



Taper Pipe Taps
Titanium Nitride

HIGH SPEED STEEL-TIN COATED



List No.941D (NPTF)



Dry Seal Taper Pipe Taps
Bright Finish

HIGH SPEED STEEL



Nominal Tap Size	Threads per Inch	Number of Flutes	E.D.P. Number			Dimensions					Std. Pack
			L941	L941D	L941P	Overall Length	Thread Length	Shank Dia.	Square Length	Size of Square	
1/16	27	4	74051	74062	34062	2.1260	0.6890	0.3125	0.3740	0.2339	1
1/8	27	4	74052	74063	34063	2.1260	0.7520	0.4375	0.3740	0.3280	1
1/8SS	27	4	74053	74064	34064	2.1260	0.7520	0.3125	0.3740	0.2339	1
1/4	18	4	74054	74065	34065	2.4370	1.0630	0.5625	0.4370	0.4209	1
3/8	18	4	74055	74066	34066	2.5630	1.0630	0.7	0.5	0.5307	1
1/2	14	4	74056	74067	34067	3.1260	1.3740	0.6875	0.626	0.5150	1
3/4	14	5	74057	74068	34068	3.2520	1.3740	0.9063	0.689	0.6787	1
1	11 1/2	5	74058	74069	34069	3.7520	1.7520	1.125	0.811	0.8429	1
1 1/4	11 1/2	5	74059	74070		4	1.7520	1.3125	0.9370	0.9839	1
1 1/2	11 1/2	7	74060	74071		4.2520	1.7520	1.5	1	1.1248	1
2	11 1/2	7	74061	74072		4.5	1.7520	1.875	1.126	1.4059	1

List No.943 (NPT)



Interrupted Pipe Taps
Bright Finish

HIGH SPEED STEEL



Nominal Tap Size	Threads per Inch	Number of Flutes	E.D.P. Number	Dimensions					Std. Pack
				Overall Length	Thread Length	Shank Dia.	Square Length	Size of Square	
1/8	27	5	74073	2.126	0.752	0.4375	0.3740	0.3280	1
1/4	18	5	74075	2.437	1.063	0.5625	0.4370	0.4209	1
3/8	18	5	74076	2.563	1.063	0.7	0.5	0.5307	1
1/2	14	5	74077	3.126	1.374	0.6875	0.626	0.5150	1
3/4	14	5	74078	3.252	1.374	0.9063	0.689	0.6787	1
1	11 1/2	5	74079	3.752	1.752	1.125	0.811	0.8429	1
1 1/4	11 1/2	5	74080	4	1.752	1.3125	0.9370	0.9839	1
1 1/2	11 1/2	7	74081	4.252	1.752	1.5	1	1.1248	1
2	11 1/2	7	74082	4.5	1.752	1.875	1.126	1.4059	1

Technical Data

DRILLS

DRILLS
Cutting Condition

END MILLS

END MILLS
Cutting Condition

TAPS

TAPS
Cutting Condition

Others

**TAPER PIPE TAPS / SPIRAL FLUTED
STRAIGHT PIPE TAPS / STRAIGHT FLUTED**

Technical Data

List No.947 (NPT)



Taper Pipe-Spiral Fluted
Surface Treated

PREMIUM TYPE STEEL



List No.947D (NPTF)



Dry Seal Taper Pipe-Spiral Fluted
Surface Treated

PREMIUM TYPE STEEL



DRILLS

DRILLS
Cutting Condition

Nominal Tap Size	Thread Per Inch	Number of Flutes	E.D.P. Numbers		Dimensions					Std. Pack.
			L947	L947D	Overall Length	Thread Length	Shank Dia.	Square Length	Size of Square	
1/16	27	4	84051	84062	2.126	0.689	0.3125	0.374	0.2339	1
1/8	27	4	84052	84063	2.126	0.752	0.4375	0.374	0.3280	1
1/8SS	27	4	84053	84064	2.126	0.752	0.3125	0.374	0.2339	1
1/4	18	4	84054	84065	2.437	1.063	0.5625	0.437	0.4209	1
3/8	18	4	84055	84066	2.563	1.063	0.7	0.5	0.5307	1
1/2	14	4	84056	84067	3.126	1.374	0.6875	0.626	0.5150	1
3/4	14	5	84057	84068	3.252	1.374	0.9063	0.689	0.6787	1
1	11 1/2	5	84058	84069	3.752	1.752	1.125	0.811	0.8429	1

END MILLS

END MILLS
Cutting Condition

List No.945 (NPS)



Straight Pipe Taps
Bright Finish

HIGH SPEED STEEL



List No.945D (NPSF)



Dry Seal Straight Pipe Taps
Bright Finish

HIGH SPEED STEEL



TAPS

TAPS
Cutting Condition

Nominal Tap Size	Thread Per Inch	Number of Flutes	E.D.P. Numbers		Dimensions					Std. Pack.
			L945	L945D	Overall Length	Thread Length	Shank Dia.	Square Length	Size of Square	
1/8	27	4	74083	74090	2.126	0.752	0.4375	0.3740	0.3280	1
1/8SS	27	4	74084	74091	2.126	0.752	0.3125	0.3740	0.2339	1
1/4	18	4	74085	74092	2.437	1.063	0.5625	0.4370	0.4209	1
3/8	18	4	74086	74093	2.563	1.063	0.7	0.5	0.5307	1
1/2	14	4	74087	74094	3.126	1.374	0.6875	0.626	0.5150	1
3/4	14	5	74088	74095	3.252	1.374	0.9063	0.689	0.6787	1
1	11 1/2	5	74089		3.752	1.752	1.125	0.811	0.8429	1

Order by EDP Number

Others

STANDARD METRIC HAND TAPS
STANDARD METRIC TAPS / SPIRAL POINTED

List No.910



HIGH SPEED STEEL



Nominal Tap Size (mm)	Millimeter Pitch (mm)	Pitch Dia. Limits	Number of Flutes	E.D.P. Numbers			Dimensions			Std. Pack.
				Taper	Plug	Bottom	Overall Length	Thread Length	Shank Dia.	
M2	0.4	D3	3	54056	54057	54058	1 3/4	7/16	0.141	3
M3	0.5	D3	3	54071	54072	54073	1 15/16	5/8	0.141	3
M3.5	0.6	D4	3	54074	54075	54076	2	11/16	0.141	3
M4	0.7	D4	4	54080	54081	54082	2 1/8	3/4	0.168	3
M5	0.8	D4	4	54095	54096	54097	2 3/8	7/8	0.194	3
M6	1.0	D5	4	54107	54108	54109	2 1/2	1	0.255	3
M7	1.0	D5	4	54113	54114	54115	2 23/32	1 1/8	0.318	3
M8	1.25	D5	4	54125	54126	54127	2 23/32	1 1/8	0.318	3
M10	1.5	D6	4	54140	54141	54142	2 15/16	1 1/4	0.381	3
M12	1.75	D6	4	54155	54156	54157	3 3/8	1 21/32	0.367	3
M14	1.25	D5	4	54161	54162	54163	3 19/32	1 21/32	0.429	3
M14	2.0	D7	4	54167	54168	54169	3 19/32	1 21/32	0.429	3
M16	2.0	D7	4	54176	54177	54178	3 13/16	1 13/16	0.480	3
M18	1.5	D7	4	54182	54183	54184	4 1/32	1 13/16	0.542	3
M18	2.5	D7	4	54188	54189	54190	4 1/32	1 13/16	0.542	3
M20	2.5	D7	4	54200	54201	54202	4 15/32	2	0.652	3
M22	2.5	D7	4	54212	54213	54214	4 11/16	2 7/32	0.697	3
M24	3.0	D8	4	54224	54225	54226	4 29/32	2 7/32	0.760	3
M27	3.0	D8	4	54239	54240	54241	5 1/8	2 1/2	0.896	3
M30	3.5	D9	4	54251	54252	54253	5 7/16	2 9/16	1.021	3

Order by EDP Number

List No.920



HIGH SPEED STEEL



Nominal Tap Size (mm)	Pitch (mm)	Pitch Diameter Limits	Number of Flutes	E.D.P. Numbers	Dimensions			Std. Pack.
					Overall Length	Thread Length	Shank Dia.	
M2.5	0.45	D3	2	57054	1 13/16	1/2	0.141	3
M3	0.50	D3	2	57055	1 15/16	5/8	0.141	3
M4	0.70	D4	2	57058	2 1/8	3/4	0.168	3
M5	0.80	D4	2	57061	2 3/8	7/8	0.194	3
M6	1.00	D5	2	57063	2 1/2	1	0.255	3
M8	1.25	D5	2	57068	2 23/32	1 1/8	0.318	3
M10	1.50	D6	3	57082	2 15/16	1 1/4	0.381	3
M12	1.75	D6	3	57073	3 3/8	1 21/32	0.367	3
M14	2.00	D7	3	57076	3 19/32	1 21/32	0.429	3
M16	2.00	D7	3	57078	3 13/16	1 13/16	0.480	3

Order by EDP Number

Technical Data

DRILLS

DRILLS Cutting Condition

END MILLS

END MILLS Cutting Condition

TAPS

TAPS Cutting Condition

Others

Technical Data

DRILLS

DRILLS Cutting Condition

END MILLS

END MILLS Cutting Condition

TAPS

TAPS Cutting Condition

Others

SG-Low Spiral Taps List No. 6958, 6959
SFM : Surface Feet per Minutes

Work Materials		Tapping Speed SFM
Low Carbon Steel	1010,1018	25-50
Medium Carbon Steel	1035,1045	20-50
High Carbon Steel	1065,1095	15-30
Alloy Steel	4140,4130	15-30
Die Steels	D2,H13	15-35
Hardened Die Steels(20-40HRC)	D2,H13	8-15
Stainless steel (Austenitic)	303,304,316	15-45
Stainless steel (Martensitic)	410,430	12-20
Stainless steel (PH) up to 35HRC	17-4PH	12-20
Titanium Alloy Up to 32HRC	6AL4V	15-20
Magnesium Alloy		40-80
Ductile cast Irons	80-55-06	20-50
Cast Irons	Nodular,Grey	30-65

1. These are general tapping condition, may be altered by your condition.
2. These conditions are for tapping depth 1.5D. In case of deeper thread you may multiply these values by the coefficient of next table.

Thread depth	Coefficient
Up to 1.5D	1
1.5D~2.5D	0.9
2.5D~3D	0.8
Over 3D	0.7

VIPER T Series

SFM:Surface Feet per Minutes
 Viper T SPIRAL Flute TAP List 7981,7980,7987,7982

Work Materials		Tapping Speed SFM
Low Carbon Steel	1010,1018	30-60
Medium Carbon Steel	1035,1045	15-40
High Carbon Steel	1065,1095	15-25
Alloy Steel	4140,4130	15-40
Die Steels	D2,H13	10-25
Hardened Die Steels(20-40HRC)	D2,H13	6-12
Stainless steel (Austenitic)	303,304,316	10-25
Stainless steel (Martensitic)	410,430	10-25
Stainless steel (PH) up to 35HRC	17-4PH	8-15
Titanium Alloy Up to 32HRC	6AL4V	10-15
Magnesium Alloy		30-60
Ductile cast Irons	80-55-06	15-40
Cast Irons	Nodular,Grey	-
Copper		15-40
Brass,Brass casting		40-60
Bronze,Bronze casting		25-50

1. These are general tapping condition, may be altered by your condition.
2. These conditions are for tapping depth 1.5D. In case of deeper thread you may multiply these values by the coefficient of next table

Thread depth	Coefficient
Up to 1.5D	1
1.5D ~ 2.5D	0.9
2.5D ~ 3D	0.8
Over 3D	0.7

SFM:Surface Feet per Minutes

Viper T SPIRAL POINTED TAP List 7971,7970,7977,7972

Work Materials		Tapping Speed SFM
Low Carbon Steel	1010,1018	35-75
Medium Carbon Steel	1035,1045	20-50
High Carbon Steel	1065,1095	15-30
Alloy Steel	4140,4130	20-50
Die Steels	D2,H13	15-30
Hardened Die Steels(20-40HRC)	D2,H13	8-15
Stainless steel (Austenitic)	303,304,316	15-35
Stainless steel (Martensitic)	410,430	15-35
Stainless steel (PH) up to 35HRC	17-4PH	10-20
Titanium Alloy Up to 32HRC	6AL4V	15-20
Magnesium Alloy		40-80
Ductile cast Irons	80-55-06	20-50
Cast Irons	Nodular,Grey	30-60
Copper		20-50
Brass,Brass casting		50-80
Bronze,Bronze casting		30-60

1. These are general tapping condition, may be altered by your condition.
2. These conditions are for tapping depth 1.5D. In case of deeper thread you may multiply these values by the coefficient of next table

Thread depth	Coefficient
Up to 1.5D	1
1.5D ~ 2.5D	0.9
2.5D ~ 3D	0.8
Over 3D	0.7

DLC TAFLET THREAD FORMING TAPS List No. 6955, 6956, 6957

Work Materials	Tapping Speed SFM
Aluminium Alloys	70 - 130

Other TAPS

Material	Tapping Speed SFM
Aluminum Alloys	90-100
Brass	60-100
Bronze	40-60
Copper	40-60
High Temperature Alloys,	
Cobalt Base	5-10
Iron Base	10-15
Nickel Base	5-10
Iron, Ductile,	
Annealed	60
as Cast	30
Tempered	15-20
Gray,	
Annealed	80
as Cast	35-60
Malleable	60
Heat Treated	25-50
Magnesium Alloys	175
Manganese	20
Molybdenum Alloys	50
Monel	20
Nickel Alloys	25
Plastics, Reinforced	25
Thermoplastics	50
Thermosetting Plastics	50
Steels, Alloys, Annealed or Cold Drawn	40-60
Quenched & Tempered	15-35
Armor Plate	10

Material	Tapping Speed SFM
(Steels, Cont.)	
Carbon Steel, Plain,	
Annealed	40-80
Tempered	15-40
Cast, Carbon	
Annealed	40-50
Tempered	30
Cast, Corrosion Resistant,	
Annealed	20-30
as Cast	20-25
Heat Resistant,	
Low Alloy	30-45
Tempered	15-25
Precipitation Hardening,	
Treated	10-15
Stainless	
Annealed	15-45
Tempered	15-75
Free Machining,	
Annealed	45-75
Tool Steels, High Speed,	
Annealed	15-25
Water Hardening,	
Annealed	50
Ultra High Strength Steels	
Annealed	35
Normalized	20
Tempered	3-7
Maraging Steels	
Annealed	20-15
Maraged	5-10
Tantalum Alloys	
Stress Relieved	3
Titanium Alloys,	
Commercial Pure,	40-60
Alpha & Alpha Beta Alloys,	10-25
Annealed	
Tungsten Alloys, Pressed & Sintered	50
Zinc Alloys	
Die Cast	150

CONVERSION TABLE

Surface Feet Per Minute to Revolutions Per Minute

SFM	20	25	30	40	50	60	70	80	90	100	110	120	130	140	150
TAP SIZE	REVOLUTIONS PER MINUTE														
0	1270	1590	1910	2540	3100	3850	4450	5100	5750	6350	7000	7650	8200	8900	9550
1	1040	1310	1550	2100	2600	3140	3650	4150	4710	5200	5750	6250	6800	7300	7850
2	850	1100	1300	1750	2250	2650	3100	3550	4000	4450	4850	5350	5750	6200	6650
3	750	950	1150	1550	1900	2300	2700	3050	3450	3850	4250	4600	5000	5400	5750
4	650	850	1050	1350	1700	2050	2300	2700	3050	3400	3750	4100	4450	4750	5100
5	600	750	900	1200	1550	1850	2100	2400	2750	3100	3350	3650	3950	4250	4550
6	550	650	850	1100	1350	1650	1950	2200	2450	2750	3050	3300	3600	3850	4150
8	450	580	700	950	1150	1400	1650	1850	2100	2350	2550	2800	3000	3250	3500
10	400	500	600	800	1005	1200	1400	1600	1800	2000	2200	2400	2600	2800	3000
12	350	450	550	700	850	1050	1250	1400	1550	1750	1950	2100	2300	2450	2650
1/4	300	380	450	600	750	900	1050	1200	1350	1500	1650	1800	1950	2150	2300
5/16	250	300	350	480	600	750	850	950	1100	1250	1350	1450	1550	1700	1850
3/8	200	250	300	400	500	600	700	800	900	1000	1100	1200	1300	1400	1500
7/16	170	210	250	350	450	520	600	700	750	850	950	1050	1150	1250	1300
1/2	150	190	220	300	350	450	530	600	650	750	850	900	950	1050	1150
9/16	130	170	200	250	350	400	450	550	600	650	750	800	900	950	1050
5/8	120	150	180	250	300	350	400	450	550	600	650	750	800	850	900
3/4	100	120	150	200	250	300	350	400	450	500	550	600	650	700	750
7/8	80	100	130	170	200	250	300	350	400	450	480	520	550	600	650
1	70	90	100	150	190	230	260	300	350	380	420	450	500	530	570

The material being tapped is the primary factor in determining the most effective TAPPING SPEED. However there are a number of other factors which may require consideration. Among these are: thread pitch, thread length, percent of thread, lubrication, tap flute style and chamfer, equipment and method of tapping. The best speed is determined by experiment on the job. The table below lists speeds which have proven satisfactory under average conditions.

TAP NOMENCLATURE

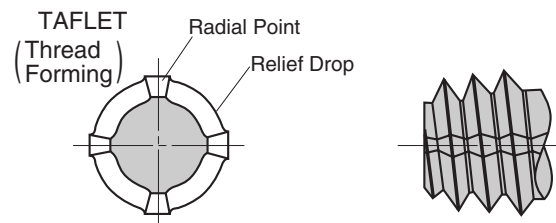
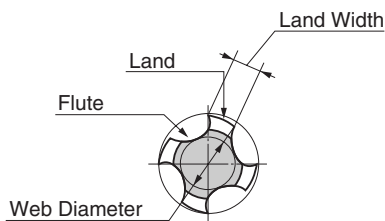
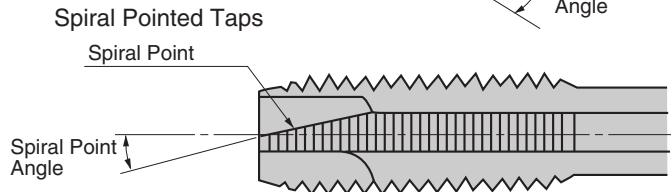
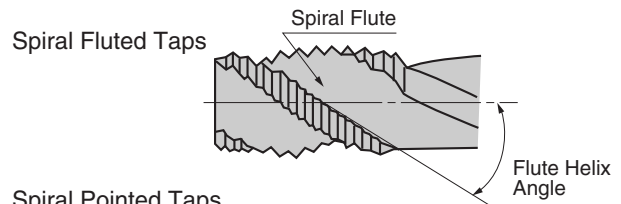
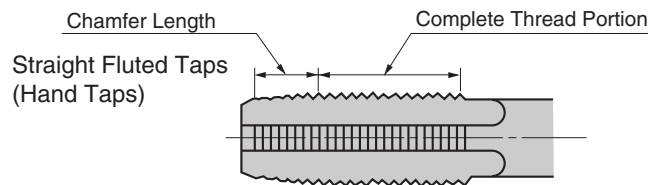
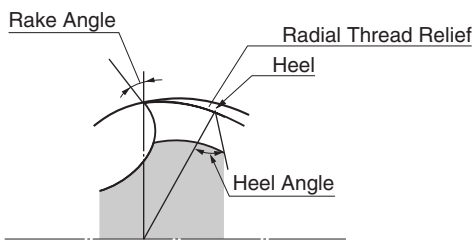
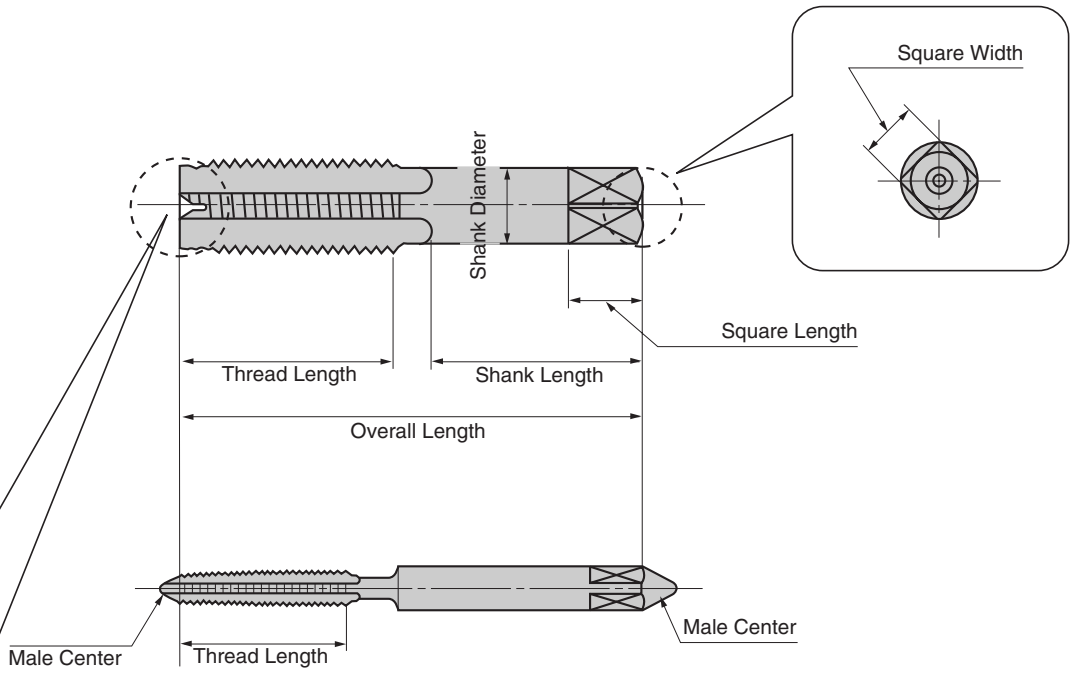

Technical Data

DRILLS

DRILLS
Cutting Condition

END MILLS

END MILLS
Cutting Condition

TAPS

TAPS
Cutting Condition

Others

STANDARDS & DIMENSIONS

Standard System of Marking

General

Taps, dies, and other threading tools will be marked with the nominal size, number of threads per inch, and the proper symbol to identify the thread form. These symbols are in agreement with the ANSI B94.9 1979 Standard on Nomenclature, Definitions and Letter Symbols for Screw Threads.

Symbols used for American Threads are: Symbol Reference

NC	American National Coarse Thread Series
NF	American National Fine Thread Series
NEF	American National Extra Fine Thread Series
N	American National 8, 12 and 16 Thread Series (8N, 12N, 16N)
NH	American (National) Hose Coupling and Fire Hose Coupling Threads
NM	National Miniature Screw Thread
NGO	American (National) Gas Outlet Thread
NS	American Special Thread
NPT	American (National) Taper Pipe Thread
NPTF	Dryseal American (National) Taper Pipe Thread
ANPT	Military Aeronautical Pipe Thread Specification MIL-P-71 05
NPS	American (National) Straight Pipe Thread
NPSC	American (National) Straight Pipe Thread in Pipe Couplings
NPSF	Dryseal American (National) Fuel Internal Straight Pipe Thread
NPSH	American (Standard) Straight Pipe Thread for Hose Couplings and Nipples
NPSI	Dryseal American (National) Intermediate Internal Straight Pipe Thread
NPSL	American (National) Internal Straight Pipe Thread for Locknut Connections (Loose Fitting Mechanical Joints)
NPSM	American (National) Internal Straight Pipe Thread for Mechanical Joints (Free Fitting)
NPTR	American (National) Internal Taper Pipe Thread for Railing Joints (Mechanical Joints)
AMO	American Standard Microscope Objective Thread
ACME C	Acme Screw Thread — Centralizing Type
ACME G	Acme Screw Thread — General Purpose Type
STUB ACME	Stub Acme Threads

NBUTT National Buttress Screw Thread

V A 60° "V" Thread with Truncated Crests and Roots. The Theoretical "V" Form is usually flatted several thousandths of an inch to the user's specifications.

SB Manufacturers Stovebolt Standard Thread

STI Special Threads for Helical Coil Wire Screw Thread Inserts.

Group Thread Taps — Limit Numbers

All standard Ground Thread Taps will be marked with the letter G to designate Ground Thread. The letter G will be followed by the letter H to designate above basic (L below basic) and a numeral to designate the Pitch Diameter limits.

Example: GH3 indicates a Group thread Tap with Pitch Diameter limits .0010 to .0015 over basic.

Pitch Diameter limits for Taps to 1" diameter inclusive.

L1 = Basic to Basic minus .0005

H1 = Basic to Basic plus .0005

H2 = Basic plus .0005 to Basic plus .0010

H3 = Basic plus .0010 to Basic plus .0015

H4 = Basic plus .0015 to Basic plus .0020

H5 = Basic plus .0020 to Basic plus .0025

H6 = Basic plus .0025 to Basic plus .0030

Pitch Diameter limits for Taps over 1" diameter to 1 1/2" diameter inclusive.

H4 = Basic plus .0010 to Basic plus .0020

American National 8, 12, 16 and NEF Thread Series

National 8 pitch Series 1" to 2 1/4" by 1/8ths
2 1/4" to 6" by 1/4ths

National 12 pitch Series 1/2" to 1 1/2" 1/16ths
1 1/2" to 4" by 1/8ths
4" to 6" by 1/4ths

National 16 pitch Series 3/4" to 2 1/2" by 1/16ths
2 1/2" to 4" by 1/8ths
4" to 6" by 1/4ths

National Extra Fine Thread Series

#12	—32	1 1/6"	—18
1/4"	—32	1 1/16"	—18
5/16"	—32	1 1/8"	—18
3/8"	—32	1 3/16"	—18
7/16"	—28	1 1/4"	—18
1/2"	—28	1 5/16"	—18
9/16"	—24	1 3/8"	—18
5/8"	—24	1 7/16"	—18
11/16"	—24	1 1/2"	—18
3/4"	—20	1 9/16"	—18
13/16"	—20	1 5/8"	—18
7/8"	—20	1 11/16"	—18
15/16"	—20	1 3/4"	—16
1"	—20	2"	—16

Technical Data

DRILLS

DRILLS
Cutting Condition

END MILLS

END MILLS
Cutting Condition

TAPS

TAPS
Cutting Condition

Others

STANDARD TAP BLANK DIMENSIONS

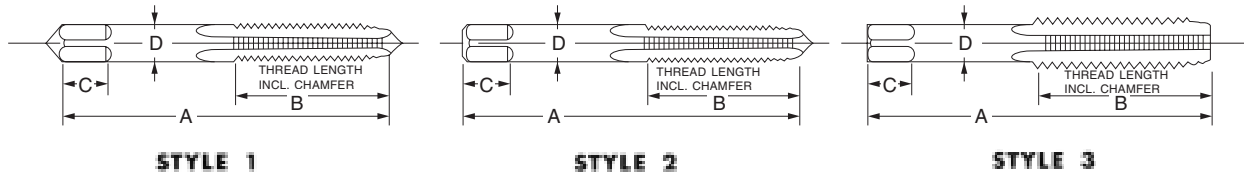

TABLE 302 — GENERAL DIMENSIONS

Nominal Diameter Range - Inches		Mach. Screw 5size No.	Nominal Fractional Diameter Inches	Nominal Metric Diameter Mill.	Style*	Tap Dimensions — Inches				
Over	To (Incl)					Overall Length A	Thread Length B	Square Length C	Shank Diameter D	Size of Square
.052	.065	0	1/16	M1.6	1	1-5/8	5/16	3/16	.141	.110
.065	.078	1		M1.8	1	1-11/16	3/8	3/16	.141	.110
.078	.091	2		M2,MZ2	1	1-3/4	7/16	3/16	.141	.110
.091	.104	3	3/32	M2.5	1	1-13/16	1/2	3/16	.141	.110
.104	.117	4			1	1-7/8	9/16	3/16	.141	.110
.117	.130	5	1/8	M3, M3.15	1	1-15/16	5/8	3/16	.141	.110
.130	.145	6		M3.5	1	2	11/16	3/16	.141	.110
.145	.171	8	5/32	M4	1	2-1/8	3/4	1/4	.168	.131
.171	.197	10	3/16	M4.5, M5	1	2-3/8	7/8	1/4	.194	.152
.197	.223	12	7/32		1	2-3/8	15/16	9/32	.220	.165
.223	.260	14	1/4	M6, M6.3	2	2-1/2	1	5/16	.255	.191
.260	.323		5/16	M7, M8	2	2-23/32	1 1/8	3/8	.318	.238
.323	.385		3/8	M10	2	2-15/16	1 1/4	7/16	.381	.286
.385	.448		7/16		3	3-5/32	1 7/16	13/32	.323	.242
.448	.510		1/2	M12 M12.5	3	3-3/8	1 21/32	7/16	.367	.275
.510	.573		9/16	M14	3	3-19/32	1 21/32	1/2	.429	.322
.573	.635		5/8	M16	3	3-13/16	1 13/16	9/16	.480	.360
.635	.709		11/16	M18	3	4-1/32	1 13/16	5/8	.542	.406
.709	.760		3/4		3	4-1/4	2	11/16	.590	.442
.760	.823		13/16	M20	3	4-15/32	2	11/16	.652	.489
.823	.885		7/8	M22	3	4-11/16	2 7/32	3/4	.697	.523
.885	.948		15/16	M24	3	4-29/32	2 7/32	3/4	.760	.570
.948	1.010		1	M25	3	5-1/8	2 1/2	13/16	.800	.600
1.010	1.073		1 1/16	M27	3	5-1/8	2 1/2	7/8	.896	.672
1.073	1.135		1 1/8		3	5-7/16	2 9/16	7/8	.896	.672
1.135	1.198		1 3/16	M30	3	5-7/16	2 9/16	1	1.021	.766
1.198	1.260		1 1/4		3	5-3/4	2 9/16	1	1.021	.766
1.260	1.323		1 5/16	M33	3	5-3/4	2 9/16	1 1/16	1.108	.831
1.323	1.385		1 3/8		3	6-1/16	3	1 1/16	1.108	.831
1.385	1.448		1 7/16	M36	3	6-1/16	3	1 1/8	1.233	.925
1.448	1.510		1 1/2		3	6-3/8	3	1 1/8	1.233	.925
1.510	1.635		1 5/8	M39	3	6-11/16	3 3/16	1 1/8	1.305	.979
1.635	1.760		1 3/4	M42	3	7	3 3/16	1 1/4	1.430	1.072
1.760	1.885		1 7/8		3	7-5/16	3 9/16	1 1/4	1.519	1.139
1.885	2.010		2	M48	3	7-5/8	3 9/16	1 3/8	1.644	1.233
2.010	2.135		2 1/8		3	8	3 9/16	1 3/8	1.769	1.327
2.135	2.260		2 1/4	M56	3	8 1/4	3 9/16	1 7/16	1.894	1.420
2.260	2.385		2 3/8		3	8 1/2	4	1 7/16	2.019	1.514
2.385	2.510		2 1/2		3	8 3/4	4	1 1/2	2.100	1.575
2.510	2.635		2 5/8	M64	3	8 3/4	4	1 1/2	2.225	1.669
2.635	2.760		2 3/4		3	9 1/4	4	1 9/16	2.350	1.762
2.760	2.885		2 7/8	M72	3	9 1/4	4	1 9/16	2.475	1.856
2.885	3.010		3		3	9 3/4	4 9/16	1 5/8	2.543	1.907
3.010	3.135		3 1/8		3	9 3/4	4 9/16	1 5/8	2.668	2.001
3.135	3.260		3 1/4	M80	3	10	4 9/16	1 3/4	2.793	2.095
3.260	3.385		3 3/8		3	10	4 9/16	1 3/4	2.883	2.162
3.385	3.510		3 1/2		3	10 1/4	4 15/16	2	3.008	2.256
3.510	3.635		3 5/8	M90	3	10 1/4	4 15/16	2	3.133	2.350
3.635	3.760		3 3/4		3	10 1/2	5 5/16	2 1/8	3.217	2.413
3.760	3.885		3 7/8		3	10 1/2	5 5/16	2 1/8	3.342	2.506
3.885	4.010		4	M100	3	10 3/4	5 5/16	2 1/4	3.467	2.600

* Styles shown are for ground thread taps

Technical Data

DRILLS

DRILLS Cutting Condition

END MILLS

END MILLS Cutting Condition

TAPS

TAPS Cutting Condition

Others

TAP RECOMMENDATION FOR CLASSES 2B & 3B UNIFIED INCH SCREW THREADS

Size	Threads Per Inch		Recommended Tap Limits		Internal Thread Pitch Diameter Units		
	NC UNC	NF UNF	Class 2B	Class 3B	Min. All Classes (BASIC)	Max. Class 2B	Max. Class 3B
0	–	80	H2	H1	.0519	.0542	.0536
1	64	–	H2	H1	.0629	.0655	.0648
1	–	72	H2	H1	.0640	.0665	.0659
2	56	–	H2	H1	.0744	.0772	.0765
2	–	64	H2	H1	.0759	.0786	.0779
3	48	–	H2	H1	.0855	.0885	.0877
3	–	56	H2	H1	.0874	.0902	.0895
4	40	–	H2	H2	.0958	.0991	.0982
4	–	48	H2	H1	.0985	.1016	.1008
5	40	–	H2	H2	.1088	.1121	.1113
5	–	44	H2	H1	.1102	.1134	.1126
6	32	–	H3	H2	.1177	.1214	.1204
6	–	40	H2	H2	.1218	.1252	.1243
8	32	–	H3	H2	.1437	.1475	.1465
8	–	36	H2	H2	.1460	.1496	.1487
10	24	–	H3	H3	.1629	.1672	.1661
10	–	32	H3	H2	.1697	.1736	.1726
12	24	–	H3	H3	.1889	.1933	.1922
12	–	28	H3	H3	.1928	.1970	.1959
1/4	20	–	H5	H3	.2175	.2223	.2211
1/4	–	28	H4	H3	.2268	.2311	.2300
5/16	18	–	H5	H3	.2764	.2817	.2803
5/16	–	24	H4	H3	.2854	.2902	.2890
3/8	16	–	H5	H3	.3344	.3401	.3387
3/8	–	24	H4	H3	.3479	.3528	.3516
7/16	14	–	H5	H3	.3911	.3972	.3957
7/16	–	20	H5	H3	.4050	.4104	.4091
1/2	13	–	H5	H3	.4500	.4565	.4548
1/2	–	20	H5	H3	.4675	.4731	.4717
9/16	12	–	H5	H3	.5084	.5152	.5135
9/16	–	18	H5	H3	.5264	.5323	.5308
5/8	11	–	H5	H3	.5660	.5732	.5714
5/8	–	18	H5	H3	.5889	.5949	.5934
3/4	10	–	H5	H5	.6850	.6927	.6907
3/4	–	16	H5	H3	.7094	.7159	.7143
7/8	9	–	H6	H4	.8028	.8110	.8089
7/8	–	14	H6	H4	.8286	.8356	.8339
1	8	–	H6	H4	.9188	.9276	.9254
1	–	12	H6	H4	.9459	.9535	.9516
1	14 NS		H6	H4	.9536	.9609	.9590
1 1/8	7	–	H8	H4	1.0332	1.0416	1.0393
1 1/8	–	12	H6	H4	1.0709	1.0787	1.0768
1 1/4	7	–	H8	H4	1.1572	1.1668	1.1644
1 1/4	–	12	H6	H4	1.1959	1.2039	1.2019
1 3/8	6	–	H8	H4	1.2667	1.2771	1.2745
1 3/8	–	12	H6	H4	1.3209	1.3291	1.3270
1 1/2	6	–	H8	H4	1.3917	1.4022	1.3996
1 1/2	–	12	H6	H4	1.4459	1.4542	1.4522

The above recommended taps normally produce the Class of Thread indicated average materials when used with reasonable care. However, if the tap specified does not give a satisfactory gage fit in the work, a choice of some other limit tap will be necessary.

PRE-TAPPING DRILLING SIZES

Drilling size is strictly concerned Percent of Thread. The following picture shows the relations between the height of the female thread and its sectional area. Here, it's very important to choose the minimized Percent of Thread as possible the thread needs. Because too much Percent of Thread brings increased cutting torque which causes excess wear and breakage of the taps.

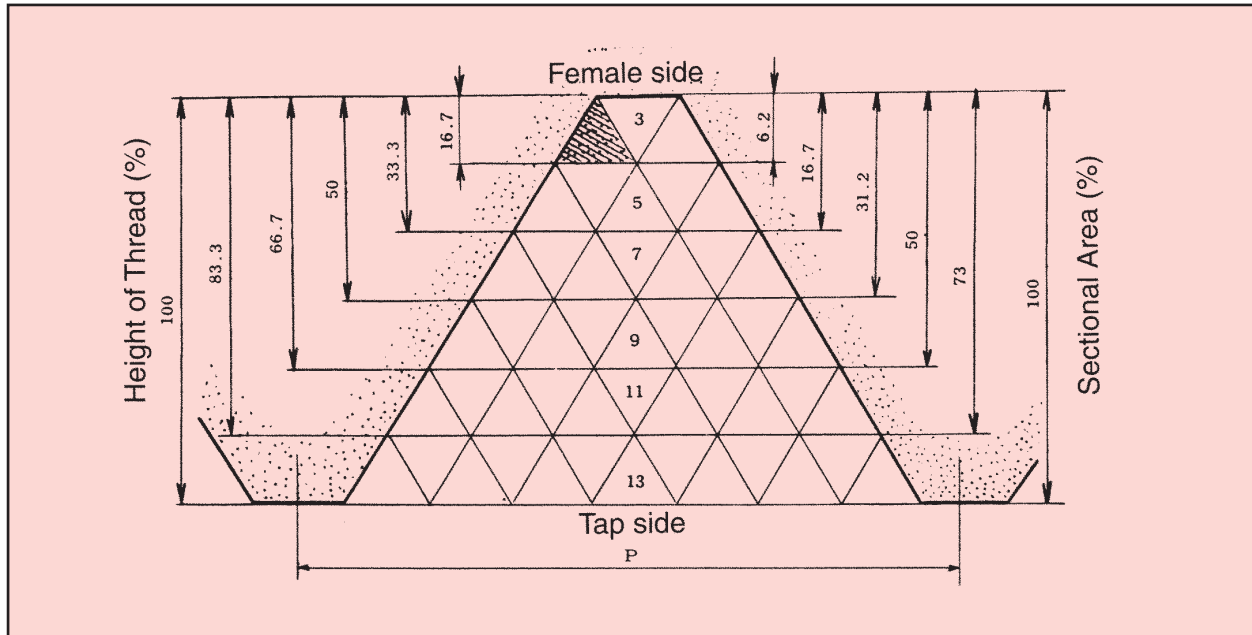

$$\text{Percent of Thread} = \frac{\text{Basic thread OD.} \times \text{Pre-Tapping Diameter}}{2 \times (\text{Basic Height of Thread})} \times 100\%$$

- Pre-tapping diameter for Cutting Taps

$$\text{Pre-tapping Diameter} = \text{Basic thread OD.} - \frac{.01299 \times \text{Percent of Thread}}{\text{No. of threads per inch}}$$

- Pre-tapping Diameter for Roll Forming Taps

$$\text{Pre-tapping Diameter} = \text{Basic thread OD.} - \frac{.0068 \times \text{Percent of Thread}}{\text{No. of threads per inch}}$$

Technical
Data

DRILLS

DRILLS
Cutting Condition

END MILLS

END MILLS
Cutting Condition

TAPS

TAPS
Cutting Condition

Others

TAP DRILL SIZES

The following tables show the Theoretical Percentage of Thread obtained from stock sizes of drills and also the Probable Percentage after allowance for oversize drilling.

Tap	Tap Drill	Decimal Equiv. of Tap Drill	Probable Hole Size	Percent of Thread	Tap	Tap Drill	Decimal Equiv. of Tap Drill	Probable Hole Size	Percent of Thread	Tap	Tap Drill	Decimal Equiv. of Tap Drill	Probable Hole Size	Percent of Thread
0-80	56	.0465	.0480	74	8-32	29	.1360	.1389	62	3/8-16	5/16	.3125	.3160	72
	3/64	.0469	.0484	71		28	.1405	.1434	51		O	.3160	.3204	68
	54	.0550	.0565	81		29	.1360	.1389	70		P	.3230	.3274	59
1-64	53	.0595	.0610	59	8-36	28	.1405	.1434	57	3/8-24	21/64	.3281	.3325	79
	53	.0595	.0610	67		9/64	.1406	.1435	57		Q	.3320	.3364	71
1-72	1/16	.0625	.0640	50	10-24	27	.1440	.1472	79	7/16-14	R	.3390	.3434	58
	51	.0670	.0687	74		26	.1470	.1502	74		T	.3580	.3626	81
2-56	50	.0700	.0717	62	10-32	25	.1495	.1527	69	7/16-20	23/64	.3594	.3640	79
	49	.0730	.0747	49		24	.1520	.1552	64		U	.3680	.3726	70
2-64	50	.0700	.0717	70	10-32	23	.1540	.1572	61	7/16-20	3/18	.3750	.3796	62
	49	.0730	.0747	56		5/32	.1563	.1595	56		V	.3770	.3816	60
3-48	48	.0760	.0779	78	10-32	22	.1570	.1602	55	1/2-13	W	.3860	.3906	72
	5/64	.0781	.0800	70		5/32	.1563	.1595	75		25/64	.3906	.3952	65
3-56	47	.0785	.0804	69	12-24	22	.1570	.1602	73	1/2-20	X	.3970	.4016	55
	46	.0810	.0829	60		21	.1590	.1622	68		27/64	.4219	.4216	73
3-56	45	.0820	.0839	56	12-24	20	.1610	.1642	64	9/16-12	7/16	.4375	.4422	58
	46	.0810	.0829	69		19	.1660	.1692	51		29/64	.4531	.4578	65
4-40	45	.0820	.0839	65	12-28	11/64	.1719	.1754	75	9/16-18	15/32	.4688	.4736	82
	44	.0860	.0880	74		17	.1730	.1765	73		31/64	.4844	.4892	68
4-48	44	.0860	.0880	74	12-28	16	.1770	.1805	66	5/8-11	1/2	.5000	.5048	80
	43	.0890	.0910	65		15	.1800	.1835	60		33/64	.5156	.5204	58
4-48	42	.0935	.0955	55	12-28	14	.1820	.1855	56	5/8-18	17/32	.5313	.5362	75
	3/32	.0938	.0958	50		16	.1770	.1805	77		35/64	.5469	.5518	62
5-40	42	.0935	.0955	61	1/4-20	15	.1800	.1835	70	3/4-10	9/16	.5625	.5674	80
	3/32	.0938	.0958	60		14	.1820	.1855	66		37/64	.5781	.5831	58
5-44	41	.0960	.0980	52	1/4-20	13	.1850	.1885	59	7/8-9	41/64	.6406	.6456	80
	40	.0980	.1003	76		3/16	.1875	.1910	54		21/32	.6563	.6613	68
5-44	39	.0995	.1018	71	1/4-20	9	.1960	.1998	77	7/8-14	11/16	.6875	.6925	71
	38	.1015	.1038	65		8	.1990	.2028	73		49/64	.7656	.7708	72
6-32	37	.1040	.1063	58	1/4-28	7	.2010	.2048	70	1"-8	25/32	.7812	.7864	61
	38	.1015	.1038	72		13/64	.2031	.2069	66		51/64	.7969	.8021	79
6-32	37	.1040	.1063	78	1/4-28	6	.2040	.2078	65	1"-8	13/16	.8125	.8177	62
	36	.1065	.1088	55		5	.2055	.2093	63		55/64	.8594	.8653	83
6-40	37	.1040	.1063	78	5/16-18	4	.2090	.2128	57	1"-12	7/8	.8750	.8809	73
	36	.1065	.1091	71		3	.2130	.2168	72		57/64	.8906	.8965	64
6-40	7/64	.1094	.1120	64	5/16-18	7/32	.2188	.2226	59	1"-14	29/32	.9063	.9123	54
	35	.1100	.1126	63		2	.2210	.2248	55		29/32	.9063	.9123	81
6-40	34	.1110	.1136	60	5/16-24	F	.2570	.2608	72	1"-14	59/64	.9219	.9279	67
	33	.1130	.1156	55		G	.2610	.2651	66		15/16	.9375	.9435	52
6-40	34	.1110	.1136	75	5/16-24	17/64	.2656	.2697	59	1"-14	59/64	.9219	.9279	78
	33	.1130	.1156	69		H	.2660	.2701	59		15/16	.9375	.9435	61
	32	.1160	.1186	60		I	.2720	.2761	67					

FORMULA FOR OBTAINING TAP DRILL SIZES

(Select nearest commercial stock drill)

$$\left\{ \begin{array}{l} \text{Outside Diam.} \\ \text{of Thread} \end{array} \right\} \text{ minus } \left\{ \frac{.01299 \text{ Amount of percentage of full thread}}{\text{Number of threads per inch}} \right\} = \text{Drilled Hole Size}$$

$$\left\{ \begin{array}{l} \text{No. of Threads} \\ \text{per inch} \end{array} \right\} \times \left\{ \frac{\text{Outside Diam. of thread-Selected Drill Diam}}{.01299} \right\} = \text{Percentage of full Thread}$$

Technical Data

DRILLS

DRILLS Cutting Condition

END MILLS

END MILLS Cutting Condition

TAPS

TAPS Cutting Condition

Others

TAP DRILL SIZES

For Thread Forming Taps

Nominal Size	Threads per Inch		75% THREAD			70% THREAD			65% THREAD			60% THREAD		
			Theor. Hole Core Size	Nearest Drill Size	Dec. Equiv.	Theor. Hole Core Size	Nearest Drill Size	Dec. Equiv.	Theor. Hole Core Size	Nearest Drill Size	Dec. Equiv.	Theor. Hole Core Size	Nearest Drill Size	Dec. Equiv.
	NC UNC	NF UNF												
0	—	80	.0536	1.35mm	.0531	.0540	1.35mm	.0531	.0545	—	—	.0549	54	.0550
1	64	—	.0650	1.65mm	.0650	.0655	1.65mm	.0650	.0661	—	—	.0666	—	—
1	—	72	.0659	1.65mm	.0650	.0663	—	—	.0669	1.7mm	.0669	.0673	51	.0670
2	56	—	.0769	1.95mm	.0768	.0774	1.95mm	.0768	.0781	3/64	.0781	.0787	47	.0785
2	—	64	.0780	5/64	.0781	.0785	47	.0785	.0791	2.0mm	.0787	.0796	2.0mm	.0787
3	48	—	.0884	2.25mm	.0886	.0890	43	.0890	.0898	43	.0890	.0905	2.3mm	.0906
3	—	56	.0899	43	.0890	.0904	—	—	.0911	2.3mm	.0906	.0917	2.3mm	.0906
4	40	—	.0993	2.5mm	.0984	.1000	39	.0995	.1010	39	.0995	.1018	38	.1015
4	—	48	.1014	38	.1015	.1020	38	.1015	.1028	2.6mm	.1024	.1035	2.6mm	.1024
5	40	—	.1123	34	.1110	.1130	33	.1130	.1140	33	.1130	.1148	2.9mm	.1142
5	—	44	.1134	33	.1130	.1141	2.9mm	.1142	.1150	2.9mm	.1142	.1157	—	—
6	32	—	.1221	2.1mm	.1220	.1230	3.1mm	.1220	.1243	—	—	.1252	1/8	.1250
6	—	40	.1253	1/8	.1250	.1260	3.2mm	.1260	.1270	3.2mm	.1260	.1278	3.25mm	.1280
8	32	—	.1481	3.75mm	.1476	.1490	—	—	.1503	25	.1495	.1512	3.8mm	.1496
8	—	36	.1498	25	.1495	.1507	3.8mm	.1496	.1518	24	.1520	.1526	24	.1520
10	24	—	.1688	—	—	.1700	18	.1695	.1717	11/64	.1719	.1729	11/64	.1719
10	—	32	.1741	17	.1730	.1750	—	—	.1763	—	—	.1772	16	.1770
12	24	—	.1948	10	.1935	.1960	9	.1960	.1977	5.0mm	.1968	.1989	8	.1990
12	—	28	.1978	5.0mm	.1968	.1989	8	.1990	.2003	8	.1990	.2014	7	.2010
1/4	20	—	.2245	5.7mm	.2244	.2260	—	—	.2280	1	.2280	.2295	1	.2280
1/4	—	28	.2318	—	—	.2329	5.9mm	.2323	.2343	A	.2340	.2354	15/64	.2344
5/16	18	—	.2842	7.2mm	.2835	.2861	7.25mm	.2854	.2879	7.3mm	.2874	.2898	L	.2900
5/16	—	24	.2912	7.4mm	.2913	.2927	—	—	.2941	M	.2950	.2955	7.5mm	.2953
3/8	16	—	.3431	11/32	.3437	.3452	8.75mm	.3445	.3474	S	.3480	.3495	8.9mm	.3504
3/8	—	24	.3537	9.0mm	.3543	.3552	9.0mm	.3543	.3566	—	—	.3580	T	.3580
7/16	14	—	.4011	—	—	.4035	Y	—	.4059	13/32	—	.4084	—	—
7/16	—	20	.4120	Z	—	.4137	10.5mm	—	.4154	—	—	.4171	—	—
1/2	13	—	.4608	—	—	.4634	—	—	.4660	—	—	.4686	15/32	—
1/2	—	20	.4745	—	—	.4762	—	—	.4779	—	—	.4796	—	—
9/16	12	—	.5200	—	—	.5229	—	—	.5257	—	—	.5285	—	—
9/16	—	18	.5342	13.5mm	.5315	.5361	—	—	.5380	—	—	.5398	—	—
5/8	11	—	.5787	37/64	.5781	.5817	37/64	.5781	.5848	—	—	.5879	—	—
5/8	—	18	.5967	19/32	.5937	.5986	—	—	.6004	—	—	.6023	—	—
3/4	10	—	.6990	—	—	.7024	—	—	.7058	45/64	.7031	.7092	18.0mm	.7087
3/4	—	16	.7181	23/32	.7187	.7202	23/32	.7187	.7224	—	—	.7245	—	—

For Pipe Taps

Nominal Pipe Size	Threads Per Inch	NPT–NPTF (When Drilled Only)		NPT–NPTF–ANPT (When Taper Reamed)		NPS–NPSF	
		Dr. Size	Dec. Equiv.	Dr. Size	Dec. Equiv.	Dr. Size	Dec. Equiv.
1/16	27	D	.2460	15/64	.2344	1/4	.2500
1/8	27	R	.3390	21/64	.3281	11/32	.3438
1/4	18	7/16	.4375	27/64	.4219	7/16	.4375
3/8	18	37/64	.5781	9/16	.5625	37/64	.5781
1/2	14	45/64	.7031	11/16	.6875	23/32	.7188
3/4	14	59/64	.9219	57/64	.8906	59/64	.9218
1	11-1/2	1 5/32	1.1562	1 1/8	1.1250	1 5/32	1.1562
1 1/4	11-1/2	1 1/2	1.5000	1 15/32	1.4688		
1 1/2	11-1/2	1 47/64	1.7344	1 45/64	1.7031		
2	11-1/2	2 7/32	2.2188	2 3/16	2.1875		

Technical Data

DRILLS

DRILLS
Cutting Condition

END MILLS

END MILLS
Cutting Condition

TAPS

TAPS
Cutting Condition

Others

Technical
Data

DRILLS

DRILLS
Cutting
Condition

END MILLS

END MILLS
Cutting
Condition

TAPS

TAPS
Cutting
Condition

Others

TAP DRILL SIZES (METRIC)

For Cutting Taps

Unit : mm

Nominal size	Pitch	Percentage of thread engagement hole diameter				Minor dia of internal thread
		100%	90%	80%	70%	
M2	0.4	1.57	1.61	1.65	1.7	1.567~1.679
M3	0.5	2.46	2.51	2.57	2.62	2.459~2.599
M3.5	0.6	2.85	2.92	2.98	3.05	2.850~3.010
M4	0.7	3.24	3.32	3.39	3.47	3.242~3.422
M5	0.8	4.13	4.22	4.31	4.39	4.134~4.334
M6	1	4.92	5.03	5.13	5.24	4.917~5.153
M7	1	5.92	6.03	6.13	6.24	5.917~6.153
M8	1.25	6.65	6.78	6.92	7.05	6.647~6.912
	1	6.92	7.03	7.13	7.24	6.917~7.153
M10	1.5	8.38	8.54	8.7	8.86	8.376~8.676
	1.25	8.65	8.78	8.92	9.05	8.647~8.912
M12	1.75	10.11	10.3	10.5	10.7	10.106~10.441
	1.25	10.65	10.78	10.92	11.05	10.647~10.912
M14	2	11.8	12.1	12.3	12.5	11.835~12.210
	1.25	12.65	12.78	12.92	13.05	12.647~19.912

Nominal size	Pitch	Percentage of thread engagement hole diameter				Minor dia of internal thread
		100%	90%	80%	70%	
M16	2	13.8	14.1	14.3	14.5	13.835~14.210
	1.5	14.38	14.54	14.7	14.86	14.376~14.676
M18	2.5	15.3	15.6	15.8	16.1	15.294~15.744
	1.5	16.38	16.54	16.7	16.86	16.376~16.676
M20	2.5	17.3	17.6	17.8	18.1	17.294~17.744
	1.5	18.38	18.54	18.7	18.86	18.376~18.676
M22	2.5	19.3	19.6	19.8	20.1	19.264~19.744
	1.5	20.38	20.54	20.7	20.86	20.367~20.676
M24	3	20.8	21.1	21.4	21.7	20.752~21.252
	1.5	22.38	22.54	22.7	22.86	22.376~22.676
M27	3	23.8	24.1	24.4	24.7	23.752~24.252
M30	3.5	26.2	26.6	27.0	27.3	26.211~26.711

For Thread Forming Taps

Unit : mm

Nominal size	Pitch	Percentage of thread engagement hole diameter			
		100%	90%	80%	70%
M2	0.4	1.77	1.80	1.82	1.84
M2.2	0.45	1.94	1.97	2.00	2.02
M2.5	0.45	2.24	2.27	2.30	2.32
M3	0.5	2.72	2.74	2.77	2.80
M3.5	0.6	3.16	3.19	3.23	3.26
M4	0.7	3.60	3.64	3.68	3.72
M4.5	0.75	4.07	4.12	4.16	4.20
M5	0.8	4.55	4.59	4.64	4.68
M6	1	5.43	5.49	5.55	5.60
M7	1	6.43	6.49	6.55	6.60
M8	1.25	7.29	7.36	7.43	7.50
	1	7.43	7.49	7.55	7.60

Nominal size	Pitch	Percentage of thread engagement hole diameter			
		100%	90%	80%	70%
M10	1.5	9.15	9.23	9.32	9.40
	1.25	9.29	9.36	9.43	9.50
M12	1.75	11.01	11.11	11.21	11.31
	1.25	11.29	11.36	11.43	11.50
M14	2	12.87	12.98	13.09	13.21
	1.5	13.15	13.23	13.32	13.40
M16	2	14.87	14.98	15.09	15.21
	1.5	15.15	15.23	15.32	15.40
M18	2.5	16.58	16.72	16.87	17.01
	1.5	17.15	17.23	17.32	17.40
M20	2.5	18.58	18.72	18.87	19.01
	1.5	19.15	19.23	19.32	19.40

Note:

1. Determine hole diameter by tapping test. The dimensions in this table are for reference only.

THE MANY ADVANTAGES OF NACHI TDT VIPER T-SERIES TAPS

These taps are made of high vanadium E grade high speed steel (HSSEV), which is primarily used for heavy duty taps. The taps are heat treated, followed by a special steam oxide treatment that prevents adhesion. This results in the ability to obtain suitable internal threads from the start, which also extends tap life to more than double that of other taps!

The Specific Advantages

1. Less Oversizing

Taftlet Relief reforms cut threads and controls the thrust of the tap completely. Even if tapped material is mild steel, cutting stops within one thread! High precision uniformity of the tapped limit is obtainable with little oversizing, regardless of the rigidity of the tapping mechanism. Even when slight oversizing occurs, the chip-bite between taps and internal threads gets hard so tap breakage and/or torn threads are reduced.

2. Ideal Flute Shape

All cutting edges on the chamfered portion are at exactly the same angle, so the chip shape is consistent. Smaller than conventional curvature on the bottom flute stretching from the cutting face results in small curled chips. In addition, Nachi Viper T-Series Taps release chips smoothly, thanks to their specially designed helix angle.

3. Shorter Thread Length

Shorter than conventional thread lengths prevent chips from clogging the flutes; reduce bite, twine-round and breakage of the cutting edge. Flute length also provides for excellent chip ejection.

4. GT System For Thread Limit

Instead of the usual GH limits, GT limits are applied to Nachi Viper T-Series Taps. Each top has just one GT number instead of several GH numbers, eliminating troublesome limit selection (see Comparison Chart, below, for details).

COMPARISON OF NACHI GT AND ANSI GH NUMBERS

THREAD TOLERANCE IN TEN THOUSANDTHS OF AN INCH (.0001")

COMPARISON OF NACHI GT AND ANSI GH NUMBERS

THREAD TOLERANCE IN TEN THOUSANDTHS OF AN INCH (.0001")

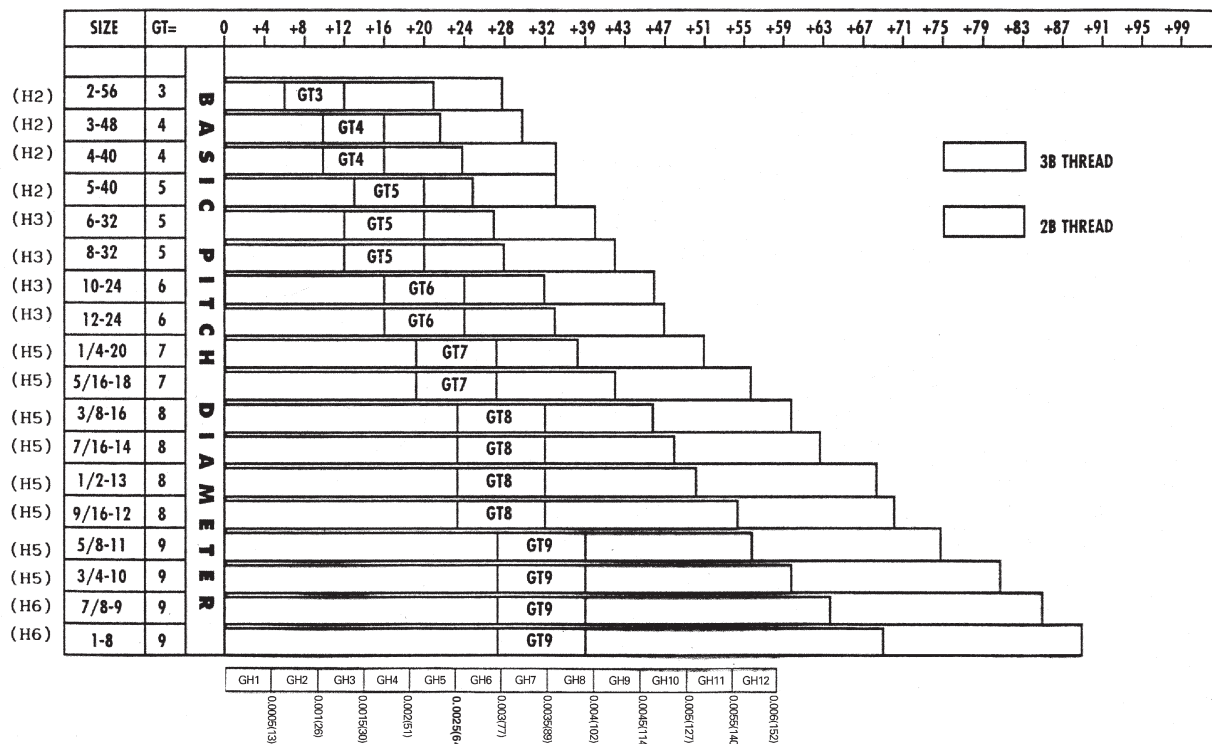

Technical Data

DRILLS

DRILLS Cutting Condition

END MILLS

END MILLS Cutting Condition

TAPS

TAPS Cutting Condition

Others

TAP TOLERANCE TABLE

GT Limits Table

Fractional, Machine screw, and Metric Taps
Over 42 TPI, or less than 0.6mm pitch

Class	MIN	MAX
GT2	0.0002	0.0008
GT3	0.0006	0.0012
GT4	0.0010	0.0016
GT5	0.0014	0.0020
GT6	0.0018	0.0024
GT7	0.0022	0.0028

Fractional, Machine screw, and Metric Taps
Less than 42 TPI, or over 0.6mm pitch

Class	MIN	MAX
GT2	0.0000	0.0008
GT3	0.0004	0.0012
GT4	0.0008	0.0016
GT5	0.0012	0.0020
GT6	0.0016	0.0024
GT7	0.0020	0.0028
GT8	0.0024	0.0031
GT9	0.0028	0.0035
GT10	0.0031	0.0039

GT LIMITS
CONVERSION CHART

Recommended tap limits for 2B and 3B

TAP SIZE	CLASS 2B		CLASS 3B	
	H LIMITS	GT LIMITS	H LIMITS	GT LIMITS
2-56	H2	GT3	H1	-
2-64	H2	GT3	H1	-
3-48	H2	GT4	H1	-
3-56	H2	GT3	H1	-
4-40	H2	GT5	H2	-
4-48	H2	GT4	H1	-
5-40	H2	GT5	H2	-
5-44	H2	GT5	H2	-
6-32	H3	GT5	H2	-
6-40	H2	GT5	H2	-
8-32	H3	GT5	H2	-
8-36	H2	GT5	H2	-
10-24	H3	GT6	H3	-
10-32	H3	GT5	H2	-
12-24	H3	GT6	H3	-
12-28	H3	GT6	H3	-
1/4-20	H5	GT7	H3	GT4
1/4-28	H4	GT6	H3	GT4
5/16-18	H5	GT7	H3	GT4
5/16-24	H4	GT7	H3	GT4
3/8-16	H5	GT8	H3	GT4
3/8-24	H4	GT7	H3	GT4
7/16-14	H5	GT8	H3	GT4
7/16-20	H5	GT8	H3	GT4
1/2-13	H5	GT8	H3	GT4
1/2-20	H5	GT8	H3	GT4
9/16-12	H5	GT8	H3	GT4
9/16-18	H5	GT8	H3	GT4
5/8-11	H5	GT9	H3	GT4
5/8-18	H5	GT8	H3	GT4
3/4-10	H5	GT9	H5	GT4
3/4-16	H5	GT8	H3	GT4
7/8-9	H6	GT9	H4	GT5
7/8-14	H6	GT9	H4	GT5
1-8	H6	GT9	H4	GT5
1-12	H6	GT9	H4	GT5

Technical
Data

DRILLS

DRILLS
Cutting Condition

END MILLS

END MILLS
Cutting Condition

TAPS

TAPS
Cutting Condition

Others

TAP TOLERANCE TABLE

H Limits Table

Fractional and Machine screw types

Class	MIN	MAX
H1	0.0000	0.0005
H2	0.0005	0.0010
H3	0.0010	0.0015
H4	0.0015	0.0020
H5	0.0020	0.0025
H6	0.0025	0.0030
H7	0.0030	0.0035
H8	0.0035	0.0040
H9	0.0040	0.0045
H10	0.0045	0.0050
H11	0.0050	0.0055
H12	0.0055	0.0060

D Limits Table

Metric Taps

Tap Size	D Class	MIN	MAX
M2X0.4	D3	0.0009	0.0015
M2.5X0.45	D3	0.0009	0.0015
M3X0.5	D3	0.0009	0.0015
M3.5X0.6	D4	0.0012	0.0020
M4X0.7	D4	0.0012	0.0020
M5X0.8	D4	0.0012	0.0020
M6X1	D5	0.0015	0.0025
M7X1	D5	0.0015	0.0025
M8X1	D5	0.0015	0.0025
M8X1.25	D5	0.0013	0.0025
M10X1.25	D5	0.0013	0.0025
M10X1.5	D6	0.0018	0.0030
M12X1.25	D5	0.0013	0.0025
M12X1.75	D6	0.0018	0.0030
M14X1.5	D6	0.0018	0.0030
M14X2	D7	0.0019	0.0035
M16X1.5	D6	0.0018	0.0030
M16X2.0	D7	0.0019	0.0035
M18X1.50	D6	0.0018	0.0030
M18X2.5	D7	0.0019	0.0035
M20X2.5	D7	0.0019	0.0035
M22X2.5	D7	0.0019	0.0035
M24X3.0	D8	0.0024	0.0040
M27X3.0	D8	0.0024	0.0040
M30X3.5	D9	0.0025	0.0045

Technical
Data

DRILLS

DRILLS
Cutting Condition

END MILLS

END MILLS
Cutting Condition

TAPS

TAPS
Cutting Condition

Others

RESHARPENING OF TAPS

When to Resharpen Taps

1. When the taps get or appear to be damaged.
2. When the dimensions of the tapped threads begin to get out of tolerance.
3. When the surface roughness on threads decreases.
4. When the cutting torque starts to increase.
5. When the taps start to make a squealing noise.
6. When the shape of the tapping chips begin to change.

A. Flute Grinding Way

1. The following table shows the common grinding condition for resharpening the taps.

Item	General	Mass Production
Wheel Dimension	WA 60–80K	CBN 120–170
Wheel Speed	1970 ft/mm	4,900–5,900 ft/mm
Depth of Grinding	.0012"	.0004–.002"
Feed Rate	3.3 ft/mm	3.3–10.0 ft/min
Coolant	Wet	Wet

The depth of regrind can be 2–3 times the thread height; it is not necessary to regrind full depth of the flute. However, it must be as smooth as possible from the ground rake face position to the root radius.

2. Setting the rake angle

To grind the rake face is to remove wear and the damaged portion.

It is very important to set the rake angle very carefully, otherwise it brings unstable accuracy of female thread, bad surface roughness, short tool life and chipping. The following picture indicates two types of resharpening, which are Grinding Hook Angle by Formed wheel and Grinding Rake Angle by Disk Type wheel.

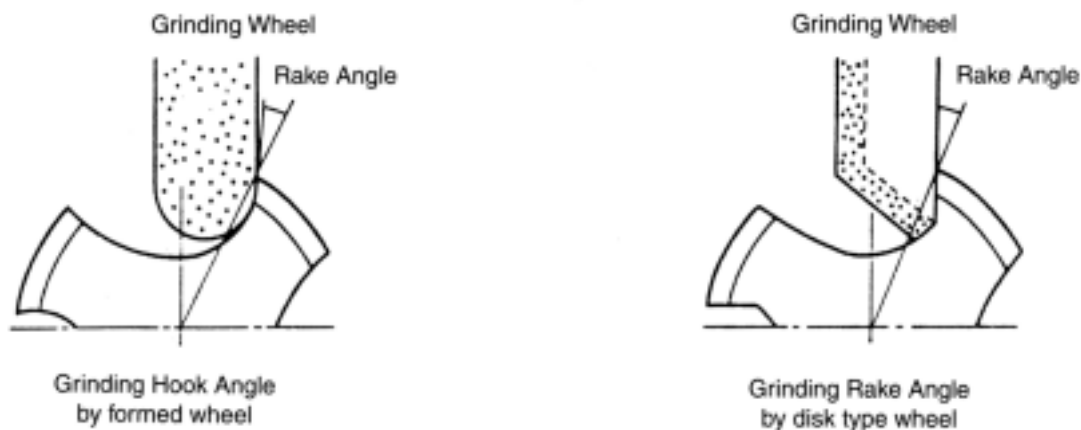

RESHARPENING OF TAPS

B. Chamfer Grinding Way

The Chamfer Grinding is carried out by some chamfer grinding machines with being held by collet or between centers. Chamfer length and angle are specified as follows:

Kind of Taps	Chamfer Length	Chamfer Angle
hand taps (Taper)	8~9 threads	≈4°~5°
hand taps (Plug)	5 threads	≈7.5°
hand taps (Bottoming)	1.5 threads	≈24°
taper pipe taps	2.5 threads	≈15°
parallel pipe taps	4 threads	≈11°
spiral fluted taps	2.5 threads	≈15°
spiral pointed taps	4 threads	≈9.5°

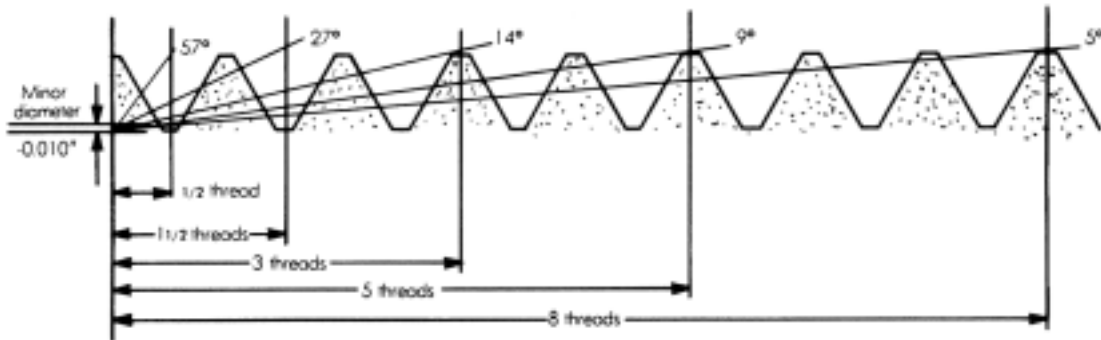

Relation between length and angle of taper

Relief Angle (α) is calculated as next.

$$\alpha = \tan^{-1} (P \times \tan \lambda / \pi d) \cong \alpha_0$$

α : relief angle on taper

P: pitch

λ : taper angle

d: basic minor diameter

α_0 : effective minimum relief angle

α_0 is decided as table

Material	Relief Angle
steel	4 ~ 5
hard steel	2 ~ 3
stainless steel	5°
cast iron	3°
aluminum	6°

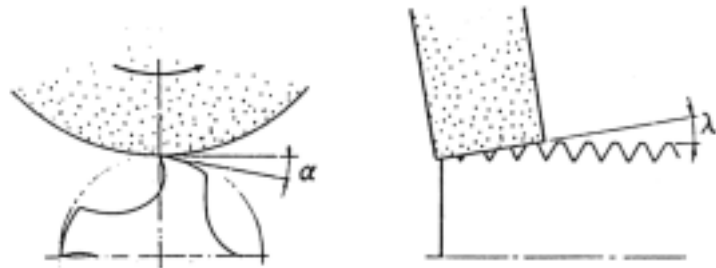

Resharpening of taper

Technical
Data

DRILLS

DRILLS
Cutting Condition

END MILLS

END MILLS
Cutting Condition

TAPS

TAPS
Cutting Condition

Others

TROUBLE-SHOOTING GUIDE FOR TAPPING PROBLEMS

	Troubles	Factors	Countermeasures
Surface Roughness	Torn or Rough Thread	Chamfer length too short	• Increase chamfer length
		Wrong cutting angle	• Apply proper cutting angle
		Galling	• Use thread relieved taps
			• Reduce land width
	Chattering on Tapped Thread	Chip packing	• Apply surface treatment such as steam oxide or chrome
			• Use proper cutting lubricant
		Too free cutting	• Reduce tapping speed
			• Use larger drill size
Dimensional Error	Oversize Pitch Diameter	• Obtain proper alignment between tap and work	
		• Use spiral pointed or spiral fluted taps	
		• Use larger drill size	
		Tool condition	• Avoid too narrow land width
			• Reduce amount of thread relief
		Incorrect Taps	• Reduce cutting angle
	• Do not grind the bottom of the flute		
	Chip Packing	• Use proper GH limits	
• Use longer chamfered taps			
Galling		• Use spiral point or spiral fluted taps	
		• Reduce number of flutes to provide extra chip room	
Operating Conditions	• Use National fine pitch, if applicable		
	• Use larger drill size		
	• If tapping a blind hole, allow deeper hole where applicable or shorten the thread length of the parts		
	• Use proper lubricant		
Oversize Internal Diameter	Drill Hole Size	• Apply proper surface treatment such as steamoxide	
		• Use proper cutting lubricant	
	Galling	• Reduce tapping speed	
		• Use proper cutting angle in accordance with material being tapped.	
Tool Conditions	• Use larger drill size		
	Galling	• Apply proper tapping speed	
		• Correct alignment of tap and drill hole	
		• Free cutting either tap or workpiece	
• Use proper tapping speed to avoid torn or rough thread			
Galling	• Use lead screw tapper		
	• Use proper tapping machine with suitable power		
	• Avoid misalignment of tap and drill hole from loose spindle or worn holder		
	• Obtain proper indexing angle for the flutes at the cutting edge		
Galling	• Grind proper indexing angle and chamfer angle		
	• Avoid too narrow land width		
	• Remove burrs from reground edge		
	• Use minimum size drill hole		
Galling	• Avoid tapered hole		
	• Use proper chamfered taps		
Galling	• Galling solutions 1 through 4 above can be applied to this specific problem		

Technical Data

DRILLS

DRILLS Cutting Condition

END MILLS

END MILLS Cutting Condition

TAPS

TAPS Cutting Condition

Others

	Troubles	Factors	Countermeasures
Dimensional Error	Undersize Pitch Diameter	Incorrect Tap Selection	<ul style="list-style-type: none"> • Use one oversize taps 1) Use for cuffing materials such as copper alloy, aluminum alloy, and cast iron 2) Use for cuffing tubing which will have "spring back" action after tapping • Apply proper chamfer angle • Increase cutting angle
		Damaged Thread	<ul style="list-style-type: none"> • Use proper reversing speed to avoid damaging tapped thread on the way out of the hole
		Left over Chips	<ul style="list-style-type: none"> • Increase cutting performance to avoid any leftover chip in the hole • Remove leftover chip from the hole for gauge checking
	Undersize Internal Diameter	Drill Hole size	<ul style="list-style-type: none"> • Use maximum drill size
Tool Life	Breakage	Incorrect Tap Selection	<ul style="list-style-type: none"> • Use high speed steel taps • Avoid chip packing in the flutes or the bottom of hole • Use spiral pointed or spiral fluted taps or Roll Taps • Apply correct surface treatment such as steam oxide or other coating
		Excessive Tapping Torque	<ul style="list-style-type: none"> • Use larger drill size • Try to shorten thread length • Apply National Fine Pitch if applicable • Increase cutting angle • Apply a tap with more thread relief and reduced land width • Use spiral pointed or spiral fluted taps
		Operating Conditions	<ul style="list-style-type: none"> • Reduce tapping speed • Avoid misalignment between tap and the hole and tapered hole • Use floating type of tapping holder • Use tapping holder with torque adjustment • Avoid hitting bottom of the hole with tap
		Tool Condition	<ul style="list-style-type: none"> • Do not grind the bottom of the flutes • Avoid too narrow a land width • Do not leave sections on the reground flutes which tapping wear still remains • Regrind tool more frequently
	Chipping	Incorrect Tap Selection	<ul style="list-style-type: none"> • Reduce cutting angle • Use a different kind of high speed steel taps • Reduce hardness of the taps • Increase chamfer length • Avoid chip packing in the flutes or the bottom of the hole by using spiral pointed or fluted taps
		Operating Conditions	<ul style="list-style-type: none"> • Reduce tapping speed • Avoid misalignment between tap and hole • Avoid sudden return or reverse in blind hole tapping • Avoid galling • Use larger drill size
	Wear	Incorrect Tap Selection	<ul style="list-style-type: none"> • Apply specially designed taps for tapping heat treated material • Change to a type of high speed steel material contained vanadium • Apply special surface treatment such as nitriding or TiN • Increase chamfer length
		Operating Conditions	<ul style="list-style-type: none"> • Reduce tapping speed • Apply proper cutting lubricants • Avoid work hardened hole • Use larger drill size
		Tool Condition	<ul style="list-style-type: none"> • Grind proper cutting angle • Avoid hardness reduction from grind process

Technical Data

DRILLS

DRILLS Cutting Condition

END MILLS

END MILLS Cutting Condition

TAPS

TAPS Cutting Condition

Others

MATERIAL SYMBOL CHART BY STANDARD

Description	U.S.A.		Japan	Germany	ISO
	ASTM	AISI	JIS	DIN	
Pipe Steel	1026 1025 1026		STS480 STKM12A STKM12C STKM13B STKM14B	St52.4	R33
	1050		STKM14C STKM15A STKM15C STKM16A STKM16C STKM17A STKM17C STKM18A STKM18B STKM20A		R50
Heat Resistant steel	S65007		SUH1 SUH3 SUH4 SUH11 SUH21 SUH31 SUH35 SUH36 SUH37 SUH38 SUH309 SUH310 SUH330 SUH409 SUH409L		
	S63008 S63017 S30900 S31000 N08330 S40900 S44600 S42200 S66286 R30155		SUH446 SUH600 SUH616 SUH660 SUH661	X6CrTi12	1Ti H7
Free cutting steel		1110 1108 1212 1213	SUM11 SUM12 SUM21 SUM22 SUM22L SUM23 SUM23L		9S20 11SMn28 11SMnPb
		1215 12L14 1117 1137 1141 1144	SUM24L SUM25 SUM31 SUM31L SUM32 SUM41 SUM42 SUM43	9SMn28 9SMnPb28 9SMnPb28 9SMn36 15S10	11SMnPb28 12SMn35 44SMn28
Spring steel		1075 1078	SUP3		1
		9260 5155 5160 6150 51B60	SUP6 SUP7 SUP9 SUP9A SUP10 SUP11A SUP12 SUP13	55Cr3 50CrV4 54SiCr6	1 1 5 9 7 4 8
Stainless steel	S30400 S40500 S42020 S43000 S44002 S17400 S17700 S41000		SUS304 SUS405 SUS420F SUS430 SUS440A SUS630 SUS631 SUS410	X5CrNi1810 X6CrAl13 X6Cr17 X7CrNiAl177 X10Cr13	11 2 8 1 2 3
	Cast steel	HT	SCH15		
Cast Iron	40 45		FC250 FC300		
	Ductile Cast Iron	60-40-18 80-55-06	FCD400 FCD600	GGG-60	
Aluminum Alloy			A1080 A1070 A1050 A1100 A1200 A2014 A2017 A2017 A2024BD A2024BE A2024 P	Al99.8 Al99.7 Al99.5 Al99 AlCuSiMn AlCuMg1 AlCuSiMn AlCuMg2 AlCuMg2 EN AW-2024	Al99.5 Al99.0Cu Al99.0 Al-Cu4SiMg Al-Cu4MgSi Al-Cu4SiMg AlCu4Mg1 AlCu4Mg1 AlCu4Mg1

Description	U.S.A.		Japan	Germany	ISO
	ASTM	AISI	JIS	DIN	
Aluminum Alloy	2024 2024 2024 2024 3003 5052 5052		A2024 S A2024 TD A2024 TE A2024 W A3003 A5052 BD A5052 BE A5052 FH A5052 P A5052 S A5052 TD A5052 TE A5052 W A5056 A5083 A6061 A6063	AlCuMg2 AlCuMg2 AlCuMg2 AlCuMg2 AlMg2.5 EN AW-5052	AlCu4Mg1 AlCu4Mg1 AlCu4Mg1 AlMg2.5 AlMg2.5
	5083 6061 6063 7075 7075 7075 7075 7075 7075 7075		7075 7075 BD 7075 BE 7075 FD 7075 FH 7075 P 7075 S 7075 TD 7075 TE	AlMg2.5 AlMg5 AlMg4.5Mn AlZnMgCu1.5 AlZnMgCu1.5 AlZnMgCu1.5 AlZnMgCu1.5 EN AW-7075 AlZnMgCu1.5 AlZnMgCu1.5 AlZnMgCu1.5	AlMg2.5 Al-Mg4.5Mn0.7 Al-Mg1SiCu Al-Mg0.7Si AlZn5.5MgCu AlZn5.5MgCu AlZn5.5MgCu AlZn5.5MgCu
Aluminum Alloy Casting	295.0 204.0		AC1A AC1B AC2A AC2B AC3A AC4A AC4B AC4C AC4CH AC4D AC5A AC7A AC7B AC8A AC8B AC8C AC9A AC9B ADC1 ADC3 ADC5 ADC6 ADC10 ADC10Z ADC12 ADC12Z ADC14	G(GK)-AlCu4Ti G(GK)-AlCu4TiMg G(GK)AlSi2 G(GK)-AlSi10Mg G(GK)-AlSiCu3 G(GK)AlSi7Mg G(GK)-AlMg5 GD-AlSi12(Cu) GD-AlSi10Mg GD-AlMg9 GD-AlSi9Cu3 GD-AlSi9Cu3	Al-Cu4MgTi Al-Si5Cu3 Al-Si6Cu4 Al-Si12 Al-Si10Mg Al-Si7Mg Al-Si7Mg Al-Si5Cu1Mg Al-Cu4Ni2Mg2 Al-Mg10 Al-Si2CuFe Al-Si10Mg Al-Si8Cu3Fe Al-Si9Cu3Fe
	319.0 333.0 356.0 A356.0 355.0 242.0 514.0 520.0 336.0		332.0 A413.0 A360.0 518.0 A380.0 A380.0 383.0 383.0 A390.0		
Magnesium Alloy	AZ91A AZ91B AZ91D AZ60A AZ60B AZ41A AZ80A AM20A AM50A AM60B AS22A AS41B AE42A		MD1A MD1B MD1D MB3 MD2B	DG-MgAl9Zn1 DG-MgAl9Zn1 MgAl8Zn	Mg-Al8Zn
	Copper, Copper Casting	C10200(B187:94) C10200(B152:94) C10200(B152:94)	C1020 B C1020 P C1020 R	OF-Cu OF-Cu OF-Cu	Cu-OF Cu-OF Cu-OF
Brass, Brass Casting	C26000(B36:95) C26000(B36:95) C26000(B36:95)		C2600 B C2600 P C2600 R	CuZn30 17660:83 CuZn30 17660:83 CuZn30 17670:83	4261/83 CuZn30 4261/83 CuZn30 4261/83 CuZn30
	C26000(B135:95) C26000(B134:93)		C2600 T C2600 W	CuZn30 17670:83 CuZn30	CuZn30 CuZn30
Bronze, Bronze Casting	C61400(B169:95)		C6140 P		428:83 CuAl 8Fe3

Technical Data

DRILLS

DRILLS
Cutting Condition

END MILLS
Cutting Condition

END MILLS
Cutting Condition

TAPS

TAPS
Cutting Condition

Others

COMPARISON CHART SCALE FOR HARDNESS

Approximate relationship between various hardness scales

	(HRC) Rockwell hardness C scale 150kg Brale	(HV) Diamond Pyramid hardness number, Vickers	(HB) Brinell hardness 29.42kN			Rockwell hardness			Rockwell hardness			(Hs) Shore scleroscope hardness number	Approx. tensile strength N/mm ²	(HRC) Rockwell hardness C scale 150kg Brale
			Standard 10mm ball	Hultgren 10mm ball	Tungsten carbide 10mm	(HRA)	(HRB)	(HRD)	15N	30N	45N			
						A scale 588.4N (60kg) Brale	B scale 980.7N (100kg) 1/16" in Ball	D scale 980.7N (100kg) Brale	Superficial Load 147.1N	Superficial Load 294.2N	Superficial Load 441.3N			
	68	940	—	—	—	85.6	—	76.9	93.2	84.4	75.4	97	—	68
	67	900	—	—	—	85.0	—	76.1	92.9	83.6	74.2	95	—	67
	66	865	—	—	—	84.5	—	75.4	92.5	82.8	73.3	92	—	66
	65	832	—	—	739	83.9	—	74.5	92.2	81.9	72.0	91	—	65
	64	800	—	—	722	83.4	—	73.8	91.8	81.1	71.0	88	—	64
	63	772	—	—	705	82.8	—	73.0	91.4	80.1	69.9	87	—	63
	62	746	—	—	688	82.3	—	72.2	91.1	79.3	68.8	85	—	62
	61	720	—	—	670	81.8	—	71.5	90.7	78.4	67.7	83	—	61
	60	697	—	613	654	81.2	—	70.7	90.2	77.5	66.6	81	—	60
	59	674	—	599	634	80.7	—	69.9	89.8	76.6	65.5	80	—	59
	58	653	—	587	615	80.1	—	69.2	89.3	75.7	64.3	78	—	58
	57	633	—	575	595	79.6	—	68.5	88.9	74.8	63.2	76	—	57
	56	613	—	561	577	79.0	—	67.7	88.3	73.9	62.0	75	—	56
	55	595	—	546	560	78.5	—	66.9	87.9	73.0	60.9	74	2079	55
	54	577	—	534	543	78.0	—	66.1	87.4	72.0	59.8	72	2010	54
	53	560	—	519	525	77.4	—	65.4	86.9	71.2	58.6	71	1952	53
	52	544	500	508	512	76.8	—	64.6	86.4	70.2	57.4	69	1883	52
	51	528	487	494	496	76.3	—	63.8	85.9	69.4	56.1	68	1824	51
	50	513	475	481	481	75.9	—	63.1	85.5	68.5	55.0	67	1755	50
	49	498	464	469	469	75.2	—	62.1	85.0	67.6	53.8	66	1687	49
	48	484	451	455	455	74.7	—	61.4	84.5	66.7	52.5	64	1638	48
	47	471	442	443	443	74.1	—	60.8	83.9	65.8	51.4	63	1579	47
	46	458	432	432	432	73.6	—	60.0	83.5	64.8	50.3	62	1530	46
	45	446	421	421	421	73.1	—	59.2	83.0	64.0	49.0	60	1481	45
	44	434	409	409	409	72.5	—	58.5	82.5	63.1	47.8	58	1432	44
	43	423	400	400	400	72.0	—	57.7	82.0	62.2	46.7	57	1383	43
	42	412	390	390	390	71.5	—	56.9	81.5	61.3	45.5	56	1334	42
	41	402	381	381	381	70.9	—	56.2	80.9	60.4	44.3	55	1294	41
	40	392	371	371	371	70.4	—	55.4	80.4	59.5	43.1	54	1245	40
	39	382	362	362	362	69.9	—	54.6	79.9	58.6	41.9	52	1216	39
	38	372	353	353	353	69.4	—	53.8	79.4	57.7	40.8	51	1177	38
	37	363	344	344	344	68.9	—	53.1	78.8	56.8	39.6	50	1157	37
	36	354	336	336	336	68.4	(109.0)	52.3	78.3	55.9	38.4	49	1118	36
	35	345	327	327	327	67.9	(108.5)	51.5	77.7	55.0	37.2	48	1079	35
	34	336	319	319	319	67.4	(108.0)	50.8	77.2	54.2	36.1	47	1059	34
	33	327	311	311	311	66.8	(107.5)	50.0	76.6	53.3	34.9	46	1030	33
	32	318	301	301	301	66.3	(107.0)	49.2	76.1	52.1	33.7	44	1000	32
	31	310	294	294	294	65.8	(106.0)	48.4	75.6	51.3	32.5	43	981	31
	30	302	286	286	286	65.3	(105.5)	47.7	75.0	50.4	31.3	42	951	30
	29	294	279	279	279	64.7	(104.5)	47.0	74.5	49.5	30.1	41	932	29
	28	286	271	271	271	64.3	(104.0)	46.1	73.9	48.6	28.9	41	912	28
	27	279	264	264	264	63.8	(103.0)	45.2	73.3	47.7	27.8	40	883	27
	26	272	258	258	258	63.3	(102.5)	44.6	72.8	46.8	26.7	38	863	26
	25	266	253	253	253	62.8	(101.5)	43.8	72.2	45.9	25.5	38	843	25
	24	260	247	247	247	62.4	(101.0)	43.1	71.6	45.0	24.3	37	824	24
	23	254	243	243	243	62.0	100.0	42.1	71.0	44.0	23.1	36	804	23
	22	248	237	237	237	61.5	99.0	41.6	70.5	43.2	22.0	35	785	22
	21	243	231	231	231	61.0	98.5	40.9	69.9	42.3	20.7	35	775	21
	20	238	226	226	226	60.5	97.8	40.1	69.4	41.5	19.6	34	755	20
	(18)	230	219	219	219	—	96.7	—	—	—	—	33	736	(18)
	(16)	222	212	212	212	—	95.5	—	—	—	—	32	706	(16)
	(14)	213	203	203	203	—	93.9	—	—	—	—	31	677	(14)
	(12)	204	194	194	194	—	92.3	—	—	—	—	29	647	(12)
	(10)	196	187	187	187	—	90.7	—	—	—	—	28	618	(10)
	(8)	188	179	179	179	—	89.5	—	—	—	—	27	598	(8)
	(6)	180	171	171	171	—	87.1	—	—	—	—	26	579	(6)
	(4)	173	165	165	165	—	85.5	—	—	—	—	25	549	(4)
	(2)	166	158	158	158	—	83.5	—	—	—	—	24	530	(2)
	(0)	160	152	152	152	—	81.7	—	—	—	—	24	520	(0)

In the above chart, figures with () are not commonly used.

Technical
Data

DRILLS

DRILLS
Cutting
Condition

END MILLS

END MILLS
Cutting
Condition

TAPS

TAPS
Cutting
Condition

Others



CUTTING TOOL PRODUCTS

NACHI AMERICA INC.

HEADQUARTERS AND MAIN WAREHOUSE

715 Pushville Road, Greenwood, Indiana, 46143, U.S.A.

Phone: 317-530-1003 Toll Free Phone: 1-888-340-8665

Fax: 317-530-1013 Toll Free Fax: 1-888-383-8665

Web Site URL : <http://www.nachiamerica.com>

WEST COAST BRANCH

12652 E. Alondra Blvd. Cerritos, California, 90703, U.S.A

Phone: 562-802-0055 Toll Free Phone: 1-800-548-3903

Fax: 562-802-2455

NACHI CANADA INC.

TORONTO HEADQUARTERS

89 Courtland Ave., Unit No.2, Concord, Ontario L4K 3T4, CANADA

Phone: 905-660-0088 Toll Free Phone: 1-800-387-9188

Fax: 905-660-1146

MONTREAL BRANCH

9730 Trans-Canada Hwy., St. Laurent, Quebec H4S 1V9, CANADA

Phone: 514-856-2200 Toll Free Phone: 1-888-622-4411

Fax: 514-856-9144

NACHI MEXICANA, S.A. DE C.V.

Urbina No.54, Parque Industrial Naucalpan, Naucalpan de Juarez, Estado de Mexico C.P. 53370, MEXICO

Phone: +52-55-3604-0832/0842/0081

Fax: +52-55-3604-0882

NACHI'S OTHER QUALITY PRODUCTS

BROACH/GEAR TOOLS

Phone: 317-530-1004

Fax: 317-530-1014

MACHINERY

Phone: 317-530-1007

Fax: 317-530-1015

BEARINGS

Phone: 317-530-1002 Toll Free Phone: 1-888-340-2747

Fax: 317-530-1012 Toll Free Fax: 1-888-734-1206

HYDRAULICS

Phone: 317-530-1005 Fax: 317-530-1015 Toll Free Phone: 1-800-622-4410

MATERIALS

Phone: 317-530-1006 Fax: 317-530-1015 Toll Free Phone: 1-800-526-6281

ROBOTICS

Phone: 248-305-6545 Fax: 248-305-6542

NACHI-FUJIKOSHI CORP.

Tokyo Head Office

Shiodome Sumitomo Bldg, 17F, 1-9-2 Higashi-Shinbashi, Minato-ku, Tokyo, JAPAN

Phone: +81-3-5568-5240 Fax: +81-3-5568-5236

Web Site URL <http://www.nachi-fujikoshi.co.jp/>

Toyama Head Office

1-1-1 Fujikoshi-Honmachi, Toyama, JAPAN

Phone: +81-76- 423-5111 Fax: +81-76- 493-5211

Purchase These Fine Products From